

NEC



XEN IPK

FEATURES & SPECIFICATIONS MANUAL

NEC Business Solutions Ltd

Document No.: 8201

Release 1.0

July 2003

THIS PAGE INTENTIONALLY LEFT BLANK

Preface & Disclaimer

GENERAL INFORMATION

The Xen IPK System is a feature-rich key system that provides over 200 features including Computer Telephony Integration, Least Cost Routing, Automatic Call Distribution, ISDN Trunks and many others.

The Xen IPK system meets customer needs today and as business expands the system can be expanded to grow as well.

The Xen IPK system has a set of manuals that provide all the information necessary to install and support the system. The manuals are described in this preface.

THIS MANUAL

This manual provides specific detailed information and specifications for all features provided with the Xen IPK system for Australia.

SUPPORTING DOCUMENTS

Xen IPK General Description Manual

This Manual provides general information about the system, its features, system configuration and standards. This manual provides an overview of the Xen IPK System and can be used to present information to potential customers.

Xen IPK System Hardware Manual

The System Hardware Manual is provided for the system installer. This manual has detailed instructions for installing the Xen IPK system KSUs, ETUs, Multiline Terminals, and optional equipment.

Xen IPK System Programming Manual

This manual provides instructions for programming the Xen IPK and Axis system via a Multiline Terminal or PC.

Xen IPK Least Cost Routing Manual

This manual provides instructions to the service technician for programming the customer site for least cost routing.

Xen IPK Automatic Call Distribution Manual

This manual provides the service technician with instructions for programming the ACD. This manual can also be used by the ACD supervisor, at the customer site, to use to become familiar with the ACD/MIS feature.

NEC shall not be liable for any direct, indirect, consequential or incidental damages about the use of this equipment, manual or any related materials.

The information in this technical manual is advisory in nature and is subject to change. NEC may make improvements and changes in the products described in this manual without notice. Changes will be periodically made to the information in the new editions.

Efforts have been made to ensure that the contents of this manual are correct. Should you find any error, NEC welcomes your comments to improve our communications, please contact NEC on 1800 036 136.

Contents of this manual are subject to change without prior notice at the discretion of NEC Business Solutions Ltd.

This document has been prepared for the use of employees and customers of NEC Business Solutions Ltd and may not be reproduced without the prior, written approval of NEC Business Solutions Ltd.

Copyright 2003

NEC Business Solutions Ltd
635 Ferntree Gully Road
Glen Waverley Vic 3150

Table of Contents

Chapter 1	Regulatory Information	1
SECTION 1	Electromagnetic Interference (EMI)	1
SECTION 2	Incidence of Harm	1
SECTION 3	Hearing Aid Compatibility	1
SECTION 4	Service Requirements	1
SECTION 5	Compliance Information	2
SECTION 6	Voice Announcement/Monitoring	2
SECTION 7	Music on Hold	2
SECTION 8	UL Regulatory Information	2
SECTION 9	Battery Disposal	3
Chapter 2	Introduction	5
SECTION 1	General Information	5
SECTION 2	Multiline Terminals Used With The System	5
Chapter 3	Features	9
SECTION 1	General Information	9
SECTION 2	Operating Procedures	10
SECTION 3	Features	10
A-1	Account Code Entry	11
A-2	Account Code - Forced/Unverified	15
A-3	Account Code - Forced/Verified	19
A-4	Add-On Conference	23
A-5	All Call Page	25
A-6	Alphanumeric Display	29
A-7	Ancillary Device Connection	33
A-8	Answer Hold	35
A-9	Answer Key	37
A-10	Assigned Night Answer (ANA)	39
A-11	Attendant Add-On Console	43

A-12	Attendant Camp-On	49
A-13	Attendant Positions	53
A-14	Attendant Station Outgoing Lockout	55
A-15	Attendant Transfer	59
A-16	Authorisation Code	61
A-17	Automatic Answer with Delay Message	65
A-18	Automated Attendant	71
A-19	Automatic Callback	79
A-20	Automatic Call Distribution (ACD)	81
A-21	Automatic Call Distribution (ACD Plus)	87
A-22	Automatic Carrier Routing	95
A-23	Automatic Day/Night Mode Switching	99
A-24	Automatic Hold	101
A-25	Automatic Redial	103
A-26	Automatic Release	107
A-27	Automatic Trunk-to-Trunk Transfer	109
B-1	Background Music - Multiline Speaker	113
B-2	Background Music Over External Speakers	115
B-3	Barge-In	117
B-4	Battery Backup - System Memory	121
B-5	Battery Backup - System Power	123
B-6	Busy Lamp Field on Multiline Terminals	125
C-1	Call Alert Notification	129
C-2	Call Appearance Keys (CAP)	133
C-3	Call Arrival Keys (CAR)	137
C-4	Callback Request	141
C-5	Caller ID Call Return	145
C-6	Caller ID - Incoming	151
C-7	Caller ID - Outgoing	157
C-8	Call Forward - All Calls	161
C-9	Call Forward - Busy/No Answer	167
C-10	Call Forward - Display	171
C-11	Call Forward - Off-Premise	173
C-12	Call Forward - Split	179
C-13	Call Park - System	183
C-14	Call Pickup Direct	187
C-15	Call Pickup Group	191
C-16	Centralised Voice Mail	195
C-17	Class of Service	201
C-18	Clock/Calendar Display	207
C-19	Code Restriction	209

C-20	Code Restriction Password Override	213
C-21	CO/PBX, Tie Line Digit Restriction	217
C-22	Computer Telephony Integration (CTI)	219
C-23	Consecutive Speed Dial	221
C-24	Cordless Telephone Connection	223
C-25	Customised Message	227
D-1	Data Line Security	231
D-2	Delay Announcement	233
D-3	Delayed Ringing	237
D-4	Dial 9 For Attendant	239
D-5	Dialled Number Identification Service (DNIS)	241
D-6	Digit Insertion	245
D-7	Digital Voice Mail	247
D-8	Direct Inward Dialling (DID)	257
D-9	Direct Inward System Access (DISA)	263
D-10	Direct Inward Termination (DIT)	269
D-11	Direct Paging Access	271
D-12	Direct Station Selection	273
D-13	Distinctive Ringing	275
D-14	Do Not Disturb (DND)	279
D-15	Door Lock Release Relays	283
D-16	Door/Monitor Telephone	285
D-17	DP to DTMF Switching	287
D-18	Drop Key	289
D-19	Dterm Series i Multiline Terminals	291
D-20	DTU-type Multiline Terminal Migration	297
E-1	Elapsed Call Timer	299
E-2	Electronic Volume Control	301
E-3	E&M Tie Lines (4-Wire)	305
E-4	Equal Access Accommodation	309
E-5	External Tone Ringer	311
E-6	External Zone Paging (Meet-Me)	313
F-1	Feature Access – User Programmable	317
F-2	Flexible Line Assignment	321
F-3	Flexible Numbering Plan	323
F-4	Flexible Ringing Assignment	325
F-5	Flexible Timeouts	327
F-6	Full Duplex Handsfree	331
F-7	Full Handsfree Operation	333
G-1	General Purpose Relays	335

G-2	Group Listening	337
H-1	Handset Mute	339
H-2	Handsfree Answerback	341
H-3	Handsfree Dialling and Monitoring	343
H-4	Headset Connection (Built In)	345
H-5	Hold With Recall (Exclusive & Non-Exclusive)	347
H-6	Hot Line	351
H-7	Howler Tone Service	353
I-1	I-Hold Indication	355
I-2	Incoming Call Identification	357
I-3	Intercom By-Pass CO Call	359
I-4	Internal Voice/Tone Signalling	361
I-5	Intercom Function	363
I-6	Internal Zone Paging (Meet Me)	367
I-7	ISDN-BRI Trunk Connections	371
I-8	ISDN-PRI Trunk Connections	377
I-9	ISDN Supplementary Services	385
I-10	I-Use Indication	387
K-1	Key Function/Multifunction Registration	389
L-1	Large LED Indication	391
L-2	Last Number Redial	393
L-3	Least Cost Routing (LCR)	395
L-4	Live Monitoring	399
L-5	Loop Start Trunks	403
M-1	Message Waiting	405
M-2	Microphone Control	407
M-3	Multiline Conference Bridge	411
M-4	Multilingual LCD Indication	415
M-5	Multiple Trunk Groups	417
M-6	Multi-Zone Digital Cordless	419
M-7	Music on Hold	427
N-1	Nesting Dial	431
N-2	Night Call Pickup	435
N-3	Night Chime	437
N-4	Night Transfer	439
O-1	Off-Hook Ringing	443
O-2	Off-Premise Extension	445
O-3	One-Touch/Feature Access Key	447
P-1	PC Attendant Console	449
P-2	PC Programming	453
P-3	Pooled Line (Outgoing)	455

P-4	Power Failure Transfer	457
P-5	Preset Dialling	459
P-6	Prime Line Assignment	461
P-7	Privacy on All Calls	463
P-8	Privacy Release	465
P-9	Private Lines	469
P-10	Programming from Multiline Terminal	471
P-11	Push Button Dial - DTMF or DP	473
Q-1	Quick Transfer to Voice Mail	475
R-1	Recall Key	479
R-2	Recall With Station Identification	483
R-3	Redial Key	485
R-4	Remote Programming	487
R-5	Resident System Program	489
R-6	Restriction (Outgoing)	491
R-7	Ringing Line Preference	493
R-8	Ring Tone Variation	495
R-9	Route Advance Block	497
S-1	Save and Repeat	499
S-2	Scrolling Directories	501
S-3	Secondary Incoming Extension	505
S-4	Seized Trunk Name/Number Display	507
S-5	Simplified Call Distribution	509
S-6	Single Line Telephone Access	511
S-7	SLT Adapter	515
S-8	SLT Timed Alarm	517
S-9	Softkeys	519
S-10	Speed Dial – Station	521
S-11	Speed Dial Stored Characters	525
S-12	Speed Dial – System	529
S-13	Station Camp-On	533
S-14	Station Hunting	535
S-15	Station Message Detail Recording (SMDR)	539
S-16	Station Name/Number Display	545
S-17	Station Outgoing Lockout	547
S-18	Station Relocation	551
S-19	Station Transfer	555
S-20	Step Call	557
S-21	Store and Repeat	559
S-22	Stored Hookflash	561

S-23	Synchronous Ringing	565
S-24	System Data Up/Down Load	567
T-1	Tandem Switching of 4-Wire E&M Tie Lines	569
T-2	Tenant Service	573
T-3	Three-Minute Reminder	575
T-4	Tone Override	577
T-5	Trunk Queuing	579
T-6	Trunk-to-Trunk Transfer	583
T-7	Two-Colour LEDs	585
U-1	Uniform Call Distribution (UCD)	587
U-2	Uniform Numbering Network	593
U-3	Universal Slots	597
U-4	Unsupervised Conference	603
U-5	User Programming Ability	605
V-1	Voice Mail Integration (Analogue)	607
V-2	Voice Mail Message Key	611
V-3	Voice Over Internet Protocol (VoIP)	615
V-4	Voice Over Split	619
V-5	Voice Prompt	623

Chapter 4 Feature Access Codes..... 627

SECTION 1	General Information	627
-----------	---------------------------	-----

SECTION 1

ELECTROMAGNETIC INTERFERENCE (EMI)

WARNING

This is a Class A product. In a domestic environment this product may cause radio interference in which case the user may be required to take adequate measures.

SECTION 2

INCIDENCE OF HARM

If the System is malfunctioning, it may also be causing harm to the telephone network. The Telephone system should be disconnected until the source of the problem can be determined and until repair has been made. If this is not done, the Network Provider may temporarily disconnect the service.

SECTION 3

HEARING AID COMPATIBILITY

The NEC Multiline Terminals that are provided for this system are hearing aid compatible. The manufacturer of Single Line Telephones for use with the system must provide notice of hearing aid compatibility to comply with ACA Technical Standards.

SECTION 4

SERVICE REQUIREMENTS

WARNING

This equipment must only be installed and maintained by service personnel.

In the event of equipment malfunction, all repairs must be performed by an authorised dealer of NEC Business Solutions Ltd or by NEC Business Solutions Ltd. It is the responsibility of users requiring service to report the need for service to one of NEC Business Solutions Ltd authorised agents or to NEC Business Solutions Ltd.

SECTION 5

COMPLIANCE INFORMATION

This equipment has been tested to comply with all relevant ACA Technical Standards.

The *D^{term}* Series i telephones are compliant with all relevant ACA Standards, but be aware that small metal objects such as staples and pins may become caught and held in the earpiece, and users should be aware and careful to prevent any accident from such an event.

The Xen IPK KSU must be permanently connected to protective earth.

SECTION 6

VOICE ANNOUNCEMENT/ MONITORING

CAUTION

The use of monitoring, recording or listening devices to eavesdrop, monitor, retrieve or record telephone conversations or other sounds activities, whether or not contemporaneous with its transmission may be illegal in certain circumstances under federal or state laws. Legal advice should be sought prior to implementing any practice that monitors or records any telephone conversation. Some federal and state laws require some form of notification to all parties to the telephone conversation, such as using a beep tone or other notification methods, or require the consent of all parties to the telephone conversation, prior to monitoring or recording a telephone conversation. Some of these laws incorporate strict penalties.

SECTION 7

MUSIC ON HOLD

IMPORTANT NOTE

In accordance with Australian Copyright Law, a license may be required from The Australian Performing Right Association Limited (APRA), or other similar organisation, when radio or TV broadcasts are transmitted through the Music On Hold feature of this telecommunication system. NEC Business Solutions Ltd hereby disclaims any liability arising out of the failure to obtain such a license.

SECTION 8

UL REGULATORY INFORMATION

This equipment has been listed by Underwriters Laboratories and complies with all applicable requirements of the standard for telephone equipment UL 1459.

SECTION 9

BATTERY DISPOSAL

The Xen IPK system includes the batteries listed below. When disposing of these batteries, KSUs and/or ETUs, you must comply with applicable Federal and State regulations regarding proper disposal procedures.

The Xen IPK CPUI()-U() ETU provides memory backup for approximately 21 days. The Ni-Cd battery should be replaced about every two years.

IMPORTANT SAFEGUARDS FOR BATTERY DISPOSAL

DO NOT PLACE USED BATTERIES IN YOUR REGULAR TRASH! THE PRODUCT YOU PURCHASED CONTAINS A NICKEL-CADMIUM OR SEALED LEAD BATTERY. NICKEL-CADMIUM OR SEALED LEAD BATTERIES MUST BE COLLECTED, RECYCLED OR DISPOSED OF IN AN ENVIRONMENTALLY SOUND MANNER.

The incineration, landfilling or mixing of nickel-cadmium or sealed lead batteries with the municipal solid waste stream is PROHIBITED BY LAW in most areas. Contact your local solid waste management officials for other information regarding the environmentally sound collection, recycling and disposal of the battery.

Nickel-Cadmium (or sealed lead) batteries must be returned to a Federal or State approved nickel-cadmium (or sealed lead) battery recycler. This may be where the batteries were originally sold or a local seller of automotive batteries. Contact your local waste management officials for other information regarding the environmentally sound collection, recycling and disposal of the battery contained in this product.

Table 1-1: Battery Types and Quantities for KSUs and ETUs

Unit Name	Type of Battery	Quantity
B64-U() KSU	Lead Acid	2
CPUI()-U() ETU	Nickel-Cadmium	1
DTR-1HM-1A TEL	Lithium	1
MIFA-U() ETU	Nickel-Cadmium	1
MIFM-U() ETU	Nickel-Cadmium	1
VMS(2)/(4)/(8)-U33 ETU	Lithium	1
FMS(2)/(4)-U33 ETU	Lithium	1

THIS PAGE INTENTIONALLY LEFT BLANK

SECTION 1

GENERAL INFORMATION

D^{term} Series i (DTR telephones) and DTU-type multiline telephones can be used with the Xen IPK system.

SECTION 2

MULTILINE TERMINALS USED WITH THE SYSTEM

Dterm Series i Multiline Terminals

The D^{term} Series i Multiline Terminals offer a variety of colours, display and non-display and line sizes.

- ④ Two colours are generally available: black and white.
- ④ Two display types: with LCD and without LCD. The large Liquid Crystal Display (LCD) on the display terminals provides call status data and programming information.
- ④ Four line sizes: 2-line, 8-line, 16-line and 32-line.
- ④ Speakerphones with full handsfree operation and headset jacks are standard (headset jack not available on the DTR-2DT-1A).
- ④ All but the DTR-2DT-1A are compatible with the AD(A)-R(), AP(A)-R(), AP(R)-R(), CT(A)-R() Unit and CT(U)-R() Unit adapters. The AP(R)-R() Unit requires an ACA-U() Unit to supply AC power. The DTR-2DT-1A has an internal Analogue Port without ringer.
- ④ An Attendant Add-On DCR-60-1A CONSOLE is available with 60 station and/or outside line assignments and 12 function keys.
- ④ Two-line terminal with two Flexible Line keys (each with 2-colour LED), nine function keys, built-in speakerphone, a large LED to indicate incoming calls or messages, and an outgoing only Analogue Port for connecting a modem.

- ④ The Single Line Terminals are offered in two variations (DTR-1-1A and DTR-1HM-1A). Both have DTMF and Pulse Dialling compatibility, and offer Flash and Redial key functionality. These Single Line Terminals come standard with a Message Waiting Indicator that also functions as an Incoming Call Indication. During a call, the receive audio level can be increased three levels and decreased two levels from the default setting (six volume level settings in all). The terminals offer four ring volume settings (Off, Soft, Medium, and Loud), and three ring patterns (Slow, Medium, and Fast). The Single Line Terminals also have a Data Port for connecting a modem, and have a built-in wall mount adapter. The DTR-1HM-1A terminal has eight programmable speed dial buttons (maximum 21 digits each). The DTR-1HM-1A also has Hold and Monitor Function keys.

Dterm Series i Terminal Feature Access Single On/Off, or One-Touch Keys

Keys are designated Feature Access, Single On/Off, or One-Touch throughout this manual. The keys operate much the same, but various limitations imposed on each type are described below.

- ④ **Feature Access Keys**
Depending on the type, a Multiline Terminal can have 2, 8, 16, or 24 line keys. These highly-flexible keys can be used for station DSS/BLF and Speed Dial.
- ④ **Single On/Off Keys**
Line keys may also be assigned as Single On/Off keys in System Programming to toggle a feature on/off. This assignment has no impact on the Feature Access keys, but the assigned features are very specific. Call Forward All Call, Call Forward Busy/No Answer, Scrolling (CID), headset, and DND are examples of features available for Single On/Off keys.

One-Touch Keys

One-Touch keys can perform the same function as Feature Access keys. A Multiline Terminal has a fixed number of these keys. No system assignment is necessary, and the number of keys ranges from none to 16 depending on the terminal type.

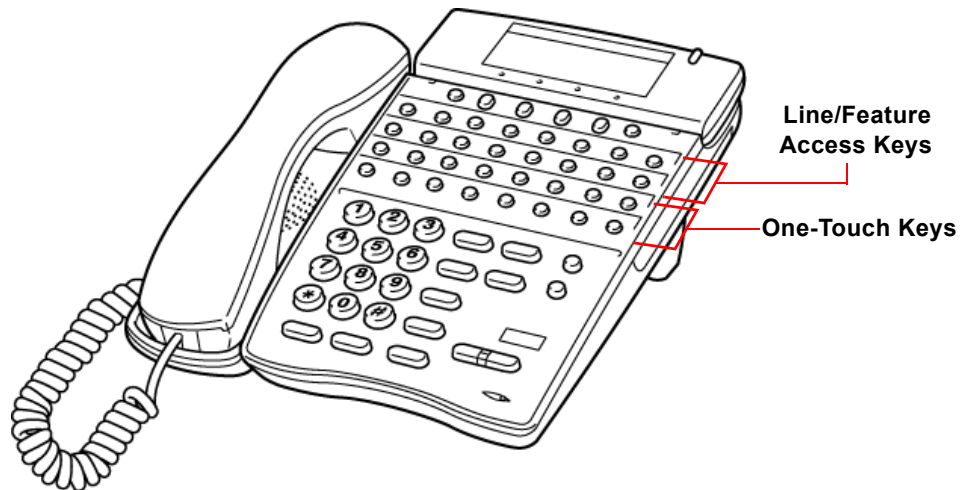

Figure 2-1: Key Assignment Example

DTU-type Multiline Terminals

- The DTU-type multiline telephones are available in a variety of colours, display and non-display types and line sizes.
- Two colours are generally available: black and white.
- Two display types: with LCD and without LCD. The large Liquid Crystal Display (LCD) on the display terminals provides call status data and programming information.
- Three line sizes: 8-line, 16-line and 32-line.
- Speakerphones with full handsfree operation and headset jacks are standard.
- The D^{term} Series i Handset Cordless terminal is a 16-button phone (display only).
- An Attendant Add-On DCU-60-1A(BK)/(WH) CONSOLE is available for 60 station and/or outside line assignments and 12 function keys.
- An SLT Adapter can be used in place of a digital terminal for connecting Single Line Telephones, or similar devices.

THIS PAGE INTENTIONALLY LEFT BLANK

SECTION 1 GENERAL INFORMATION

All features available with the Xen IPK system are listed alphabetically by name and described in this document. The following information is provided, when applicable, for each feature:

Feature Description — briefly describes the feature and, when applicable, tells how the feature is used by the end-user.

System Availability — describes Multiline Terminals that can be used with this feature and lists any additional equipment, such as adapters or ETUs, that must be installed for this feature to operate.

Operating Procedures – When applicable, detailed procedures for using the feature are provided.

Quick Access Code Reference – provides a table that lists any Access Codes that are used with the operation of the feature. This table is only included for those features that have associated Access Codes. This table has three columns: Default, Access Code Name, and Alphabetic Designation.

- ⓘ Default – indicates the default values for the Access Codes (i.e., the values as they are set when the system is first installed). All Access Codes can be changed in System Programming with the exception of the System and Fixed codes.
- ⓘ Access Code Name – indicates the name associated with the Access Code. At the end of each code name, in parenthesis, is the code type. There are four types of Access Codes: System, Feature, Intercom, and Fixed.
 - System Codes are usually 1-digit codes that apply to the operation of the system. These codes can be changed in System Programming.
 - Feature Codes are typically 3-digit codes and indicate Access Codes that apply to the associated feature, these codes can be changed in System Programming.
 - Intercom Codes are 2-digit codes that apply to the associated feature and indicate Access Codes that can be changed in System Programming.
 - Fixed Codes cannot be changed, they are set in the system.
- ⓘ Alphabetic Designation – helps you to easily remember the Access Code. It is the alphabetic equivalent of the Access Code. These designations are only available for Feature and Intercom codes.



























Service Conditions – provides specific conditions that apply to the operation of this feature.

Related Features Lists – lists any associated features.

SECTION 2 OPERATING PROCEDURES

The operating procedures are the same for the *D^{term}* Series i and DTU-Type and ETW-Type Multiline Terminals. The *D^{term}* Series i terminals have three additional keys; MIC, Directory and Message. Minor differences in the keys are listed below. **These differences are important when performing the operations listed in the remainder of this manual.**

Table 3-2: Comparison of Keys for *D^{term}* Series i and DTU-type Multiline Terminals

Dterm Series i Terminals		DTP or DTU Terminals
	⇒	
	⇒	
	⇒	
	⇒	
	⇒	
	⇒	
	⇒	
	⇒	
	⇒	
	⇒	
	⇒	
	⇒	
 Directory	⇒	N/A
 Message	⇒	N/A
 Mic	⇒	N/A

SECTION 3 FEATURES

Features that are available with the Xen IPK system are listed in the remainder of this chapter in alphabetical order by feature name.

Account Code Entry

A-1

FEATURE DESCRIPTION

The Account Code Entry feature allows assignment of Account Codes up to 16 digits. Account Codes are incorporated in the call records generated by the Station Message Detail Recording (SMDR) option and provide a reference for billing.

SYSTEM AVAILABILITY

Terminal Type

All terminals.

Required Components

MIFM-U() ETU

OPERATING PROCEDURES

From a Multiline Terminal with an outside call in progress:

1. Press **[Feature]**.
2. Dial Access Code **6** **6** (fixed Access Code).
3. Enter the Account Code using the dial pad while talking with the outside party.
4. Press **[Feature]**.

From a Multiline Terminal with an outside call on hold:

1. While receiving internal dial tone, dial Account Code Entry Access Code _____ (not assigned at default).
 2. Enter the Account Code using the dial pad.
 3. Retrieve the held call.
- OR -**
4. While receiving internal dial tone, press the Feature Access or One-Touch key programmed for Account Code Entry.
 5. Enter the Account Code using the dial pad.
 6. Retrieve the held call.

From a Single Line Telephone with an outside call in progress:

1. Press the hookswitch, and receive a new internal dial tone; the outside party is put on hold.
2. Dial Account Code Entry Access Code _____ (not assigned at default).
3. Enter the Account Code using the dial pad.
4. Provide a hookflash to return to the held call.

QUICK ACCESS CODE REFERENCE

Default	Access Code Name	Alphabetic Designation
66	Account Code Entry (Feature Access - Fixed)	N/A

SERVICE CONDITIONS

Data Assignment

- ④ The Account Code Entry Access Code, used after a call has been put on hold (no default is provided), can be changed in System Programming.
- ④ The ability to enter an Account Code is determined by System Programming.

Restrictions

- ④ No Account Code can be entered when a station is a member of a conference supported by the system.
- ④ A hookflash results in a conference when a Single Line Telephone has a call on hold and another call is in progress. In this case, an Account Code cannot be entered.
- ④ An Account Code Entry does not print with SMDR unless the account code is entered after the Call Start Time elapses.

General

- ④ SMDR Reports on incoming calls is dependent on System Programming. When an Account Code is entered during an outgoing call, a call report is generated regardless of system assignment.
- ④ Multiline Terminal users can enter an Account Code while talking with the outside party (no tones are sent to the CO line and the outside party is not put on hold).
- ④ If multiple Account Codes are entered during one call, the last entry is output from SMDR.
- ④ Account Code length can be up to 16 digits.
- ④ Account Codes can be programmed to a Feature Access or One-Touch key on any Multiline Terminal.
- ④ During Account Code Entry, Call Alert Notification is not provided.
- ④ SMDR card must be present and enclosed in system programming for account codes to work.

RELATED FEATURES LIST

Feature Number	Feature Name
A-2	Account Code - Forced/Unverified
A-3	Account Code - Forced/Verified
S-15	Station Message Detail Recording (SMDR)

GUIDE TO FEATURE PROGRAMMING

Order and Shortcut	System Data Name	Memory Block	Function	1-8-07 Attendant Page-Line Key	1-8-08 Station Page-Line Key
+BTS	* Class of Service (Station) Feature Selection 2	1-8-08			3-6
+BTT	* Station to Class of Service Feature Assignment	4-17			
+BA	Access Code (1-, 2-, or 3-Digit) Assignment	1-1-46/47/48	041		
+BS	Card Interface Slot Assignment	7-1			
+BS	MIF (SMDR) Assignment	7-3-02			
+BS	MIF (LCR) Assignment	7-3-01			
+AS	* Printer Connected Selection	1-5-13			
+AS	Printer Line Feed Control Selection	1-5-14			
+AS	SMDR Incoming/Outgoing Print Selection	1-5-26			
+AS	SMDR Valid Call Time Assignment	1-5-25			
+AS	SMDR Print Format	1-5-02			
+AS	SMDR Telephone Print Selection	4-56			
+CSS	COM Port Baud Rate Setting Assignment	1-8-35			
+BM	Start Time Selection	1-1-05			

* When the system is at default this Memory Block **must** be programmed for the feature to be used.

THIS PAGE INTENTIONALLY LEFT BLANK

Account Code - Forced/Unverified

A-2

FEATURE DESCRIPTION

The Forced/Unverified Account Code feature forces the user to dial an access code and an Account Code before being able to select an outside line, but the account code entered is not verified against a list of stored numbers (as it is in the Forced/Verified Account Code feature). This in effect means that any number (of a specified length) can be entered without being restricted to a certain selection only. The Account Code entered is then presented in the SMDR report at the end of the call for account keeping or identification purposes.

SYSTEM AVAILABILITY

Terminal Type

All Terminals

Required Components



MIFM-U() ETU

OPERATING PROCEDURE

To enter a Forced/Unverified Account Code from any station:

1. Lift the handset and wait for internal dial tone.
2. Dial the Forced Account Access Code. A second dial tone is received.
3. Dial the Forced/Unverified Account Code. Wait for internal dial tone.
4. Dial the Trunk Access code and the outside number.

To use this feature with Scrolling Directories:

1. Press the  (SYS. or STA softkey) to designate system or station speed dialling.
2. Press the  (UP or DOWN softkey) to view the names/numbers listed in the directory.

- OR -

Press a dial pad key (to select the first letter of the name or number of the desired speed dial buffer) and dial .

3. To dial the number press  or lift the handset.
4. Enter the Account Code.

SERVICE CONDITIONS

Data Assignment

- ④ Use Memory Block 1-8-08 [Class of Service (Station) Feature Selection 2], Page 6 LK3 to Allow (LED On) or Deny (default: LED Off) Forced Account Code Unverified.
- ④ Use Memory Blocks 1-1-46~48 [Access Code (1-, 2-, or 3-Digit) Assignment] to assign the Forced Account Code Access (Function No. 147).
- ④ Use Memory Block 1-8-27 (Forced Account Code Length Assignment) to assign the number of digits for Account Codes system-wide. One to 13 digits can be assigned; default is 10 digits.
- ④ Use Memory Block 7-1 (Card Interface Slot Assignment) to specify the necessary MIFM-U() ETU.

Restrictions

- ④ Existing Code restrictions, Automatic Carrier Routing (ACR) and Least Cost Routing (LCR) assignments are applied after Forced Account Codes are entered.
- ④ Emergency 000 (111 NZ) calls cannot be made unless a valid Forced Account Code is entered.
- ④ A one-touch key must be programmed on these handsets allowing emergency number access.
- ④ Verified and Unverified Forced Account Codes cannot be used in the same Class of Service.

















General





- ④ Only outgoing calls from Intercom require a Forced Account Code. Direct access to trunks bypasses this feature, that is, by pressing a line key, or dialling trunk access code.
- ④ The Forced Account Code without verification feature allows the user to place an outgoing call without Account Code verification only the length is verified.
- ④ Reorder tone is provided if an outgoing call is dialled without entering the Forced Account Code access code and a valid Forced Account Code.
- ④ Call Alert Notification is not provided during Account Code Entry.
- ④ PBR Timer values apply when using a Single Line Telephone to enter a Forced/Unverified Account Code.
- ④ Verified and Unverified Forced Account Codes will be printed on the SMDR report if both features are used.
- ④ An 'A' is placed in front of the Forced/Unverified Account Codes on the SMDR reports to distinguish them from other Account Code entries.
- ④ The Interdigit Timer (10sec) is applicable when a user inputs an Account Code. Busy Tone is received if the timer expires.

RELATED FEATURES LIST

Feature Number	Feature Name
A-1	Account Code Entry
A-3	Account Code - Forced/Verified
S-15	Station Message Detail Recording (SMDR)

GUIDE TO FEATURE PROGRAMMING

Order and Shortcut	System Data Name	Memory Block	Function	1-8-07 Attendant Page-Line Key	1-8-08 Station Page-Line Key
 +BA	* Access Code (1-, 2-, or 3-Digit) Assignment	1-1-46/47/48	146,147		
 +BTS	Class of Service (Attendant) Feature Selection 1	1-8-07		2-8	
 +BTS	* Class of Service (Station) Feature Selection 2	1-8-08			5-1, 6-3
 +AC	Code Restriction Class Assignment (Day Mode)	4-07			
 +AC	Code Restriction Class Assignment (Night Mode)	4-08			
 +BTT	* Station to Class of Service Feature Assignment	4-17			
 +AC	Code Restriction Class (Without Authorisation Code) Day Mode Assignment	4-64			
 +AC	Code Restriction Class (Without Authorisation Code) Night Mode Assignment	4-65			
 +BF	Forced Account Code Length Assignment	1-8-27			
 +BS	Card interface Slot Assignment	7-1			
 +BS	MIF (SMDR) Assignment	7-3-02			
 +BS	MIF (LCR) Assignment	7-3-01			
 +AS	* Printer Connected Selection	1-5-13			
 + AS	Printer Line Feed Control Selection	1-5-14			
 + AS	SMDR Incoming/Outgoing Print selection	1-5-26			
 + AS	SMDR Valid Call Time Assignment	1-5-25			

Order and Shortcut	System Data Name	Memory Block	Function	1-8-07 Attendant Page-Line Key	1-8-08 Station Page-Line Key
 +AS	SMDR Print Format	1-5-02			
 +AS	SMDR Telephone Print Selection	4-56			
 +CSS	COM Port Baud Rate Setting Assignment	1-8-35			
 +BM	Start Time Selection	1-1-05			

* When the system is at default this Memory Block **must** be programmed for the feature to be used.

Account Code - Forced/Verified

A-3

FEATURE DESCRIPTION

The Account Code - Forced/Verified feature forces selected station users to dial an Access Code and a verified Account Code before making an outgoing call. The outgoing call is processed only after the Dialed Account Code is verified. This feature allows a system administrator to control unauthorised outgoing calls. The Forced/Verified Account Code is part of the Station Message Detail Recording (SMDR) call record. The maximum number of digits for an Account Code is 13.

SYSTEM AVAILABILITY

Terminal Type

All Terminals.

Required Components



MIFM-U() ETU

OPERATING PROCEDURE



To enter a Forced/Verified Account Code from any station:

1. Lift the handset; receive internal dial tone.
2. Dial the Forced Account Access Code _____. (not assigned at default). A second dial tone is received.
3. Dial the Forced Account Code _____. Internal dial tone is received.
4. Dial the Trunk Access code and the outside number.

To program Forced/Verified Account Code from Attendant Position:

1. Lift the handset; receive internal dial tone.
2. Dial the Forced Account Access Code (not assigned at default). A second dial tone is received.
3. Dial the Forced Account Number (0 0 1 ~ 5_{JKL} 0 0).
4. Dial the Forced Account Code (default: 4 digits). Confirmation tone is received.
5. Press  to enter the information. The next Account Number is displayed. (Repeat steps 4 ~ 5 until all desired Account Codes are entered.)
6. Press  to finish entering Account Codes.

To use this feature with Scrolling Directories:

1. Press the  (SYS. or STA softkey) to designate system or station speed dialling.
2. Press the  (UP or DOWN softkey) to view the names/numbers listed in the directory.





- OR -

Press a dial pad key (to select the first letter of the name or number of the desired speed dial buffer) and dial  .

3. To dial the number press  or lift the handset.
4. Enter the Account Code.

SERVICE CONDITIONS

Data Assignment

-  Use Memory Block 1-8-07 [Class of Service (Attendant) Feature Selection 1] Page 2 LK8 to Allow (default LED On) or Deny (LED off) Attendant Positions to program Forced Account Codes.
-  Use Memory Block 1-8-08 [Class of Service (Station) Feature Selection 2] Page 5 LK1 to Allow (LED On) or Deny (default: LED Off) Account Code Forced/Verified.
-  Use Memory Block 1-8-27 (Forced Account Code Length Assignment) to assign the number of digits for Account Codes system-wide. One to 13 digits can be assigned; default is 4 digits.
-  Use Memory Block 7-1 (Card Interface Slot Assignment) to specify the necessary MIFM-U() ETU.

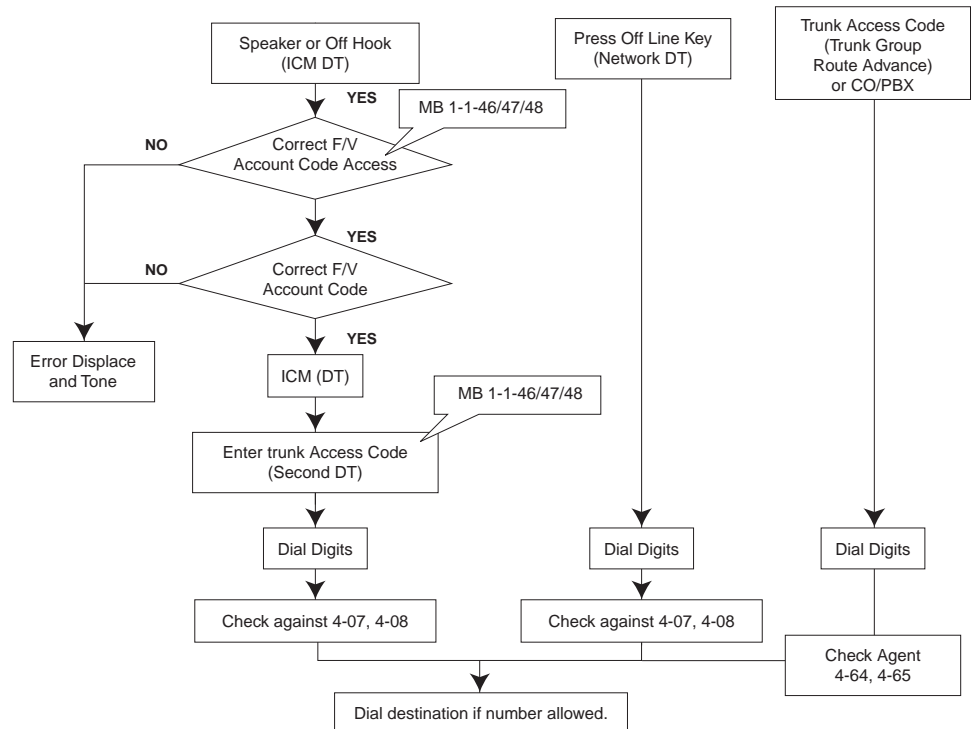

Figure A3-1: Account Code Forced/Verified

Restrictions

- ④ Existing restrictions and Least Cost Routing (LCR) assignments are applied after Forced Account Codes are entered.
- ④ Emergency 000 (111 NZ) calls cannot be made unless a valid Forced Account Code is entered. In such cases, provide access to emergency numbers by programming them into One-Touch or Feature Access keys.
- ④ Verified and Unverified Forced Account Codes cannot be used in the same class of service.

General

- ④ Only outgoing calls from an intercom require a Forced Account Access Code. Direct access to trunks bypasses this feature.
- ④ Reorder tone is provided if an outgoing call is Dialed without entering the Forced Account Access Code and a valid Forced Account Code.
- ④ Call Alert Notification is not provided during Account Code Entry verification and programming.
- ④ PBR Timer values apply when using a Single Line Telephone to enter a Forced/Verified Account Code.
- ④ Forced Account Codes can be uploaded, downloaded, or modified using PC based System Programming.
- ④ Forced Account Code and Account Code entries print on the SMDR report if both are used.

- ④ **A** is placed in front of the Forced Account Codes on the SMDR reports to distinguish them from other Account Code entries.
- ④ Attendant Positions can be used to program Forced Account Codes only if allow is assigned in Attendant Class of Service.
- ④ The maximum number of Forced Account Codes that can be entered system-wide is 500.
- ④ When the Interdigit time (default 10s) expires after the user inputs a Forced Account Code, busy tone is generated.

RELATED FEATURES LIST

Feature Number	Feature Name
A-1	Account Code Entry
A-2	Account Code - Forced/Unverified
S-15	Station Message Detail Recording (SMDR)

Add-On Conference

A-4

FEATURE DESCRIPTION

The Add-On Conference feature allows a conference call with a maximum of four parties with various combinations of outside lines and stations. This increases efficiency by allowing multiple parties to enter into a conversation.

Up to sixteen 4-party conferences are allowed with no more than two outside lines per conference.

SYSTEM AVAILABILITY

Terminal Type



All stations.

Required Components

None.

OPERATING PROCEDURES

To initiate an Add-On Conference using a Multiline Terminal with a call in progress:

1. Press .
2. Dial a station number or outside party, and inform the answering party of the conference.
3. Press  again. The  LED lights solid. Talk with both parties.
4. Repeat steps 1~3 to add an additional party to the conference.

To initiate an Add-On Conference using a Single Line Telephone with a call in progress:

1. Press the hookswitch to place the first call on hold.
2. Dial an internal station and announce conference.
3. Press the hookswitch again. Talk with both parties.

Note: Refer to Privacy Release, on Page 465 for a different method of entering conference.

SERVICE CONDITIONS

Restrictions

- Ⓢ A Single Line Telephone cannot be used to originate a 2-party CO conference.
- Ⓢ A Multiline Terminal user that is put on hold cannot enter into another conference.

General

- Ⓢ The elapsed time of the call (from the originating terminal) is shown on all the Multiline Terminals with a display.
- Ⓢ When all sixteen conference circuits are in use, the Conference key lights solid red on all Multiline Terminals.
- Ⓢ Allowed conference configurations are:
 - 4 terminals - no outside party
 - 3 terminals - 1 outside party
 - 3 terminals - no outside party
 - 2 terminals - 1 outside party
 - 1 terminal - 2 outside parties
- Ⓢ Only one member of a conference can place a conference on hold at a time.
- Ⓢ When the conference is placed on hold, the Conference LED flashes on all phones in the conference.
- Ⓢ No recall is provided at the Multiline Terminal when a conference is on hold.
- Ⓢ The CO to CO db loss of conference is 6 db (3 db per CO). This value does not include the loss already occurring on each CO circuit. A telephone for conference connection incurs a 10 db loss in volume.

RELATED FEATURES LIST

Features which can use conference circuits are: Voice Over Split (V-2), Live Recording (D-6), Barge-In (B-3), Unsupervised Conference (U-4) and Add-on Conference.

Feature Number	Feature Name
A-26	Automatic Release
P-8	Privacy Release

FEATURE DESCRIPTION

The All Call Page feature allows simultaneous paging (internal and external) of all idle Multiline Terminals in a zone over their built-in speakers and over all external paging speakers. This enables a person, away from their desk but within hearing distance of a Multiline Terminal or external speaker, to respond to the paging call.

SYSTEM AVAILABILITY

Terminal Type



All Terminals.

Required Components



None.

OPERATING PROCEDURES

To originate a page on a Multiline Terminal:

1. Lift the handset, and receive internal dial tone (or press , if the user is already engaged on a call).
2. Dial Access Code   (set as default) for All Call Page.
3. Page.

To answer a page on a Multiline Terminal:

1. Go off-hook.
2. Receive internal dial tone.
3. Dial Meet-Me Access Code   (set as default); the display changes to show the originator station number.
4. Talk with All Call Page originator.

To originate a page on a Single Line Telephone:

1. Lift the handset, and receive internal dial tone or press the hookswitch if the user is already engaged in a call.
2. Dial Access Code $\textcircled{5}$ $\textcircled{9}$ (set as default) for All Call Page.
3. Page.

To answer a page on a Single Line Telephone:

1. Lift the handset or press the hookswitch if the user is already engaged in a call.
2. Receive dial tone.
3. Dial Meet-Me Access Code $\textcircled{5}$ $\textcircled{*}$ (set as default).
4. Talk with All Call Page originator.

QUICK ACCESS CODE REFERENCE

Default	Access Code Name	Alphabetic Designation
59	All Internal/External Zone Paging	N/A
5*	Internal/External Meet-Me	N/A

SERVICE CONDITIONS

Data Assignment

- Stations can be allowed or denied receiving paging through System Programming. This includes All Call Page, Internal Zone Paging, and External Zone Paging. This does not include Internal Emergency All Call Page.
- In System Programming, paging alert tone (Internal and/or External) can be allowed or denied system-wide. The default assignment is Receive Paging Alert Tone.

Restrictions

- Multiline Terminal users engaged in a handsfree call do not receive All Call Page or Internal Zone Pages.
- Multiline Terminals provided with Off-Hook Voice Announcement cannot receive All Call Page when already engaged in a call.
- Only one All Call Page or Internal Zone Page can be established at a time. Another page can be originated as soon as the first is abandoned or answered (by Meet-Me Answer).

- Simultaneous zone paging (Internal Zones A, B, and C) can be established at one time; however, All Internal Zone Paging and Internal Emergency All Call Page cannot be performed if any other internal page is in use.

General

- All Call Page can be originated or answered (by Meet-Me Answer) from internal dial tone.
- All Call Page times out using the External Paging Time Out with a default time of five minutes.
- An outside line can be conferenced with External Page to allow a conversation to be monitored.
- The default Access Code for All Call Page is 59. The default Access Code for All Call Page Meet-Me code is 5* (Internal/External Meet Me).



RELATED FEATURES LIST

Feature Number	Feature Name
E-1	Elapsed Call Timer
I-6	Internal Zone Paging (Meet Me)

GUIDE TO FEATURE PROGRAMMING

Order and Shortcut	System Data Name	Memory Block	Function	1-8-07 Attendant Page-Line Key	1-8-08 Station Page-Line Key
+BA	Access Code (1-, 2-, or 3-Digit) Assignment	1-1-46/47/48	070~079, 081		
+BTM	Internal Zone Paging Selection	4-93			
+BTT	Receiving Internal/All Call Page Selection	4-31			
+BP	Internal Paging Alert Tone Selection	1-2-25			
+BP	Internal Paging Timeout Selection	1-2-00			
+BP	External Speaker Connection Selection	1-7-02			
+BP	External Paging Alert Tone Selection	1-7-03			
+BP	External Speaker Pre-Tone/Chime Selection	1-7-08			

Doc. No. 8201 - Release 1.0
July 2003

Order and Shortcut	System Data Name	Memory Block	Function	1-8-07 Attendant Page-Line Key	1-8-08 Station Page-Line Key
 +BP	External Speaker Chime Start time Selection	1-7-09			
 +BP	External Paging Timeout Selection	1-7-06			

Alphanumeric Display

A-6

FEATURE DESCRIPTION

Each Display Multiline Terminal is equipped with a 24-character by 3-line Liquid Crystal Display (LCD). These displays provide information such as: date/time, elapsed call time on outside calls, digits Dialed, internal calling party number, Customised Message, and Speed Dial entries.

SYSTEM AVAILABILITY

Terminal Type

All Multiline Terminals with a Display.

Required Components

None.

LCD DISPLAYS

Display	Location	Definition
12:24 AM WED 10	All Stations with LCD	Clock/Calendar
FWD 100 -> []		Set Call Forward - All Calls
ALL FWD CANCLD		Cancel DND/Call Forward - All Calls System-Wide
FWD/DND CANCLD	Originator	Cancel DND/Call Forward - All Calls At Individual Stations
FWD SET []	Originator	Set Call Forward - All Calls From Forward To Extension
FWD RESET []		Reset Call Forward - All Calls From Forward To Extension
BUSY 100 --> [_]		Set Call Forward - Busy
FWD BUSY CANCLD		Cancel Call Forward - Busy
NOANS 100 -> []		Set Call Forward - No Answer
FWD NA CANCLD		Cancel Call Forward - No Answer
FWD BNA -> []		Set Call Forward Busy - No Answer
FWD BNA CNCL		Cancel Call Forward Busy - No Answer
BACK MM/DD HH:MM		Set Customised Message
MESSAGE CLEAR		Cancel Customised Message System-Wide or From Individual Station
NIGHT MODE SET		Night Mode Switch
NIGHT MODE RESET		Reset Night Mode
NT TENANT		Set Night Mode For Tenant
CALLBACK CANCLD		Cancel Callback System-Wide





Display	Location	Definition
FNC LAMP OFF		Reset FNC LED
CURRENT PASSWORD ?	Originator	Telephone Password (1)
NEW PASSWORD ?	Originator	Telephone Password (2)
ENTER PASSWORD	Originator	Set Password (CO/PBX Restriction)
RESTRICT SET	Originator	After Setting Password
CALL DENIED	Originator	Display on Station Outgoing Restricted Telephone
RESTRICT CANCLD	Originator	After Cancelling Outgoing Call Restriction
CANCEL TEL		Cancel Restriction on Another Telephone
RLY 0 ON		Relay On
RLY 0 OFF		Relay Off
ALARM AM 00 : 00		Set Alarm For A.M.
ALARM PM 00 : 00		Set Alarm For P.M.
ALL ALARM CANCLD		Cancel Alarm System-Wide
SET TIME REMINDR		Set Timed Alarm for SLT
DND SET	Originator	Set Do Not Disturb
*<- - XXXXXXXXXX	Originator	Save and Repeat Number Is Stored
ALL PAGE	Originator	Internal All Zone Paging
GROUP [A]		Group Paging
SPKR [A]	Originator	External Speaker
TRF SET CO =		Set Automatic Tandem Trunk Transfer IN/OUT Trunk
TRF CNCL CO =		Reset Automatic Tandem Trunk Transfer
TRF TO CO =		Set or Confirm Transferred Trunk of Automatic Tandem Trunk Transfer
TRNS TO N / A		Transferred Trunk Not Assigned
00 : EMPTY		No Speed Dial Number Entered
00 : 0 1 2 3 4 5 6 7 8 9		Speed Dial Number Confirmation
NO SMDR		Station Message Detail Recording Not Available
ERROR		Error Message
BUSY		Busy Message
PRINTER TROUBLE		Printer Problems
SPKR [A , B , C]	Originator	External All Paging
LINE IDLE	Originator	Trunk Queuing; CO/PBX Trunk Idle
TRUNK QUE SET	Originator	Trunk Queuing Set
LNR [#] / SPD []		Press LNR/SPD Key
TRUNK QUE CANCLD	Originator	Trunk Queue cancelled

Display	Location	Definition
RCL : 0 1 , 0 2 , 0 3 , 0 4	Originator	Hold Recall
120 < - [1 1 0] TRANSF	Destination	Ring Transfer
120 = = [1 1 0] TRANSF		Automatic Ring Transfer
OVD > []		Barge-In On CO/PBX Line (1)
OVD - > CO []		Barge-In On CO/PBX Line (2)
100 < - TIE LN —		Tie Line Answer
100 < - DID LN —		DID Answer
DATA ENTRY		Enter Data Via System Programming
STA NUMBER?		Call Pickup Direct Originate
100 __ [101]URGENT		Voice Over Split Originate/Receive
01/12147517627		Caller ID Indication
MUSIC SET/RESET		Background Music is On/Off
100		Extension number only to be displayed at idle
NAME		Extension name only to be displayed at idle
10 NAME		Extension No.2 digits with number and name display
100 NAME		Extension No.3 digits with number and name display
1000 NAME		Extension No.4 digits with number and name display

SERVICE CONDITIONS

- ⓘ French, Spanish and Japanese characters are also available for some displayed test.

GUIDE TO FEATURE PROGRAMMING

Order and Shortcut	System Data Name	Memory Block	Function	1-8-07 Attendant Page-Line Key	1-8-08 Station Page-Line Key
 +BCT	* Trunk Name/Number Assignment	3-00			
 +BTT	* Station Name Assignment	4-18			
 +BE	Speed Dial Number/Name Display Selection	1-1-33			
 +BI	Customised Message 1~10 Assignment	1-2-09~18			
 +BTM	Multilingual LCD Indication Selection	4-28			

* When the system is at default this Memory Block **must** be programmed for the feature to be used.

Ancillary Device Connection

A-7

FEATURE DESCRIPTION

The Ancillary Device Connection feature allows installation of selected peripheral (ancillary) devices such as an amplified handset, headset, Analogue telephone devices, or external speakerphone for use on any Multiline Terminal. This feature enhances operation for which the peripheral devices are designed.

A *D^{term}* Series i Terminal user can accomplish this by using the AP(R)-R() Unit (Analogue Port Adapter with Ringer) or AP(A)-R() Unit (Analogue Port Adapter without Ringer) for analogue telephone devices, or installing the AD(A)-R() Unit to connect devices such as tape recorders.

The AP(A)-R()/AP(R)-R() Unit is the interface for installing a Single Line Telephone, Modem, Credit Card Reader, Wireless Headset, Conferences unit or other compatible analogue devices.

SYSTEM AVAILABILITY

Terminal Type

D^{term} Series i Multiline Terminals, except DTR-2DT-1A.

Required Components

AD(A)-R(), AP(A)-R(), AP(R)-R()

OPERATING PROCEDURES

Vary, depending on the ancillary device connected:

SERVICE CONDITIONS







Data Assignment

- ④ Use Memory Block 1-1-02 (Hookflash Time Selection) to specify the loop open time for a hookflash signal sent to the CO/PBX when the recall key on a Multiline Terminal is pressed.
- ④ Use Memory Block 1-3-02 (SLT Hookflash Signal Selection) to specify whether a line is held internally or, if behind a PBX, a hookflash (HF) signal is sent to the line when a Single Line Telephone user performs a hookflash.
- ④ Use Memory Block 4-24 (SLT Hookflash Assignment) to either hold or disconnect the trunk for the Single Line Telephone (SLT) hooking operation.
- ④ Use Memory Block 4-39 (APR Ring Mode Assignment) to assign the AP(R)-R() Unit for NON (No Ring), STA (default: ring Station Number only) or ALL.
- ④ Use Memory Block 4-59 (APR Hookflash Selection) to allow or deny hookflash on an AP(R)-R() unit.

General

- ④ The optional devices fit underneath the appropriate terminal.
- ④ An AP(A)-R() or AP(R)-R() Unit with hookflash enabled follows the same operating procedures as a Single Line Terminal connected to an SLI()-U() ETU.

GUIDE TO FEATURE PROGRAMMING

Order and Shortcut	System Data Name	Memory Block	Function	1-8-07 Attendant Page-Line Key	1-8-08 Station Page-Line Key
 +BTM	APR Ring Mode Assignment	4-39			
 +AU	APR/APA Hookflash Selection	4-59			
 +BTI	DTMF/DP SLT Type Selection	4-95			
 +BTI	SLT Hookflash Signal Selection	1-3-02			
 +BCM	Hookflash Time Selection	1-1-02			
 +BTI	SLT Hookflash Assignment	4-24			

FEATURE DESCRIPTION

The Answer Hold feature enables a Multiline Terminal user to press the flashing Answer key to answer an incoming ringing call on a CO line key. If the Multiline Terminal user is already engaged in a call, the first call is automatically placed on Non-Exclusive Hold when the second call is answered. Answer Hold is particularly useful at Attendant Positions or other central answering positions. Using the Answer key speeds call handling, while Answer Hold prevents accidental call dropping.

SYSTEM AVAILABILITY

Terminal Type





All Multiline Terminals.

Required Components

None.





OPERATING PROCEDURES

To answer calls on a different line key with a call in progress:

1. Receive CO/PBX incoming ring. The  LED flashes.
2. Press , and answer the new call ( LED goes off). The original call is put on Hold.
 - a. If the original call was on a Call Appearance Key, the call is placed on Non-Exclusive Hold on the Call Appearance Key.
 - b. If the call was on a line key, the call is placed on Non-Exclusive Hold on the line key.
3. Talk with the CO/PBX incoming caller.
4. If additional calls are received, press  to place the current call on Hold and connect to the next call. (Refer to a. and b. above.)

SERVICE CONDITIONS









Restrictions

-  The Answer Hold feature does not function for incoming internal calls.
-  CO/PBX incoming calls not assigned to ring or assigned to other tenants do not activate the Answer Hold feature.
-  DID/Tie line and DIT/ANA calls do not activate the Answer Hold feature.
-  If all the Call Appearance keys are in use, the next call cannot be answered.

General

- ☎ CO/PBX ringing transfer/camp-on calls may be answered.
- ☎ If multiple incoming calls activate the Answer key LED, the LED continues to flash until all the calls are answered.

GUIDE TO FEATURE PROGRAMMING

Order and Shortcut	System Data Name	Memory Block	Function	1-8-07 Attendant Page-Line Key	1-8-08 Station Page-Line Key
 +BTT	* CO/PBX Ring Assignment (Day Mode)	4-01			
 +BTT	* CO/PBX Ring Assignment (Night Mode)	4-02			
 +BTM	Line Key Selection for Telephone Mode	4-12			
 +BTM	Extension Line Key Ring Assignment (Day Mode)	4-37			
 +BTM	Extension Line Key Ring Assignment (Night Mode)	4-38			
 +BTP	Doorphone Chime Assignment (Day Mode)	4-03			
 +BTP	Doorphone Chime Assignment (Night Mode)	4-04			
 +BTS	* Off-Hook Ringing Selection	4-51			
 +BM	Hold Recall Time Selection (Non-Exclusive Hold)	1-1-03			

* When the system is at default this Memory Block **must** be programmed for the feature to be used.

FEATURE DESCRIPTION

Multiline Terminals are equipped with an Answer key and associated LED. The Answer key LED flashes when the Multiline Terminal user receives an incoming CO/PBX, Tie/DID transferred, and CO/PBX transferred call ringing/or not ringing in the same tenant group. When multiple calls are received, the Answer key is used to pick up calls. The Answer key continues flashing until the last unanswered call is answered. Press the Answer key during a call to hold the current call and allow the next call to be answered.

SYSTEM AVAILABILITY

Terminal Type





All Multiline Terminals.

Required Components

None.

OPERATING PROCEDURES

To answer calls using the Answer key:

1. Receive CO/PBX incoming ring or flashing MW lamp without ringing.  LED flashes.
2. Press . The  LED goes out.
3. Talk with the CO/PBX incoming calling party.
4. If additional CO incoming calls are received, the  LED flashes again. Press  to place the current call on Non-Exclusive Hold and connect the Multiline Terminal user to the next call.
 - a. If the original call was on a Call Appearance Key, the call is placed on Non-Exclusive Hold on the Call Appearance Key.
 - b. If the call was on a line key, the call is placed on Non-Exclusive Hold on the line key.

SERVICE CONDITIONS













Restrictions

- ⓘ Internal calls, internal transfer/camp-on calls, Secondary Incoming Extension, Automated Attendant, and Tie/DID calls do not activate the Answer key LED.

General

- ④ The Answer key LED functions for incoming CO/PBX calls, CO/PBX transfer/camp-on calls, and transferred/camped-on Tie/DID calls.
- ④ Incoming CO/PBX ringing calls to other tenants, with the CO/PBX line appearance and with or without ring assignment, activate the Answer key LED.
- ④ Incoming calls answered by the Answer key are handled on a *first in-first out* basis.

GUIDE TO FEATURE PROGRAMMING

Order and Shortcut	System Data Name	Memory Block	Function	1-8-07 Attendant Page-Line Key	1-8-08 Station Page-Line Key
 +BTT	* CO/PBX Ring Assignment (Day Mode)	4-01			
 +BTT	* CO/PBX Ring Assignment (Night Mode)	4-02			
 +BTM	Line Key Selection for Telephone Mode	4-12			
 +BTM	Extension Line Key Ring Assignment (Day Mode)	4-37			
 +BTM	Extension Line Key Ring Assignment (Night Mode)	4-38			
 +BTP	Doorphone Chime Assignment (Day Mode)	4-03			
 +BTP	Doorphone Chime Assignment (Night Mode)	4-04			
 +BCT	DIT Assignment	3-42			
 +BCT	ANA Assignment	3-43			
 +BTS	* Off-Hook Ringing Selection	4-51			
 +BTT	CO/PBX Answer Key Operation Without Ringing Assignment (Day Mode)	4-52			
 +BTT	CO/PBX Answer Key Operation Without Ringing Assignment (Night Mode)	4-53			

* When the system is at default this Memory Block **must** be programmed for the feature to be used.

Assigned Night Answer (ANA)

A-10

FEATURE DESCRIPTION

The Assigned Night Answer (ANA) feature is a Direct Inward Termination programmed to ring directly at a selected station when the system or tenant is in the Night Mode. This assignment operates independently from the DIT (Day Mode) ringing assignment.

SYSTEM AVAILABILITY

Terminal Type

All terminals.

Required Components

None.

OPERATING PROCEDURES

Normal incoming call handling procedures apply.

SERVICE CONDITIONS

Data Assignment

- ☎ CO/PBX lines can be assigned to ring a station number, a hunt group master number, or an ACD/UCD Pilot number.
- ☎ Multiple CO/PBX lines can be assigned to ring at the same station, hunt group master number, or ACD/UCD Pilot number.
- ☎ Incoming ANA calls follow the station Call Forward setting.

Restrictions

- ☎ When a CO/PBX line is assigned for ANA, the Night Mode CO/PBX ring assignment is disabled.

General











- ☎ ANA incoming ringing is assigned for Distinctive Ring or Synchronous Ring system-wide.
- ☎ When a busy station, programmed for ANA, receives an incoming ANA call, the system provides Camp-On tone for the busy station. The calling party receives ringback tone until the call is answered.
- ☎ A Call Pickup for the same tenant, Access Code 68 (set at default), can be used to answer ANA calls.
- ☎ ANA calls do not activate External Tone Ringer or Night Chime.



- ④ ANA calls can be assigned to ring on voice mail ports. A hunt group can be assigned by using the internal master hunt number assignments.
- ④ When a station, programmed for ANA, receives an incoming ANA call, internal ring tone is heard at all stations where a secondary incoming extension appears and is assigned to ring.
- ④ Incoming ANA calls cannot be answered directly at the CO line key appearance. The CO line key indicates Other Use (red LED).
- ④ While receiving an incoming ANA call, an internal call cannot be made.
- ④ ANA or DIT ringing can be delayed for 0, 5, 10, 20, 30, 40, 50, 60 seconds.

RELATED FEATURES LIST

Feature Number	Feature Name
D-10	Direct Inward Termination (DIT)

GUIDE TO FEATURE PROGRAMMING

Order and Shortcut	System Data Name	Memory Block	Function	1-8-07 Attendant Page-Line Key	1-8-08 Station Page-Line Key
 +BCT	DIT Assignment	3-42			
 +BCT	* ANA Assignment	3-43			
 +BCT	DIT/ANA Delay Answer Time Selection	3-61			
 +BCT	DIT Tenant Assignment	3-62			
 +BCT	DIT Weekend Mode Selection	3-63			
 +BCT	DIT Night Mode Delay Answer Selection	3-64			
 +BN	Trunk to Tenant Assignment	2-01			
 +BTT	Telephone to Tenant Assignment	4-09			
 +BN	Line Key Selection for Tenant Mode	2-06			
 +BTM	Line Key Selection for Telephone Mode	4-12			

Order and Shortcut	System Data Name	Memory Block	Function	1-8-07 Attendant Page-Line Key	1-8-08 Station Page-Line Key
 +BTT	Call Forward - Busy Immediately/Delay Selection	4-42			
 +BM	Call Forward - No Answer Time Selection	1-2-22			

* When the system is at default this Memory Block **must** be programmed for the feature to be used.

THIS PAGE INTENTIONALLY LEFT BLANK

Attendant Add-On Console

A-11

FEATURE DESCRIPTION

The Attendant Add-On Console functions in conjunction with a Multiline Terminal programmed as an Attendant. This console provides access to a maximum of 48 stations and/or outside lines. The Busy Lamp Field status is shown as a red LED for each station or trunk. Trunks can include CO/PBX, ISDN, DID and E&M Tie Lines. In addition, the Attendant Add-On Console also has 12 function keys that can be used for attendant messaging, paging access, or other undefined functions.

SYSTEM AVAILABILITY

Terminal Type

Any terminal programmed as an Attendant Position.

Required Components

DCR-60-1A() or DCU-60-1A() Console.

OPERATING PROCEDURES

To transfer a call:

1. Attendant answers an incoming CO/PBX call.
2. Press the DSS/BLF key for the desired station. The calling party is put on Non-Exclusive Hold.
3. When the called party answers the Attendant call, the Attendant announces the call and then presses **Transfer** on the Attendant Add-On Console.
4. Go on-hook.

- OR -

Attendant answers an incoming CO/PBX call.

5. Press the Attendant Add-On Console key for the desired station. The calling party is put on Non-Exclusive Hold.
6. Press **Transfer** on the Add-On Console.
7. Go on-hook.

To call a station:

1. Lift the handset and receive internal dial tone.
2. Press the DSS/BLF key for the desired station. Hear ringback tone or voice announce the station.
3. Called party answers.

To set/cancel Message Waiting or Station Outgoing Lockout (Outgoing Restrict) to station:

1. Press the Message Wait or Station Lockout key.
2. Press the DSS/BLF key for the desired station.

To make an outgoing call using the Attendant Add-On Console from the Attendant Position:

1. Go off-hook with the handset or just press a CO line key on the Attendant Add-On Console.
2. Dial the desired number.

To answer an incoming call using the Attendant Add-On Console from the Attendant Position

Press the incoming CO line key or flashing  if ringing is assigned.

**SERVICE
CONDITIONS****Data Assignment**

- ④ Additional attendant-type features can be allowed or denied in the Class of Service (Attendant) Feature Selection.

Restrictions

- ④ A maximum of four DCR-60-1A() or DCU-60-1A() Consoles can be installed per system.
- ④ A maximum of four Attendant Add-On Consoles can be connected to one station.

General

- ④ The 48 DSS keys and 12 function keys on Attendant Add-On Consoles are flexible and can be changed.
- ④ Both DSS/BLF for stations and CO lines can appear on the same DCR-60-1A() or DCU-60-1A() Consoles.

- ⓘ Depending on System Programming (DSS Call Voice/Tone Signal Selection), the called party rings or receives a voice announcement when an Attendant makes a call using the Attendant Add-On Console.
- ⓘ When the Attendant transfers a call, the transferred outside line remains on Non-Exclusive Hold until the call is answered.
- ⓘ Each installed Attendant Add-On Console reduces the maximum number of stations by one.
- ⓘ The keys are assigned at default as follows:

Keys		
01~48	ICM Call	Stations 100-147 (depending on system configuration)
49	Night Mode	
50~53	Direct Paging Access	Internal Zone and All Zone Page
54	Vacant	
55	Message	
56~59	External All Zone Paging	External Zone and All Zone Page
60	Transfer	

- ⓘ Busy Lamp Field indications show if Multiline Terminals, outside lines, or zone paging is in use.
- ⓘ Busy Lamp Field status indications at the Attendant Add-On Console are:

LED Indications	Busy Lamp Field Status
Off	Station Idle
Green	Not Used
Red	Busy
Flashing	DND, Call Forward - All Calls, Break Mode (by ACD Agent)
Winking	Function Programming Mode

LED Indications	Outside Line Status
Off	Outside Line Idle
Green	In Use (by Attendant station)
Red	Busy
Winking	Call On Hold
Flashing	Incoming Call

- Message Waiting/Station Outgoing Lockout status indications at the Attendant Add-On Console are:















LED Indications	Station Status
Off	No Message/Lockout Not Set
Green	Message Waiting/Lockout Set

- The Attendant, with an Attendant Add-On Console, can set a message to a Single Line Telephone if the Single Line Telephone is equipped with a Message Waiting LED and connected to a SLI(8)-U() ETU.
- When the Message Waiting indication is set, the Large LED flashes green on Multiline Terminals and continues to flash until the message is cancelled by an Attendant.
- Attendant Add-On Consoles can be assigned to any Multiline Terminal programmed as an Attendant Position.
- When the entire system is switched into the Night Mode, the Night Transfer (NT) key LED on the Attendant Add-On Console lights red.
- An Attendant Add-On Console cannot have a Message Wait key and a Station Lockout key assigned at the same time.
- If multiple CO calls are ringing at an Attendant Station or Attendant Add-On Console, the calls are answered in *first in-first out* order.

RELATED FEATURES LIST

Feature Number	Feature Name
A-13	Attendant Positions
A-14	Attendant Station Outgoing Lockout
B-2	Background Music Over External Speakers
M-1	Message Waiting

GUIDE TO FEATURE PROGRAMMING

Order and Shortcut	System Data Name	Memory Block	Function	1-8-07 Attendant Page-Line Key	1-8-08 Station Page-Line Key
 +BS	* Telephone Type Assignment	7-2			
 +BTD	* Attendant Add-On Console to Telephone Port Assignment	1-6-01			
 +BTD	Attendant Add-On Console Key Selection	1-6-05			
 +BTD	DSS Call Voice/Tone Signal Selection	1-6-03			
 +BTS	Class of Service (Attendant) Feature Selection 1	1-8-07		All	
 +BTS	Class of Service (Station) Feature Selection 2	1-8-08			4-2
 +BTT	Station To Class Of Service Feature Assignment	4-17			
 +BTT	CO/PBX Ring Assignment (Day Mode)	4-01			
 +BTT	CO/PBX Ring Assignment (Night Mode)	4-02			
 +BTM	Line Key Selection for Telephone Mode	4-12			
 +BTM	Extension Line Key Ring Assignment (Day Mode)	4-37			
 +BTM	Extension Line Key Ring Assignment (Night Mode)	4-38			
 +BTT	Prime Line/Hot Line Assignment	4-23			
 +BTD	Attendant Transfer Selection During Live Record	1-6-08			

* When the system is at default this Memory Block **must** be programmed for the feature to be used.

THIS PAGE INTENTIONALLY LEFT BLANK

Attendant Camp-On

A-12

FEATURE DESCRIPTION

The Attendant Camp-On feature, used at an Attendant Position with an Attendant Add-On Console, allows a call to be transferred to a busy station. Press the Transfer key on the Attendant Add-On Console to send the Camp-On tone to the busy station. A camped on call that is not answered in a preprogrammed time recalls to the Attendant Position.

SYSTEM AVAILABILITY

Terminal Type

Any terminal with Display programmed as an Attendant Position.

Required Components



DCR-60-1A() or DCU-60-1A() Console.

OPERATING PROCEDURES

To use this feature at an Attendant Position with a CO/PBX Call in progress:

1. Press the DSS/BLF key on the Attendant Add-On Console or the Attendant Position for the desired station.
2. Receive call waiting tone.
3. Press  on the Attendant Add-On Console or on the Attendant Position. Camp-On is set.
4. Go on hook.
5. After time-out, if the Camp-On is not answered, a recall tone is received at the Attendant Position, and the LED on the assigned CO/PBX line key or Call Appearance Key returns to flashing green.
6. Press the CO/PBX line key with the flashing green LED to return to the call.

To answer a Camp-On Call from a Multiline Terminal:

1. The user is engaged in a call.
2. Receive a camp-on tone. The  flashes red, the Large LED flashes green, and CO/PBX line flashes green, if assigned.
3. Press  and talk with the CO/PBX incoming caller. The previous call is put on hold.

To answer a Camp-On Call from a Single Line Telephone:

1. The user is engaged in a call.
2. Receive a camp-on tone.
3. Hang up or put the call on System Call Park.
4. Go off-hook, and talk with the CO/PBX incoming caller.

SERVICE CONDITIONS

Data Assignment

- ☎ This feature is allowed only if the system is programmed for Ring Transfer.
- ☎ The Attendant Camp-On Recall Timer can be set for 30 seconds, 1, 1.5, 2, 3, 5, 8, or 10 minutes (default:1 minute).
- ☎ In Class of Service (station) assignments, stations can be assigned not to receive an Attendant Camp-On tone.

Restrictions

- ☎ Camp-On is not allowed to stations that have received Tone Override.





General

- ☎ The camp-on tone is heard over the handset or from the speaker if the Multiline Terminal is in the handsfree mode.
- ☎ Any number of outside calls can be camped on to a station. When the station goes idle, the Camp-On calls are answered in order from the lowest numbered lines to the highest numbered lines.
- ☎ Two types of Camp-On are provided by the system
 - Attendant Camp-On
 - Station Camp-On.

RELATED FEATURES LIST

Feature Number	Feature Name
C-17	Class of Service
D-14	Do Not Disturb (DND)
S-12	Speed Dial – System

GUIDE TO FEATURE PROGRAMMING

Order and Shortcut	System Data Name	Memory Block	Function	1-8-07 Attendant Page-Line Key	1-8-08 Station Page-Line Key
 +BTS	System Transfer/Camp-On Selection	1-1-11			
 +BTS	Class of Service (Station) Feature Selection 2	1-8-08			4-2, 3-3
 +BTT	Station To Class Of Service Feature Assignment	4-17			
 +BTT	SLT Data Line Security Assignment	4-90			
 +BM	Attendant Add-On Console Transfer/Camp-On Recall Time Selection	1-1-64			

THIS PAGE INTENTIONALLY LEFT BLANK

Attendant Positions

A-13

FEATURE DESCRIPTION

Any number of stations can be designated an Attendant Position. These stations have access to distinct Attendant-type features; up to four attendants can support Attendant Add-On Consoles. Attendant features such as setting Night Mode and System Speed Dial memory programming apply.

SYSTEM AVAILABILITY

Terminal Type

Any terminal with Display programmed as an Attendant Position.

Required Components

None.

OPERATING PROCEDURES

Provided under specific Attendant feature descriptions:

SERVICE CONDITIONS

Data Assignment

- ④ The first two station ports, 01 and 02, are assigned as Attendant Positions by Resident System Programming.
- ④ Attendant features can be assigned to any station via station Class of Service.







Restrictions

- ④ A maximum of four Attendant Add-On Consoles can be assigned to one Attendant Position.
- ④ A maximum of four Attendant Add-On Consoles can be assigned in the system.
- ④ Up to four Attendant positions can have an Attendant Add-on Console.

RELATED FEATURES LIST

Feature Number	Feature Name
A-18	Automated Attendant
C-1	Call Alert Notification
C-7	Caller ID - Outgoing
D-14	Do Not Disturb (DND)
N-4	Night Transfer Night Transfer
S-8	SLT Timed Alarm
S-12	Speed Dial – System
S-18	Station Relocation

GUIDE TO RELATED PROGRAMMING

Order and Shortcut	System Data Name	Memory Block	Function	1-8-07 Attendant Page-Line Key	1-8-08 Station Page-Line Key
 +BS	Telephone Type Assignment	7-2			
 +BTD	Attendant Add-On Console to Telephone Port Assignment	1-6-01			
 +BTD	Attendant Add-On Console Key Selection	1-6-05			
 +BTS	Class of Service (Attendant) Feature Selection 1	1-8-07		1-1~1-3, 1-7	
 +BTS	Class of Service (Station) Feature Selection 2	1-8-08			2-6, 4-2
 +BTT	Station to Class Of Service Feature Assignment	4-17			

Attendant Station Outgoing Lockout

A-14

FEATURE DESCRIPTION

The Attendant Station Outgoing Lockout feature allows an Attendant Position with an Attendant Add-On Console to set a predetermined Code Restriction Class Assignment to any station that is assigned on the Attendant Add-On Console. This allows an Attendant to set/reset restrictions to disallow outgoing calls.

SYSTEM AVAILABILITY

Terminal Type

Any Display terminal programmed as an Attendant Position.

Required Components

DCR-60-1A() or DCU-60-1A() Console.

OPERATING PROCEDURES

To set the Attendant Station Outgoing Lockout from the Attendant Position using the Attendant Add-On Console:

1. Press the key programmed as Lockout key on the Attendant Add-On Console.
2. Press the DSS key on the Attendant Add-On Console that is associated with the station where Attendant Station Outgoing Lockout is desired.
3. The green LED lights next to the DSS key to indicate lockout is set.

To cancel the Attendant Station Outgoing Lockout from the Attendant Position using the Attendant Add-On Console:

1. Press the key programmed as Lockout key on the Attendant Add-On Console.
2. Press the DSS key on the Attendant Add-On Console that is associated with the station where Attendant Station Outgoing Lockout is to be cancelled.
3. The green LED next to the DSS key turns off to indicate the lockout is cancelled.

SERVICE CONDITIONS

Data Assignment

- ④ At default, when a station with Attendant Station Outgoing Lockout is set, the station is outgoing restricted. This can be changed (system-wide) to a different Code Restriction Class in System Programming.
- ④ When up to four Attendant Add-On Consoles are installed, the Attendant Station Outgoing Lockout is displayed only on the Attendant Add-On Console from where the Lockout was set.

Restrictions

- ④ An Attendant Add-On Console, with an Attendant Station Outgoing Lockout key assigned on it, cannot be used to set the Message Waiting feature from an Attendant.





General

- ④ All Attendant Add-On Consoles can be used to set Attendant Station Outgoing Lockout.
- ④ Attendant Station Outgoing Lockout is retained by the memory backup battery.
- ④ No indication is provided at a terminal when Attendant Station Outgoing Lockout is set.
- ④ To confirm that Attendant Station Outgoing Lockout is set at an Attendant Add-On Console, ensure that the green LED associated with the station is lit. Lockout remains set until cancelled at the Attendant Add-On Console where it was set.
- ④ The station with Attendant Station Outgoing Lockout set cannot manually cancel the lockout.

RELATED FEATURES LIST

Feature Number	Feature Name
M-1	Message Waiting
S-17	Station Outgoing Lockout

GUIDE TO FEATURE PROGRAMMING

Order and Shortcut	System Data Name	Memory Block	Function	1-8-07 Attendant Page-Line Key	1-8-08 Station Page-Line Key
 +BTD	* Attendant Add-On Console Key Selection	1-6-05			
 +AC	Code Restriction Class Assignment When Lockout is Set	1-1-70			
 +AC	Code Restriction Class Assignment (Day Mode)	4-07			
 +AC	Code Restriction Class Assignment (Night Mode)	4-08			

* When the system is at default this Memory Block **must** be programmed for the feature to be used.

THIS PAGE INTENTIONALLY LEFT BLANK

Attendant Transfer

A-15

FEATURE DESCRIPTION

The Attendant Transfer feature permits efficient call transfers in the system using an Attendant Multiline Terminal equipped with one to four Attendant Add-On Console(s). Transferred calls can be voice announced, ring transferred, or camped on (if the station is busy). All unanswered transferred calls return to the Attendant with distinct audible and visual indications, after a programmed time interval.

SYSTEM AVAILABILITY

Terminal Type

Any terminal with Display programmed as an Attendant Position.

Required Components

DCR-60-1A Console or DCU-60-1A Console.

OPERATING PROCEDURES

To use this feature at the Attendant Position with a CO/PBX call in progress:

1. Press the DSS key on the Attendant Add-On Console or the Attendant Position for the desired station.
2. Receive ringback tone or voice announcement.
3. Press  on the Attendant Add-On Console or on the Attendant Position. The call is transferred.
4. Hang up.
5. After time-out, if the transferred call is not answered, a recall tone is received at the Attendant Position; and the LED on the assigned CO/PBX line key or Call Appearance Key returns to flashing green.
6. Press the CO/PBX line key with the flashing green LED to return to the call.

SERVICE CONDITIONS

Data Assignment

- ☎ The Attendant Transfer/Camp-On recall time-out is programmable (default: 60 seconds).
- ☎ CO Transfer Ring Pattern and Ring Tone can be assigned in System Programming.









General

- ④ When a Transfer/Camp-On is denied, the call remains on hold at the Attendant Position Multiline Terminal.
- ④ The outside line key LED flashes green on the station receiving the Transfer/Camp-On, if the line appears on that station. The Large LED also flashes green and the LED or the ANS key flashes red.
- ④ An Attendant trying to Transfer/Camp-On a call to a station may be denied, if the Multiline Terminal is busy and receiving Tone Override.

RELATED FEATURES LIST

Feature Number	Feature Name
A-11	Attendant Add-On Console
A-12	Attendant Camp-On
A-26	Automatic Release

GUIDE TO FEATURE PROGRAMMING

Order and Shortcut	System Data Name	Memory Block	Function	1-8-07 Attendant Page-Line Key	1-8-08 Station Page-Line Key
 +BTS	* System Transfer/Camp-On Selection	1-1-11			
 +BCS	CO Transfer Ring Pattern Selection	1-1-13			
 +BCS	CO Transfer Ring Tone Selection	1-1-14			
 +AU	Class of Service (Station) Feature Selection 2	1-8-08			4-2
 +BTD	Attendant Add-On Console Key Selection	1-6-05			
 +BM	Attendant Add-On Console Transfer/Camp-On Recall Time Selection	1-1-64			
 +AU	Automated Attendant Delay Announcement Hold Tone Selection	1-4-17			
 +BTT	MOH or Ring Back Tone Selection	4-66			

* When the system is at default this Memory Block **must** be programmed for the feature to be used.

Authorisation Code

A-16

FEATURE DESCRIPTION

Authorisation Code permits a station to dial outside numbers that would otherwise be restricted. When an access code plus Authorisation Code is dialled, the station code restriction class temporarily changes to allow calls when permitted by a new code restriction class.

The Authorisation Code can be verified or unverified based on class of service and is assigned in the Forced/Verified Account Code table (these share the same table).

The Authorisation/Account Code is part of the Station Message Detail Recording (SMDR) call record.

SYSTEM AVAILABILITY

Terminal Type

All stations.

Required Components

None.

OPERATING PROCEDURES



To enter Forced Account Code/Authorisation Code from any Station:

1. Lift the handset or press  .
2. Dial Forced Account Code/Authorisation Code Access Code _____ (not set at default).
3. Dial the Account Code.
4. Dial the trunk access code and the outside number.

To program Forced Account Code/Authorisation Code from Attendant position:

1. Lift the Handset or press  .
2. Dial Forced Account Code/Authorisation Code Programming Access Code _____ (not set at default).
3. Dial the Forced Account Code/Authorisation Code Number (001~500).
4. Dial the Account Code (default: 10 digits).

SERVICE CONDITIONS

5. Press  to enter the information. The next Account Number is displayed. Repeat steps 4~5 until all desired Account Codes are entered.
6. Press  to stop entering Forced Account Codes/Authorisation Codes.

- ④ Verified or Unverified for the Forced Account Code/Authorisation Code features.
- ④ Memory Block 1-8-08 (Class of Service (Station) Feature Selection 2), Page 6, LK 3 is used to activate assign Verified or Unverified for the Forced Account Code/Authorisation Code features.
- ④ When a call is made without using an authorisation code, memory blocks 4-64 and 4-65 are used to assign the code restriction class.
- ④ When a call is made using an authorisation code, the code restriction class is temporarily changed and Memory Blocks 4-07 and 4-08 are used to assign the code restriction class.
- ④ After placing a call using an authorisation code, if the Recall or Drop keys are used, the temporary code restriction class remains with the setting assigned in Memory Blocks 4-07 and 4-08 allowing the user to dial another non-restricted number.
- ④ After placing a call using an authorisation code, when the station goes idle (On-hook), the code restriction class is reset to its previous setting assigned in Memory Blocks 4-64 and 4-65.
- ④ A total of 500 Forced Account Codes/Authorisation Codes can be entered system-wide.
- ④ Forced Account Codes/Authorisation Codes and Account Code entries Codes are printed on the SMDR report, if both are used.
- ④ **A** is placed in front of the Forced Account Codes/Authorisation Codes on the SMDR reports to distinguish them from other Account Code entries.
- ④ When the Interdigit time (default is 10 seconds) expires during the user input of a Forced Account Codes/Authorisation Code, Busy Tone is generated.
- ④ PBR Time values apply when a Single line Telephone is used to enter a Forced Account Code/Authorisation Code.
- ④ Forced Account Codes/Authorisation Codes can be uploaded, downloaded, or modified using PC-based System Programming.

Restrictions













- ④ A Forced Account Code/Authorisation Code has a maximum of 13 digits.
- ④ The Authorisation Code feature is only provided from intercom dial tone. Direct access to trunks is bypassed by pressing CO Line Keys.









- ⓘ Existing restrictions (permitted by the temporary change to code restriction class) and Least Cost Routing (LCR) assignments are applied after Forced Account Codes/Authorisation Codes are entered.
- ⓘ Verified and Unverified Forced Account Code/Authorisation Code cannot be used in the same Class of Service.

RELATED FEATURES LIST

Feature Number	Feature Name
A-2	Account Code - Forced/Unverified
A-3	Account Code - Forced/Verified
C-19	Code Restriction
S-15	Station Message Detail Recording (SMDR)

GUIDE TO FEATURE PROGRAMMING

Order and Shortcut	System Data Name	Memory Block	Function	1-8-07 Attendant Page-Line Key	1-8-08 Station Page-Line Key
 +BA	* Access Code (1-, 2-, or 3-Digit) Assignment	1-1-46/47/48	146, 147		
 +BTS	Class of Service (Attendant) Feature Selection 1	1-8-07		2-8	
 +BTS	* Class of Service (Station) Feature Selection 2	1-8-08			5-1, 6-3
 +BTT	* Station to Class of Service Feature Assignment	4-17			
 +BTT	Code Restriction Class Assignment (Day Mode)	4-07			
 +BTT	Code Restriction Class Assignment (Night Mode)	4-08			
 +BTT	* Code Restriction Class (without Authorisation Code) Day Mode Assignment	4-64			
 +BTT	* Code Restriction Class (without Authorisation Code) Night Mode Assignment	4-65			
 +BF	Forced Account Code Length Assignment	1-8-27			
 +BS	Card Interface Slot Assignment	7-1			
 +BA	MIF (SMDR) Assignment	7-3-02			
 +BS	MIF (LCR) Assignment	7-3-01			

Order and Shortcut	System Data Name	Memory Block	Function	1-8-07 Attendant Page-Line Key	1-8-08 Station Page-Line Key
 +AS	Printer Connected Selection	1-5-13			
 +AS	Printer Line Feed Control Selection	1-5-14			
 +AS	SMDR Incoming/Outgoing Print Selection	1-5-26			
 +AS	SMDR Valid Call Time Assignment	1-5-25			
 +AS	SMDR Print Format	1-5-02			
 +AS	SMDR Telephone Print Selection	4-56			
 +CSS	COM Port Baud Rate Setting Assignment	1-8-35			
 +BM	Start Time Selection	1-1-05			

* When the system is at default this Memory Block **must** be programmed for the feature to be used.

Automatic Answer with Delay Message

A-17

FEATURE DESCRIPTION

The Automatic Answer with Delay Message feature answers incoming CO/PBX calls and plays a specified message to the outside caller while still ringing designated stations. Up to two messages can be played to the outside caller. The message(s) played are the same as the Automated Attendant message(s).

SYSTEM AVAILABILITY

Terminal Type

Not applicable.

Required Components

VRS(4)-U() ETU

OPERATING PROCEDURES

To record an Automated Attendant Message:

1. Go off-hook.
2. Dial the VRS Voice Message Record/Verify/Erase Access Code (e.g. $\textcircled{5}$ $\textcircled{0}$).
3. Dial operation:
 - $\textcircled{1}$ = Recording
 - $\textcircled{2}$ = Confirmation
 - $\textcircled{3}$ = Erasing
4. Dial operation:
 - $\textcircled{1}$ = Automated Attendant
5. Enter Automated Attendant Message ($\textcircled{1}$ $\textcircled{8}$).
6. Enter Mode:
 - $\textcircled{1}$ = Day Mode
 - $\textcircled{2}$ = Night Mode
7. Record Message.
8. Go on-hook.

To set the Automated Attendant/Delay Message Mode from the Attendant Position:

1. Press **Feature**.
2. Dial **8** **1**.
3. Dial the incoming trunk number (**0** **0** ~ **6** **4**). [**0** **0** = All CO/PBX lines].

Note: Dialling 00 sets or cancels the Automated Attendant mode for all trunks when the trunks are idle. If a trunk is busy when 00 is dialled, it is not set. To set the Automated Attendant to a busy trunk, dial the individual trunk number.

4. Press **Feature**.

To cancel the Automated Attendant/Delay Message Mode from the Attendant Position:

1. Press **Feature**.
2. Dial **8** **2**.
3. Dial the incoming trunk number (**0** **0** ~ **6** **4**). [**0** **0** = All CO/PBX lines].

Note: Dialling 00 sets or cancels the Automated Attendant mode for all trunks when the trunks are idle. If a trunk is busy when 00 is dialled, it is not set. To set the Automated Attendant to a busy trunk, dial the individual trunk number.

4. Press **Feature**.

To answer by One Level:

1. Receive an incoming CO/PBX call.
2. The Automatic Answer with Delay Message answers the call and sends a greeting.
3. The outside party hears ringback tone or MOH (System Programmable).

To answer by Two Levels:

1. Receive an incoming CO/PBX call.
2. The Automatic Answer with Delay Message answers the call and sends a greeting.
3. The outside party hears ringback tone or MOH (System Programmable).
4. After the time expires, a second message is played.
5. The outside party hears ringback tone or MOH until the call is answered.

SERVICE CONDITIONS

Data Assignment

- ④ A maximum of eight VRS(4)-U() ETU channels, four channels per VRS(4)-U() ETU, can be used for Automated Attendant.
- ④ Each channel has 240 recording seconds that can be subdivided into 2, 4, 8 or 16 equal recording times.
- ④ A maximum of eight Automated Attendants can be assigned.
- ④ Automated Attendant can be assigned per CO/PBX line. Attendant Positions can set or cancel the Automated Attendant per trunk.
- ④ The Day/Night Weekend mode greeting messages can be assigned to each Automated Attendant position. The number of times a greeting message is repeated can be assigned in System Programming.
- ④ The answering time (duration after the incoming CO/PBX call rings) is programmable. This time affects the Day/Night/Weekend mode settings per Automated Attendant.
- ④ The station can be used for recording, confirming, or deleting an Automated Attendant message if it is allowed by Station Class of Service assignment in System Programming.

Restrictions

- ④ Tie/DID lines are not supported by the Automatic Answer with Delay Message feature.
- ④ DTMF digits cannot be dialled by the outside caller while in the Automatic Answer with Delay Message mode.
- ④ CPU()-U() ETU Unit PBR circuits are not used for this feature.
- ④ Automatic Answer with Delay Message or Automated Attendant is assigned per trunk.
- ④ Automatic Trunk-to-Trunk Transfer and the Automated Attendant features cannot be set for the same trunk at the same time.









General











- ④ The Automatic Answer with Delay Message features uses the Automated Attendant Message to play to the outside caller.
- ④ DIT/ANA assigned to the same trunk has higher priority.
- ④ Automated Attendant and system Access Codes can be assigned individually.
- ④ Automated Attendant assignment is assigned to tenants and follows the tenants Day/Night/Weekend mode switching.
- ④ If Automated Attendant answer is assigned for a trunk and a VRS(4)-U() ETU is not installed, a second dial tone is provided for incoming callers.

RELATED FEATURES LIST

Feature Number	Feature Name
D-9	Direct Inward System Access (DISA)

GUIDE TO FEATURE PROGRAMMING

Order and Shortcut	System Data Name	Memory Block	Function	1-8-07 Attendant Page-Line Key	1-8-08 Station Page-Line Key
 +BS	Card Interface Slot Assignment	7-1			
 +BTI	* SLT or Automated Attendant/DISA to CPU PBR Selection	1-8-01			
 +AR	VRS Message Recording Time Selection	1-8-12			
 +AR	* VRS Message Function Assignment	1-8-13			
 +AU	* Automated Attendant Message Day/Night Mode Selection	1-4-11			
 +AU	Automated Attendant Message to Tenant Assignment	1-4-12			
 +AU	Automated Attendant Answer Delay Time Assignment	1-4-13			
 +AU	Automated Attendant Message Repeat Selection	1-4-16			
 +AU	Automated Attendant Delay Announcement Hold Tone Selection	1-4-17			

Order and Shortcut	System Data Name	Memory Block	Function	1-8-07 Attendant Page-Line Key	1-8-08 Station Page-Line Key
 +AU	* Automated Attendant Delay Announcement Assignment	1-4-18			
 +AU	* Automated Attendant 1 st to 2 nd Delay Announcement Interval Time	1-4-19			
 +AU	* Automated Attendant Delay Announcement Disconnect Time	1-4-20			
 +BCT	* Trunk Incoming Answer Mode Selection	3-05			
 +AU	Automated Attendant Message to Trunk Selection	3-38			
 +AU	* Automated Attendant Function Selection	3-59			
 +BA	* Access Code (1-, 2-, or 3-Digit) Assignment	1-1-46/47/48	501		
 +BTT	CO/PBX Ring Assignment (Day Mode)	4-01			
 +BTT	CO/PBX Ring Assignment (Night Mode)	4-02			
 +BTS	Class of Service (Attendant) Feature Selection 1	1-8-07		1-8	
 +BTS	Class of Service (Station) Feature Selection 2	1-8-08			2-6

* When the system is at default this Memory Block **must** be programmed for the feature to be used.

THIS PAGE INTENTIONALLY LEFT BLANK

FEATURE DESCRIPTION

The Automated Attendant answers incoming CO/PBX calls and sends a greeting message for calling parties. When the caller enters a station number or a 1- or 2-digit number from the dial pad, as instructed in the greeting message, the Automated Attendant then transfers the call to a designated station or Station Hunt group. The Automated Attendant can be set to provide two automated answering levels.

Incoming DID calls can be answered by the Automated Attendant.

SYSTEM AVAILABILITY

Terminal Type

Not applicable.

Required Components

VRS(4)-U() ETU

OPERATING PROCEDURES

To record an Automated Attendant Message:

1. Go off-hook.
2. Dial the VRS Voice Message Record/Verify/Erase Access Code (e.g., $\textcircled{5}$ $\textcircled{0}$).
3. Dial operation:
 - $\textcircled{1}$ = Recording
 - $\textcircled{2}$ = Confirmation
 - $\textcircled{3}$ = Erasing
4. Dial operation:
 - $\textcircled{1}$ = Automated Attendant
 - $\textcircled{2}$ = Voice Prompt Message
 - $\textcircled{3}$ = Delay Announcement
5. Enter Automated Attendant Message ($\textcircled{1}$ $\textcircled{8}$).
6. Enter Mode:
 - $\textcircled{1}$ = Day Mode
 - $\textcircled{2}$ = Night Mode
 - $\textcircled{3}$ = Weekend Mode
7. Record Message.
8. Go on-hook.

To set the Automated Attendant Mode from the Attendant Position:

1. Press **Feature**.
2. Dial **8** **7**.
3. Dial the incoming trunk number (**0** **0** ~ **6** **4**). [**0** **0** = All CO/PBX lines.]
4. Dialling 00 sets or cancels the Automated Attendant mode for all trunks when the trunks are idle. If a trunk is busy when 00 is Dialed, it is not set. To set the Automated Attendant to a busy trunk, dial the individual trunk number.
5. Press **Feature**.

To cancel the Automated Attendant Mode from the Attendant Position:

1. Press **Feature**.
2. Dial **8** **2**.
3. Dial the incoming trunk number (**0** **0** ~ **6** **4**). [**0** **0** = All CO/PBX lines.]

Note: Dialling 00 sets or cancels the Automated Attendant mode for all trunks when the trunks are idle. If a trunk is busy when 00 is Dialed, it is not set. To set the Automated Attendant to a busy trunk, dial the individual trunk number.

4. Press **Feature**.

To set/cancel the Weekend Mode from the Attendant Position:

1. Press **Feature**.
2. Dial **8** **6**.
3. Dial tenant number (**0** **0** ~ **4** **7**).

Note: Dialling 00 sets or cancels the Automated Attendant mode for all trunks when the trunks are idle. If a trunk is busy when 00 is Dialed, it is not set. To set the Automated Attendant to a busy trunk, dial the individual trunk number.

4. Press **Feature**.

To answer by One Level:

1. Receive an incoming CO/PBX call.
2. The Automated Attendant answers the call and sends a greeting.
3. A DTMF tone is received. (Each tone is assigned to a station number or a station hunt group.)
4. The call is transferred to a designated station or station hunt group.
5. The called party answers and talks.

To answer by Multiple Levels (up to eight levels are available):

1. Receive an incoming CO/PBX call.
2. The Automated Attendant answers the call and sends a greeting.
3. A 1-digit DTMF tone is received. (Each tone is assigned to another message on the VRS ETU).
4. The call is answered by the VRS ETU and another message is played.
5. A 1-, 2-, or 3-digit DTMF signal is received.
6. The call is transferred to a designated station of the second level, or another VRS ETU message is played.
7. The called party answers and talks.

Timeout - No Answer :

1. An incoming CO/PBX call is received on a line.
2. The Automated Attendant answers the call and sends a greeting.
3. A 1-digit DTMF tone is received.
4. The call is transferred to a designated station or Station Hunt group.
5. If there is no answer, the CO/PBX ringing transfer at the station is changed to an ordinary CO/PBX ringing call on the CO/PBX line, after a predetermined time.
6. The calling party on the CO/PBX line is answered.

**SERVICE
CONDITIONS****Data Assignment**

- ④ A maximum of two VRS(4)-U() ETU's, four channels per card, can be used for Automated Attendant.
- ④ Each channel has 240 recording seconds that can be subdivided into 2, 4, 8, or 16 equal recording times.
- ④ A maximum of eight Automated Attendants can be assigned. Multiple Automated Attendants can be assigned to one VRS(4)-U() ETU channel.
- ④ Memory Block 1-4-02 (Automated Attendant Transfer Delayed Ringing Time Selection) is not required to time out before incoming DID calls can be answered by the Automated Attendant (can be set to No Limit).
- ④ Use Memory Block 1-4-08 (Automated Attendant PBR Timeout Response Selection) to specify how a call is answered by the Automated Attendant if DTMF tone is not received. If NORMAL Call is specified (default), the system rings selected stations using Memory Block 4-01[CO/PBX Ring Assignment (Day Mode)] or 4-02 [CO/PBX Ring Assignment (Night Mode)]. When RELEAS is specified, the call is dropped after a fixed time of 30 seconds.
- ④ Use Memory Block 1-4-09 (Automated Attendant PBR Start Time Selection) to specify whether the PBR can receive DTMF signalling while the Automated Attendant is sending the message (default: FR) or after the message is finished (AF).
- ④ Use Memory Block 1-4-11 (Automated Attendant Message Day/Night Mode Selection) to assign the Day/Night/Weekend mode greeting messages to each Automated Attendant position.
- ④ Use Memory Block 1-4-13 (Automated Attendant Answer Delay Time Assignment) to set the answering time (default: 4 seconds) between when the incoming CO/PBX call rings and when it is answered. This time affects the Day/Night/Weekend mode settings per Automated Attendant.
- ④ Use Memory Block 1-4-16 (Automated Attendant Message Repeat Selection) to assign the number of times a greeting message is repeated (default: 1).
- ④ Use Memory Block 1-4-21 (Automated Attendant Extensions Number Assignment) to specify the message that is played when a DID call is received.
- ④ Use Memory Block 1-4-22 (Automated Attendant Direct Extension Ring Assignment) to direct an AA Call to an extension or CAR Key once the AA PBR timer has expired. Calls cannot be directed to a CAR Key if 2 digit extension numbers are used.
- ④ Use Memory Block 1-8-07 [Class Of Service (Attendant) Feature Selection 1] Page 1 LK8 to Allow (default: LED On) or Deny (LED Off) Attendant Positions to set/reset the Automated Attendant per trunk.

- ④ Use Memory Block 1-8-08 [Class Of Service (Station) Feature Selection 2] Page 2 LK6 to Allow (default: LED On) or Deny (LED Off) a station to record, verify, or erase an Automated Attendant message.
- ④ Use Memory Block 1-8-01 to specify whether the PBR circuits in the CPU(I) are used for Single Line Telephone or Automated Attendant/DISA.
- ④ Use Memory Block 3-05 (Trunk Incoming Answer Mode Selection) to assign Automated Attendant per CO/PBX line.
- ④ Use Memory Block 3-65 (Hold Tone Automated Attendant Selection) to specify the message to be played to an extension or DID trunk on an incoming call.
- ④ Use Memory Block 4-58 (Automated Attendant Selection for DID) to specify the message for DID calls.
- ④ Use Memory Block 7-1 (Card Interface Slot Assignment) to specify the VRS(4)-U() ETU.

Restrictions

- ④ Tie/DID lines are not supported by the Automated Attendant feature.
- ④ CPU-based PBR circuits are required and used for this feature. The CPU-I-U() ETU of the Xen IPK system has four built-in PBR circuits that are programmable for use with the Automated Attendant, DISA feature, or Single Line Telephones. If all four circuits are programmed for AA/DISA use, then a PBR()-U() ETU must be installed for Single Line Telephone use.
- ④ Automatic Trunk-to-Trunk Transfer and the Automated Attendant features cannot be set for the same trunk at the same time.

General

- ④ If the VRS(4)-U() ETU or PBR is busy and there is an incoming CO/PBX/DID call, the caller hears a ringback tone until a VRS channel and PBR are available.
- ④ If Automated Attendant or PBR is busy, after the call is transferred to the second level, a ringback tone is sent to the calling party.
- ④ DIT/ANA assigned to the same trunk has higher priority.
- ④ Automated Attendant and system Access Codes can be assigned individually.
- ④ Automated Attendant assignment is assigned to tenants and follows the tenants Day/Night/Weekend mode switching.
- ④ If Automated Attendant answer is assigned for a trunk and a VRS(4)-U() ETU is not installed, second dial tone is provided for incoming callers.

- ⓘ If an incoming caller is transferred to a busy station, the following options are available to this caller:









Dial	Action
1	Step Call is performed
*	Second dial tone is provided
#	Ringing begins based on the Day/Night ringing assignment

- ⓘ After recording a new Automated Attendant message, verify its operation by placing a call into the system and ensuring complete and correct playback. If you find that the message is ending prematurely or is automatically triggering the digit entry process, re-record the message using a different person with a lower pitched voice if possible.













RELATED FEATURES LIST

Feature Number	Feature Name
D-9	Direct Inward System Access (DISA)

GUIDE TO FEATURE PROGRAMMING

Order and Shortcut	System Data Name	Memory Block	Function	1-8-07 Attendant Page-Line Key	1-8-08 Station Page-Line Key
 +BS	Card Interface Slot Assignment	7-1			
 +BCT	Trunk Type Selection	3-91			
 +BCT	Trunk-to-Trunk Group Assignment	3-03			
 +AR	VRS Message Recording Time Selection	1-8-12			
 +AR	* VRS Message Function Assignment	1-8-13			
 +AU	Automated Attendant Extension Number Assignment	1-4-21			
 +AU	Automated Attendant Direct Extension Ring Assignment	1-4-22			
 +BA	* Access Code (1-, 2-, or 3-Digit) Assignment	1-1-46/47/48	501		
 +AU	* Automated Attendant Message Day/Night Mode Selection	1-4-11			

Order and Shortcut	System Data Name	Memory Block	Function	1-8-07 Attendant Page-Line Key	1-8-08 Station Page-Line Key
 +BTI	* SLT or Automated Attendant/DISA to PBR Selection	1-8-01			
 +BCT	* Trunk Incoming Answer Mode Selection	3-05			
 +AU	Automated Attendant Function Selection	3-59			
 +AU	Automated Attendant Message to Trunk Selection	3-38			
 +BM	Automatic Day/Night Mode by Day of Week Selection	1-1-32			
 +AU	Hold Tone Automated Attendant Selection	3-65			
 +AU	Automated Attendant Message to Tenant Assignment	1-4-12			
 +BTS	Class of Service (Attendant) Feature Selection 1	1-8-07		1-1, 1-2, 1-8, 2-7	
 +BTS	Class of Service (Station) Feature Selection 2	1-8-08			2-6
 +BTT	Station to Class of Service Feature Assignment	4-17			
 +AU	Automated Attendant Message Access Code (1-Digit) Assignment	1-4-14			
 +AU	Automated Attendant Message Access Code (2-Digit) Assignment	1-4-15			
 +BA	Specified Station Access Code Assignment	1-2-08			
 +AU	Automated Attendant Answer Delay Time Assignment	1-4-13			
 +AU	Automated Attendant Message Repeat Selection	1-4-16			
 +AU	Automated Attendant PBR Start Time Selection	1-4-09			
 +AU	Automated Attendant First Digit PBR Release Time Selection	1-4-01			
 +AU	Automated Attendant Selection for DID	4-58			
 +AU	Automated Attendant PBR Timeout Response Selection	1-4-08			
 +AU	PBR Receive Level Assignment for Automated Attendant/DISA	1-8-02			
 +AU	Automated Attendant Transfer Delayed Ringing Time Selection	1-4-02			

Order and Shortcut	System Data Name	Memory Block	Function	1-8-07 Attendant Page-Line Key	1-8-08 Station Page-Line Key
 +AU	Automated Attendant Transfer Ring Pattern	1-1-54			
 +AU	Automated Attendant No Answer Disconnect Time Selection	1-4-03			
 +AU	Automated Attendant Delay Announcement Hold Tone Selection	1-4-17			
 +ALN	DID Digit Length Selection	1-1-20			
 +ALN	DID Digit Conversion Assignment	1-1-21			
 +ALN	DID Digit Conversion Table	1-1-22			
 +ALN	DID Forward Station Number for Busy Station or Undefined Digit	1-1-23			
 +BTM	Line Key Selection for Telephone Mode	4-12			
 +BTT	CO/PBX Ring Assignment (Day Mode)	4-01			
 +BTT	CO/PBX Ring Assignment (Night Mode)	4-02			
 +BI	Tone Assignment	1-8-15	Tone Table 01		
 +AT	Tandem Transfer SMDR Print Extension Assignment	1-4-04			
 +BM	Automatic Day/Night Mode Switching Time Assignment	1-1-27			

* When the system is at default this Memory Block **must** be programmed for the feature to be used.

Automatic Callback

A-19

FEATURE DESCRIPTION

After receiving a call waiting tone from a busy station, a user can set an Automatic Callback. When both stations are idle, the system signals the Automatic Callback originator first and, after answered, signals the other station.

SYSTEM AVAILABILITY

Terminal Type

All terminals.

Required Components

None.

OPERATING PROCEDURES

To use this feature after calling a busy station and receiving a call waiting tone:





1. Dial Automatic Callback Access Code 0 (set as default).
2. Hang up.
3. The originating station rings when both stations become idle.
4. Lift the handset or press .
5. Receive tone burst or ringback tone; talk when the called station user answers.

SERVICE CONDITIONS

Data Assignment

-  The Access Code can be changed to one of the following: *, #, or 1~9.





Restrictions

-  Only one Automatic Callback at a time may be set at a station.
-  Automatic Callback cannot be set to a station that is in Do Not Disturb mode.
-  Call Pickup Group feature does not pickup Automatic Callback ringing on the originator station.
-  Automatic Callback setting is automatically cancelled unless both stations become idle within 30 minutes (set as default).

General

- ④ Any station can be used for setting an Automatic Callback. An Automatic Callback can be set to multiple stations regardless of tenants.
- ④ If the user that set an Automatic Callback receives the Callback and does not answer within 30 seconds after the ringing begins, the Callback is automatically released.
- ④ While set, a Callback cannot be manually cancelled.

GUIDE TO FEATURE PROGRAMMING

Order and Shortcut	System Data Name	Memory Block	Function	1-8-07 Attendant Page-Line Key	1-8-08 Station Page-Line Key
 +BTS	Class of Service (Station) Feature Selection 2	1-8-08			1-3
 +BTT	Station to Class of Service Feature Assignment	4-17			
 +BA	Intercom Feature Access Code Assignment	1-2-24	004		
 +BM	Automatic Callback Release Time Selection	1-2-02			

Automatic Call Distribution (ACD)

A-20

FEATURE DESCRIPTION

The Automatic Call Distribution (ACD) feature permits any incoming calls (DIT, ANA, DID, and CO Ring Transfer) to a prearranged ACD Group of Agents. An incoming call is distributed to the Agent of the ACD Group that has been idle the longest. The ACD feature has four distinct parts: Call Distribution, Agents and Supervisor Function, Status screens and Management Information System (MIS) reports, and Delay Announcement.

SYSTEM AVAILABILITY

Terminal Type

All terminals.

Required Components

MIFA-U() ETU

KMA()-UA for ACD/MIS

VRS(4)-U() ETU for Delay Announcement.

OPERATING PROCEDURES

Refer to the Automatic Call Distribution Manual:

GENERAL DESCRIPTION

CALL PROCESSING

This section includes the following features:

Abandoned Call Search

Abandoned incoming calls are not connected to Agent Positions. The system can recognize abandoned calls and remove them from the queue on trunks that provide calling party disconnect supervision.

Call Distribution to Agents

Calls are automatically distributed in a uniform manner among Agents in an ACD Group. Calls are distributed to the longest idle Agent Position. When incoming calls are holding, the oldest call is connected to the first available Agent position.

Call Transfer to ACD Group Queue

CO Trunk calls that have terminated to either a normal station, ACD Agent, or Supervisor Position may be transferred to an ACD group queue.

Night Service

When the ACD group is placed in Night Mode, the system can route all incoming ACD calls to one of the following: Internal Station, Night Announcement, transfer to the Attendant, or Trunk-to-Trunk Transfer.

Overflow

Overflow Service allows calls held in queue for more than a predetermined time to be directed to an assigned station or Station Hunt group, but not to overflow to another group.

Queuing

All incoming calls destined for ACD groups are placed in queue when no Agent in the ACD group is presently available to handle the call. Queue is used to provide service in order of arrival (*first in-first out*).

Pilot Numbers

Pilot numbers are the Access Codes to ACD functions. They are programmed into the System Data according to the numbering plan in effect for the system. Pilot numbers do not correspond to any line appearances in the Xen IPK system. No hardware equipment is required to assign a Pilot number. An ACD Group Pilot number should not be programmed in a Station Hunt group. The Station Hunt feature takes priority over the ACD function.

SERVICE CONDITIONS

Data assignment

Restrictions

- ⓘ No alert tone is provided even if all Agents in the ACD group are busy. However, Pooled Line (Outgoing) can indicate the status of trunks in an ACD group as an alternative method.

General

- ⓘ If the Agent (in the ACD group where a call is terminated) does not answer for a predetermined time, the call is transferred to another Agent in the ACD group.
- ⓘ If the Agents (in the ACD group where a call is terminated) are all busy, the call waits in a queue until an Agent is available. The caller receives a Delay Announcement and Music On Hold. Calls are answered first-in, first-out.
- ⓘ When the overflow destination station is busy, calls continue searching the ACD group for an available Agent.
- ⓘ When an incoming call to an ACD group encounters all ACD Agents busy or no answer, the call is queued and the caller receives a recorded announcement (Delay Announcement) after a predetermined time.
- ⓘ The ACD group is assigned a Pilot number. Calls directed to the Pilot number are directed to Agents of that ACD group.

- ④ The following maximum assignments for programming ACD groups and Agents are:
 - Up to 32 Agents can be programmed per system.
 - Up to four ACD Groups can be assigned per system.
- ④ Up to 32 Agents can be assigned in one ACD group.
- ④ All trunks used for ACD incoming calls must provide a receiving remote disconnect signal to release abandoned calls.
- ④ Overflow is performed only once.
- ④ When the overflow destination station is set to Call Forward to an ACD Group, overflow does not occur.
- ④ A Voice Mail Hunt group can be assigned as the destination station for ACD overflow; however, no DTMF digits are sent to the voice mail system.

AGENT AND SUPERVISOR FUNCTION

GENERAL DESCRIPTION

This section includes the following features:

Assistance

This feature allows an Agent to call a Supervisor, in the ACD group, for assistance. Activation of this feature, while on an ACD call, automatically places the active call on hold and places an assistance call to the Supervisor. This feature uses a Feature Access or One-Touch key.

Break Mode

This feature allows the Agent to take a position out of the ACD mode without logging off. Break Mode is used for breaks from work (e.g., lunch or coffee breaks). This feature uses the DND key that is programmed on a Feature Access or One-Touch key.

Logon/Logoff

This feature allows an Agent to logon/logoff the system. Operating statistics are collected for the Agent until they logoff. This feature is activated by the Logon/Logoff key that is programmed on a Feature Access or One-Touch key on the Agent Position.

Non-ACD Call

This feature allows Agents or Supervisors to receive calls directly from dial trunks (e.g., Tie line, DID, or DIT) or transferred calls to the agent. The following ACD calls are counted as non-ACD calls by MIS when they are picked up by Agents in another group: transferred ACD calls from another Agent or ACD calls on hold by another Agent.

Answer/Release-Headset

This feature allows an Agent, that is using a headset, to answer or release an ACD call. This feature uses the Headset On/Off key that is assigned on a line key in System Programming.

Volume Control-Headset

This feature allows Agents to control the receiving level at their station, independent of the level of the incoming calls.

Control of Night Mode

This feature allows the Supervisor to activate Night Mode. This feature can be activated and deactivated by the NT key that is programmed on a Feature Access or One-Touch key on the Supervisor terminal.

Monitoring (Barge-In)

This feature allows the Supervisor to monitor calls at an Agent Position. This feature is activated by key operation on the Supervisor Terminal. During monitoring, the Conference LED lights at both terminals involved.

**SERVICE
CONDITIONS****Restrictions**

- ④ An alert tone is provided for the Monitoring feature.
- ④ Agents can log off or enter Break Mode from their station only when it is idle.
- ④ While an ACD Agent is logged on, Call Forwarding set at this station does not function.
- ④ ACD Agents do not receive another ACD call if an existing ACD call is on hold or is call parked. When the held or call parked call is terminated, the ACD Agent can receive ACD calls again.
- ④ For correct MIS reporting, agents should exit Break Mode before logging off.
- ④ If an agent logs on with an outside call on hold, the status of the agent on the MIS terminal will show Available, but the system will not distribute an ACD call to the agent until the held call is terminated or transferred to another user.

General

- ④ Break Mode Set allow/deny is assigned by Class of Service.
- ④ When calls are transferred to an ACD Pilot number using Call Appearance keys, these keys stay lit until the calls are answered and released by Agents.
- ④ While the Agent is in Break Mode, the Busy Lamp Field (BLF) flashes red.

- ⓘ Any Agent in an ACD group can busy their station out by pressing the Logoff key on the Multiline Terminal. When log off is activated, station users can receive calls directed to their station number (but not the ACD group number) and originate calls.
- ⓘ During Break Mode, incoming ACD calls cannot be received.
- ⓘ ACD MIS interfaces with the Xen IPK MIS application software.



RELATED FEATURES LIST

Feature Number	Feature Name
D-2	Delay Announcement

GUIDE TO FEATURE PROGRAMMING

Order and Shortcut	System Data Name	Memory Block	Function	1-8-07 Attendant Page-Line Key	1-8-08 Station Page-Line Key
+BS	Card Interface Slot Assignment	7-1			
+BS	MIF (ACD) Assignment	7-3-00			
+BA	* Access Code (1-, 2-, or 3-Digit) Assignment	1-1-46/47/48	031, 032, 040		
+AA	* ACD/UCD Group Pilot Number Assignment	1-12-00			
+AA	* ACD/UCD Group Agent Assignment	1-8-25			
+BTS	Class of Service (Station) Feature Selection 2	1-8-08			1-1, 1-4, 1-5
+BTT	Station to Class of Service Feature Assignment	4-17			
+AA	ACD/UCD Group Overflow Destination Assignment	1-12-01			
+AA	ACD/UCD Overflow Time Selection	1-12-02			
+BCT	DIT Assignment	3-42			
+BCT	ANA Assignment	3-43			
+BTM	Line Key Selection for Telephone Mode	4-12			
+BTM	Extension Line Key Ring Assignment (Day Mode)	4-37			

Doc. No. 8201 - Release 1.0
July 2003

Order and Shortcut	System Data Name	Memory Block	Function	1-8-07 Attendant Page-Line Key	1-8-08 Station Page-Line Key
 +BTM	Extension Line Key Ring Assignment (Night Mode)	4-38			
 +AA	ACD Hunt Time	1-8-40			

* When the system is at default this Memory Block **must** be programmed for the feature to be used.

Automatic Call Distribution (ACD Plus)

A-21

FEATURE DESCRIPTION

The NEC ACD Plus is an Automatic Call Distribution ETU that supports up to 40 agents and 12 supervisors. This feature allows any incoming DIT, ANA, DID, or CO Ring Transfer call to terminate at a prearranged ACD Group of agents. The incoming call is either distributed to the agent that has been idle the longest or in accordance with a programmed preference level. Operation includes Automatic Attendant (AA), ACD only, or both AA and ACD.

The administration Program uses a Local Area Network (LAN) that allows one administrator and up to five remote PCs, depending on site license, to monitor ACD statistics and generate reports.

An agent or supervisor can be an active member in up to four ACD Groups and can be logged on and receive calls from all four groups.

SYSTEM AVAILABILITY

Terminal Type

Multiline Terminals with display and softkeys.

Required Hardware Components

ACD(8)-U() ETU

OPERATING PROCEDURES

Refer to Automatic Call Distribution Manual.

GENERAL DESCRIPTION

CALL PROCESSING

Abandoned Call Search

Abandoned incoming calls are not connected to agent positions. The system removes them from the queue on trunks that provide calling party disconnect supervision.

Call Distribution Agents

Two methods can be used:

Ⓢ Longest Idle

Calls are automatically and uniformly distributed to the agent in an ACD Group that has been idle the longest. When incoming calls are holding the oldest call is connected to the first available agent.

Ⓢ Preferred

Calls are automatically distributed among idle agents according to an assigned priority level of 1 (first) to 9 (last). If agents have the same priority, the system connects the call to the longest idle agent in that priority.

Call Transfer to ACD Group Queue

CO Trunk calls that terminate to a normal station, ACD agent, or supervisor can be transferred to an ACD Group Queue.

Night Service

The administration program assigns ACD Groups to follow or ignore night mode. When an ACD Group is in night mode, the system routes incoming ACD calls to an Internal Station, Night Announcement, transfer to Attendant, or Centrex Transfer.

Overflow

If all agents are busy and, calls have been held in queue for more than a specified time, overflow allows calls to be directed to an assigned station, Station Hunt Group, another queue, or Off-site using Centrex Transfer.

Queuing

All incoming calls for ACD Groups are placed in queue if no agent is available. A queue provides first in-first out sequence for call processing.

Pilot Numbers

A system programmed pilot number is the entry point for callers to an ACD Group. A pilot number corresponds to a Call Arrival key appearance in the Xen IPK system. Each queue has an individual CAR key. An ACD Group Pilot Number must not be programmed in a station hunt group because Station Hunt has priority over ACD.

SERVICE CONDITIONS

Data Assignment:

- ④ The ACD Plus hardware connects to the Xen IPK through ports the KSU recognises as Voice Mail ports. Eight ACD ports are supported.
- ④ Voice Prompts and firmware are stored in Flash Memory on the ACD(8)-U() ETU. Firmware upgrades are programmed using a serial port on the ETU.
- ④ For correct operation the CF-BNA timer in Memory Block 1-2-22 should be set to at least 6 seconds longer than the agent rings without answer field in the ACD Administration Application.

Restrictions:

- ④ Up to 40 agents and 12 supervisors can be logged in at the same time to any or all ACD queues, depending on programming
- ④ If the agent in the ACD Group where a call terminates does not answer after a programmed time, the call is put back in the queue and the agent is logged off. If auto logout is disabled, the call goes to the next available agent or follows overflow.
- ④ One system administrator can be connected to the server at a time.
- ④ Up to five remote monitors can be connected to the server at the same time.

General:

- ④ Calls are answered first in-first out
- ④ Calls are distributed to the longest-idle agent or according to the priority level assigned to an agent.
- ④ ACD Plus can be programmed per queue to follow or ignore night mode.
- ④ Maximum programming assignments for ACD Groups and Agents are listed below:
 - 120 Agents per system
 - 12 Supervisors per system
 - 120 Agents can be assigned to one ACD Group
 - 40 Agents and 12 Supervisors can be logged in at the same time.
 - Four ACD Groups per system

GENERAL DESCRIPTION**AGENT AND SUPERVISOR FUNCTION****Assistance**

During an ACD call, An agent can press a programmed Feature Access or One-touch key to automatically place the active call on hold and call the supervisor for assistance.

Break Mode

The agent can use a softkey to take a position out of ACD Mode for a break from work without logging off.

Wrap Mode

The agent can use a softkey to take a momentary break to process the previous call. This allows the agent to finish paper work and discuss the call with a supervisor.

Logon/Logoff

An agent can logon by dialling the pilot number for the ACD port and following displayed prompts. Operating statistics are collected until the agent performs logoff. The agent can press the logoff softkey on the agent position to logoff.

Non-ACD Call

An agent or supervisors can receive a transferred call or a call directly from dial trunks (e.g., Tie Line, DID, or DIT). Transferred ACD calls from another agent or ACD calls on hold by another agent are counted as non-ACD calls by MIS if they are picked up by agents in another Group.

Headset Answer/Release

An agent using a headset can press a programmed Headset On/Off Line Key to answer or release an ACD call.

Headset Volume Control

An agent can control the volume of the headset independently of the volume of the handset.

Control of Night Mode

The supervisor can activate or deactivate Night Mode using an NT key programmed on a Feature Access or One-Touch key on the supervisor terminal. A supervisor can also place an individual queue in night mode using softkeys once logged on. Each queue can be set to follow or ignore system night mode. If a queue is set to ignore, it can be placed in night mode only if the supervisor logs in and manually places it in night mode using softkeys.

Monitoring (Barge-In)

The supervisor can monitor calls at an agent position using a key operation on the supervisor terminal. The conference LED is on at each involved terminal during monitoring.

**SERVICE
CONDITIONS****Data Assignment:**

- Ⓢ A default alert tone is provided for Barge-In Monitoring.

Restrictions:

- Ⓢ An agent can logoff or enter Break or Wrap mode only when the station is idle. The agent can request these conditions by pressing the applicable softkey during an ACD call. The last entered request is carried out when the telephone returns to idle.
- Ⓢ An agent cannot receive another ACD call while an existing ACD call is on hold. After the held call is terminated, the agent can then receive ACD calls.
- Ⓢ Agents and supervisors must have a multiline terminal with display and softkeys.
- Ⓢ Agent telephones always follow forwarding including ACD calls. The forwarding timers must be verified to ensure that they do not conflict with agent operation or the automatic logout.
- Ⓢ Incoming ACD calls cannot be received during Break or Wrap Mode.

General

- Ⓢ The LED for a Call Appearance key used to transfer a call to an ACD pilot number remains on until the call is answered by the ACD card.
- Ⓢ While an agent is logged on, call forwarding set at this station functions and includes calls transferred from ACD.
- Ⓢ After the agent dials the ACD(8)-U() ETU, all agent functions are accessed using softkeys.
- Ⓢ Any agent in an ACD Group can press their logoff key to busy out the station. The station user can then originate calls or receive calls directed to the station number but not to the ACD Group number.

**GENERAL
DESCRIPTION*****AUTOMATED ATTENDANT FUNCTION*****Restrictions**

- ④ Supervisors can record AA and ACD queue messages again using the telephone. The maximum message length is 90 seconds.
- ④ This feature allows a caller to direct dial a valid extension defined by the Administration application or one-key dialling only while a message is playing.
- ④ If caller does not select an AA transfer option within eight seconds, after the AA message finishes playing, the caller is automatically transferred to the default transfer number. If a default transfer number is not assigned, the AA message replays after eight seconds.
- ④ ACD Plus can be programmed to answer lines with AA while sending others directly to the ACD queue.

General

- ④ The AA can transfer a call to any valid telephone number using Centrex service. After the call is transferred at the Central Office, it cannot use any Xen IPK trunk lines.
- ④ Additional hardware is not required to support Automated Attendant.

**GENERAL
DESCRIPTION*****ANNOUNCEMENT FUNCTION*****General**

By default, all announcements except the AA and On-Hold message are recorded. Using the Administration program, most messages can be allowed or denied per group. Both AA messages and the Numbers message are shared by all groups. The supervisor can login by telephone to ACD and change any message if granted access rights for the group. Recordings can also be changed using the Administration program by downloading a voice file in the correct format from the PC.

Automated Attendant Messages

There is a standard greeting that is not recorded at default and an error message that plays if an invalid selection is dialled. Both messages are shared by all groups.

ACD Greeting Message

A caller hears this message that is recorded per group if agents are not available to answer a call. The Administration program can set this message to play first even if there are idle available agents.

Numbers Message

This message shared by all groups can be recording by the Supervisor using a telephone and contains the numbers played for queue depth. During recording by telephone, the number to speak is shown in the display. If a voice file from a PC is used, the message must be in *indexed play format* or the queue depth feature does not work.

ACD On-Hold Message

This message (recorded and enabled per group) plays after the ACD Greeting and Refresh 1 and Refresh 2 messages. By default this message is not recorded.

ACD Refresh Message 1

This message (recorded and enabled per group) plays at programmed intervals for callers that remain in queue. It plays after the ACD Greeting and before ACD Refresh Message 2.

ACD Refresh Message 2

This message (recorded and enabled per group) plays at programmed intervals for callers that remain in queue. It plays after the ACD Greeting, ACD Refresh Message 1, and On-Hold messages.

Night Message

This message (recorded and enabled per group) is played when a group is in night mode and the message is enabled for that queue.

ACD Queue Status Header

This message (recorded and enabled per group) is used with the queue depth feature to indicate the place in the queue. By default it states: "you are caller number" followed by the prompt that plays the correct place for the caller.

ACD Queue Status Trailer

This message (recorded and enabled per group) is played after the Queue status header and Numbers Message. This message states: "in queue".

Data Assignment

- ④ The answering time after the incoming CO/PBX call rings is programmable per trunk when using Automated Attendant.

















Restrictions

- ④ The maximum length of messages is 90 seconds.
- ④ DIT/ANA, CO Ring transfers, AA transfers, or DID/Tie Line calls must be directed to an ACD pilot number to receive announcements.
- ④ If all ACD ports are busy, the incoming caller continues to hear ringback tone or Music on Hold until an ACD port is available.
- ④ Only eight calls can be connected to the ACD(8)-U() ETU and receive announcements at the same time. A maximum of 64 trunks can be supported.

General

- ☎ If all agents in the ACD group where a call is terminated are busy, the call waits in queue until an agent is available. The caller receives announcements, queue depth indication or Music on Hold.
- ☎ Each caller hears every announcement from the beginning.
- ☎ When an agent becomes available, the caller is immediately connected even if an announcement is in progress.

GUIDE TO FEATURE PROGRAMMING

Order and Shortcut	System Data Name	Memory Block	Function	1-8-07 Attendant Page-Line Key	1-8-08 Station Page-Line Key
 +BS	Card Interface Slot Assignment	7-1			
 +BS	Telephone Type Assignment	7-2			
 +BK	* Call Arrival Key Block Assignment	1-2-04			
 +BA	* Access Code (1-, 2-, 3-Digit) Assignment	1-1-46~48	063, 064		
 +BTS	* Class of Service (Station) Feature Selection 2	1-8-08			6-5
 +BCT	DIT Assignment	3-42			
 +BCT	ANA Assignment	3-43			
 +BTT	CO/PBX Ring Assignment (Day Mode)	4-01			
 +BTT	CO/PBX Ring Assignment (Night Mode)	4-02			
 +BS	Station Number Assignment	4-10			
 +BTM	Line Key Selection for Telephone Mode	4-12			
 +BTT	* Intercom Master Hunt Number Selection	4-14			
 +BTT	* Intercom Master Hunt Number Forward Assignment	4-15			
 +BTT	Station to Class of Service Feature Assignment	4-17			
 +BTM	Extension Line Key Ring Assignment (Day Mode)	4-37			
 +BTM	Extension Line Key Ring Assignment (Night Mode)	4-38			
 +BTT	MOH or Ring Back Tone Selection	4-66			

* When the system is at default this Memory Block **must** be programmed for the feature to be used.

THIS PAGE INTENTIONALLY LEFT BLANK

Automatic Carrier Routing

A-22

FEATURE DESCRIPTION

Automatic Carrier Routing (ACR) allows an outgoing line to be seized using a Trunk Group or Route Advance Block (RAB) for each number dialed by the user. The ACR feature allows better use of the trunks connected to the system.

SYSTEM AVAILABILITY

Terminal Type:

All terminals.

Required Components:

None.

OPERATING PROCEDURES

To use this feature:

1. Lift the handset, and wait for dial tone.
2. Dial ACR access code 0 (default) and receive LCR dial tone.
3. Dial the desired number.

SERVICE CONDITIONS

Data Assignments

- ④ Use Memory Block 1-1-46~48 [Access Code (1-, 2- or 3-Digit) Assignment] (Function No.101) to assign an access code.
- ④ Use Memory Block 3-03 (Trunk-to-Trunk Group Assignment) to make Trunk-to-Trunk Group Assignment.
- ④ Use Memory Block 4-40 (LCR Class Selection) to specify the LCR Class (default: 0) for each station.
- ④ Use Memory Block 1-8-08 [Class of Service (Station) Feature Selection 2] Page 6 LK1 to program Trunk Groups 2~32 to Allow (LED On) or Deny (default: LED Off) ACR Bypass.

Restrictions















- ④ Route Advance Blocks or Trunks programmed on a line key, bypass ACR.
- ④ ACR is not available when the Xen IPK system is in KF registration.
- ④ Outgoing calls using Direct Inward System Access (DISA) cannot access ACR.
- ④ ACR cannot be used to route calls by hour of day or day of week.

- ④ Only a single Route Assignment can be specified for each Dialling Assignment entry.
- ④ When ACR is set to YES (allow) using Memory Block 1-14-00 (ACR Allow/Deny Selection), the MIFM LCR is disabled even when allowed in system programming.
- ④ A maximum of 10 digits can be deleted or added to a Route Assignment.

General

- ④ All Trunk Groups in the system (00 is used to deselect trunk groups) can be accessed using ACR.
- ④ Trunk Group Access code 0 (default) activates ACR at stations assigned for LCR Class assignment using Memory Block 4-40 (LCR Class Selection).
- ④ ACR is based on actual digits dialled to properly route the call.
- ④ ACR can be programmed to consider a maximum of eight dialled digits before making a selection for the number dialled.
- ④ When using Code Restriction with ACR, code restriction applies to the digits dialled by the station user.
- ④ After an interdigit time of 10 seconds expires during dialling using ACR, a busy tone is generated, and the user must redial the number.
- ④ When a station user places an outgoing call using ACR, Trunk queuing cannot be set.
- ④ When a feature code is assigned to CO Feature Service code for Code Restriction using Memory Block 1-1-82 (CO Feature Code Service for Code Restriction), this code does not have to be programmed in the ACR Dialling Assignment Tables.
- ④ When ACR route assignment 00 is set using Memory Block 1-14-03 (ACR Route Table Number Assignment), the dialled number is sent out Trunk Group 01 the way the number was dialled.
- ④ The LCR/ACR access codes must be assigned to Trunk Group 1. Access to other Trunk Groups or Route Advance Blocks is then assigned through LCR/ACR Route assignments.
- ④ MAT must be disconnected after upload for ACR table to function correctly.
- ④ Intercom access may be programmed via the ACR tables allowing transparent dialling of extension numbers, external numbers and access codes.
- ④ Intercom Access Codes assigned in Memory Block 1-1-46/47/48 (with the exception of Feature Code 096, Last Number Redial) can be assigned in the ACR tables to allow these features to be invoked via ACR.

GUIDE TO FEATURE PROGRAMMING

Order and Shortcut	System Data Name	Memory Block	Function	1-8-07 Attendant Page-Line Key	1-8-08 Station Page-Line Key
 +BA	Access Code (1-, 2-, 3-Digit) Assignment	1-1-46/47/48			
 +BCT	Trunk-to-Trunk Group Assignment	3-03			
 +BCT	Trunk Type Selection	3-91			
 +BTT	LCR Class Selection	4-40			
 +BTS	* Class of Service (Station) Feature Selection 2	1-8-08			3-4, 6-1
 +BTT	Station to Class of Service Feature Assignment	4-17			
 +BTM	Line Key Selection for Telephone Mode	4-12			
 +AB	* ACR Allow/Deny Selection	1-14-00			
 +AB	* ACR Dialing Assignment	1-14-01			
 +AB	* ACR Dial Allow/Deny Selection	1-14-02			
 +AB	* ACR Route Table Number Assignment	1-14-03			
 +AB	* ACR Trunk Group to Route Number Assignment	1-14-04			
 +AB	* ACR Digit Delete Assignment	1-14-05			
 +AB	* ACR Digit Add Assignment	1-14-06			

* When the system is at default this Memory Block **must** be programmed for the feature to be used.

THIS PAGE INTENTIONALLY LEFT BLANK

Automatic Day/Night Mode Switching

A-23

FEATURE DESCRIPTION

This feature allows the system to be programmed to switch automatically in or out of the Night Mode at a preprogrammed time. This eliminates the need to manually set/reset the Night Mode daily. After a preprogrammed time, the system automatically switches back to Day Mode.

SYSTEM AVAILABILITY

Terminal type

Not applicable.

Required Components

None.

OPERATING PROCEDURES











Not applicable:

SERVICE CONDITIONS

Data Assignment

- ④ This assignment can be set for the time of day and the day of the week.
- ④ Two separate Day/Night Mode switch times are available. In any 24 hour period, the system changes from night mode to day mode at a specified time, then later the system changes from day mode back to night mode at a specified time.
- ④ Station Code Restriction Class Assignment may also change automatically when the system goes into Night Mode.
- ④ This feature switches Day/Night Mode for all tenants.
- ④ Station users can override this feature by manually setting the Day/Night Mode, if allowed by Class of Service assignment.

GUIDE TO FEATURE PROGRAMMING

Order and Shortcut	System Data Name	Memory Block	Function	1-8-07 Attendant Page-Line Key	1-8-08 Station Page-Line Key
 +BM	* Automatic Day/Night Mode Switching Time Assignment	1-1-27			
 +BM	* Automatic Day/Night Mode by Day of Week Selection	1-1-32			
 +BTS	Class of Service (Attendant) Feature Selection 1	1-8-07		1-1,1-2	
 +BM	Automatic Daylight Saving Time Selection	1-8-48			
 +BTT	CO/PBX Ring Assignment (Day Mode)	4-01			
 +BTT	CO/PBX Ring Assignment (Night Mode)	4-02			
 +BTM	Extension Line Key Ring Assignment (Day Mode)	4-37			
 +BTM	Extension Line Key Ring Assignment (Night Mode)	4-38			
 +AC	Code Restriction Class Assignment (Day Mode)	4-07			
 +AC	Code Restriction Class Assignment (Night Mode)	4-08			

* When the system is at default this Memory Block **must** be programmed for the feature to be used.

Automatic Hold

A-24

FEATURE DESCRIPTION

The Automatic Hold feature works when an Attendant with an Attendant Add-On Console presses a DSS key programmed for station or page access while engaged in an outside call or when Multiline Terminal users, engaged in an outside call, press a Feature Access key or One-Touch key programmed for Direct Station Selection or Direct Paging Access. This feature reduces the risk of accidentally disconnecting a call due to incorrect operation and simplifies access to various features by reducing the operational steps required.

SYSTEM AVAILABILITY

Terminal Type

Not applicable.

Required Components

None.

OPERATING PROCEDURES

While on an outside call at a Multiline Terminal:

1. Press the DSS/BLF key for the desired station or paging. The original call is automatically placed on Non-Exclusive Hold.
2. Talk with called party, or page.
3. Press the held line key or Call Appearance key to return to the held call.







SERVICE CONDITIONS

- ⓘ Any outside call on hold longer than the programmed time generates a recall at the originating Multiline Terminal.
- ⓘ Press the Transfer, Conference, or a DSS key, with a call in progress, to place the existing call on Non-Exclusive Hold.
- ⓘ Press the Answer key, with a call in progress and receiving an incoming CO/PBX call, to place the existing call on Hold and connect the Multiline Terminal user to the next call.
- ⓘ Press the Hold key to place the existing call on Non-Exclusive Hold or Exclusive Hold (if the Feature key and then the Hold key are pressed).

RELATED FEATURES LIST

Feature Number	Feature Name
A-8	Answer Hold

GUIDE TO FEATURE PROGRAMMING

Order and Shortcut	System Data Name	Memory Block	Function	1-8-07 Attendant Page-Line Key	1-8-08 Station Page-Line Key
 +BTD	Attendant Add-On Console to Telephone Port Assignment	1-6-01			
 +BTD	Attendant Add-On Console Key Selection	1-6-05			
 +BTM	Line Key Selection for Telephone Mode	4-12			
 +BTM	Extension Line Key Ring Assignment (Day Mode)	4-37			
 +BTM	Extension Line Key Ring Assignment (Night Mode)	4-38			
 +BM	Hold Recall Time Selection (Non-Exclusive Hold)	1-1-03			

THIS PAGE INTENTIONALLY LEFT BLANK

Automatic Redial

A-25

FEATURE DESCRIPTION

The Automatic Redial feature simplifies repetitive Dialling to a busy or unanswered outgoing call. When receiving a busy tone or no answer while attempting to make a CO/PBX call, the system periodically redials the party number while the station user monitors the call for completion.

SYSTEM AVAILABILITY

Terminal Type



All terminals.

Required Components

None.

OPERATING PROCEDURES

To set while receiving a busy tone or no answer on an outside call:

1. If using the handset, press  and restore the handset.
2. Press .
3. Press .
4. The call is repeated automatically (default: 2 times).
5. Lift the handset to respond when the called party answers. If this is not done, the call will be disconnected when the next redial cycle starts.

To cancel Automatic Redial:

1. Lift the handset, then restore handset, or press .

- OR -

Automatic Redial is cancelled automatically when the specified number of redials (default: 2 redials) are completed.

SERVICE CONDITIONS

Data Assignment

- Automatic Redial timeout options are programmable as follows:

Programming Range		Default
Callback Time	1~100 seconds	30 seconds
Wait Time	1~100 seconds	60 seconds
Redial Times	1~ 15 times	2 times



Restrictions

- The station retains sole use of the outside line during Automatic Redial.
- If an internal call is received during Automatic Redial, it cannot be answered unless Automatic Redial is released. The calling station receives a call waiting tone.
- This feature is not available for Single Line Telephones.
- This feature is not available for Tie/DID lines.

General

- This feature remains in effect until the party initiating the call lifts the handset during a redial attempt. An incoming call is received on that line, or two (depending on System Programming) redial attempts are made.
- The system does not detect an answer, no answer, or busy condition from the outside network.
- If Automatic Redial is in progress (a call is actually being initiated by the system), an LCD appearance (Q: Number Dialed) confirms Automatic Redial is activated. For stations with or without an LCD, a flashing Feature LED indication is provided, and the Redial key is steadily lit.
- The outside line LED on the Multiline Terminal, where Automatic Redial is initiated, is green but lights red on other Multiline Terminals in the system.
- If the feature times out, access a CO/PBX line, press the Feature key and then the Redial key, or a Feature Access or One-Touch key programmed for this feature, to reactivate it.
- If an incoming CO/PBX call is received from the CO during the waiting period of the Automatic Redial feature, Automatic Redial is released and a busy tone is sent to the station.
- A station user cannot set a Tone Override to a station with an Automatic Redial set. However, a Callback Request or an Automatic Callback can be set.
- The handset must be lifted off-hook to disable Automatic Redial after an outside call is answered.

GUIDE TO FEATURE PROGRAMMING

Order and Shortcut	System Data Name	Memory Block	Function	1-8-07 Attendant Page-Line Key	1-8-08 Station Page-Line Key
 +BM	Automatic Redial Time Selection	1-1-04			
 +BTS	Manual Pause Selection	1-1-09			

THIS PAGE INTENTIONALLY LEFT BLANK

Automatic Release

A-26

FEATURE DESCRIPTION

The Automatic Release feature releases the outside line circuit when an outside party has abandoned the call. For this feature to work with Loop Start Trunks, the CO/PBX providing the outside line must provide a line reversal signal or busy tone upon disconnect. Automatic release is also normally provided on DID, ISDN, and Tie Line Trunks.

SYSTEM AVAILABILITY

Terminal Type
Not applicable.

Required Components

COI()-U() ETU DID(4)-U() ETU
COID()-U() ETU TLI(2)-U() ETU
BRT(4)-U() ETU
PRT(1)-U() ETU

OPERATING PROCEDURES

Not applicable.

SERVICE CONDITIONS

General

- ☎ Loop Start, DID and TIE Line Trunks provide this feature if the outside exchange generates a line reversal signal to indicate the distant party has abandoned the call. Automatic Release on ISDN trunks is provided as part of the protocol.
- ☎ New Zealand loop start trunks do not provide automatic release by way of a line reversal signal.
- ☎ If an outside line has been accessed via a dedicated line key, the LED associated with the line key goes off when Automatic Release occurs.
- ☎ This feature functions while a call is in progress, on hold, or conferenced.
- ☎ The presence of a Busy Tone (Disconnect Tone in NZ) on the line, may also be used to automatically release the circuit when the outside party has abandoned the call.
- ☎ Automatic Release can be turned on or off via system programming.

THIS PAGE INTENTIONALLY LEFT BLANK

Automatic Trunk-to-Trunk Transfer

A-27

FEATURE DESCRIPTION

This feature allows an incoming CO/PBX call to connect to another CO/PBX trunk and dial a predetermined telephone number. This is especially useful for forwarding calls to an answering service during non business hours (*i.e.*, nights, weekends, holidays).

SYSTEM AVAILABILITY

Terminal Type:

Attendant Position terminals assigned for this ability.

Required Components:

None.

OPERATING PROCEDURES

To set the Trunk Forward Assignment from the Attendant Position:

1. Press **Feature**.
2. Dial **6** **3**.
3. Dial the incoming trunk number (**0** **1** ~ **6** **4** ,
4. Press **#**.
5. Dial outgoing telephone number where the call is to be directed.
6. Press **Feature**.

To cancel the Trunk Forward Assignment from the Attendant Position:

1. Press **Feature**.
2. Dial **6** **3**.
3. Dial the incoming trunk number **0** **1** ~ **6** **4** , **0** **0**)
4. Press **#**.
5. Press **Feature**.

Note: Dialling 00 sets or cancels the Automated Attendant mode for all trunks when the trunks are idle. If a trunk is busy when 00 is dialled, it is not set. To set the Automated Attendant to a busy trunk, dial the individual trunk number.

To set the Automatic Trunk-to-Trunk Transfer Mode from the Attendant Position:

1. Press **Feature**.
2. Dial **6** **1**.
3. Dial the incoming trunk number (**0** **1** ~ **6** **4** , **0** **0**)
4. Press **Feature**.

Note: Dialling 00 sets or cancels the Automated Attendant mode for all trunks when the trunks are idle. If a trunk is busy when 00 is dialled, it is not set. To set the Automated Attendant to a busy trunk, dial the individual trunk number.

To cancel the Automatic Trunk-to-Trunk Transfer Mode from the Attendant Position:

1. Press **Feature**.
2. Dial **6** **2**.
3. Dial the incoming trunk number (**0** **1** ~ **6** **4** , **0** **0**)
4. Press **Feature**.

Note: Dialling 00 sets or cancels the Automatic Trunk-to-Trunk Mode for all trunks when the trunks are idle. If a trunk is busy when 00 is dialled, it is not set. To set Automated Trunk-to-Trunk mode to a busy trunk, dial the individual trunk number.

To confirm the Trunk Forward Assignment from the Multiline Terminals with a LCD:

1. Press **Feature**.
2. Dial **6** **4**.
3. Dial the incoming trunk number (**0** **1** ~ **6** **4**).
4. Press **Feature** (outgoing telephone number is displayed in the LCD). If the outgoing telephone number is longer than nine digits, continue to press **Feature** to display the remaining digits.

SERVICE CONDITIONS

Data Assignment:

- ④ By Class of Service (Attendant) assignment, Attendants are allowed to set or cancel the Automatic Trunk-to-Trunk Transfer feature.
- ④ Automatic Trunk-to-Trunk Transfer must be allowed in System Programming and the CO/PBX providing the outside line must be assigned with Automatic Release.
- ④ An automatic disconnect timer is provided to release an Automatic Trunk-to-Trunk Transfer (default: 1 hour).









Restrictions:

- ④ The outgoing trunks are not available for use when the feature is set.
- ④ Automatic Trunk-to-Trunk Transfer and the Automated Attendant feature cannot be set for the same trunk at the same time.

General:

- ④ When this feature is activated, and an incoming call rings in, any ringing assigned station rings and the call can be answered while the outgoing call is being made.
- ④ The incoming trunk can be a CO/PBX or Tie/DID line.
- ④ The outgoing trunk can be a CO/PBX or Tie line.
- ④ The Attendant can press the Feature key and the line key to verify the Automatic Trunk-to-Trunk Transfer status when set.
- ④ If the outgoing line is in use and an incoming call rings in, the call is treated as a normal incoming call. When the outgoing line becomes free, the Automatic Trunk-to-Trunk Transfer feature is activated.
- ④ When this feature is activated, the incoming trunk LEDs assigned on Multiline Terminals wink and the outgoing trunk LEDs light solid.
- ④ When this feature is activated, the incoming trunks set for Automatic Trunk-to-Trunk Transfer (winking) are available for outgoing use.
- ④ The outgoing telephone number cannot exceed 24 digits.
- ④ After the system dials the outgoing number, the incoming call is transferred, the trunk LED assigned to Line keys lights steady and the call cannot be answered.
- ④ The outgoing trunk circuit must provide a line reversal signal or busy tone (disconnect tone) upon the outside party disconnecting the call. Unless this is provided, the trunks used in the trunk-to-trunk transfer may remain busy until cleared by the automatic disconnect timer.

GUIDE TO FEATURE PROGRAMMING

Order and Shortcut	System Data Name	Memory Block	Function	1-8-07 Attendant Page-Line Key	1-8-08 Station Page-Line Key
 +BCT	* Trunk Incoming Answer Mode Selection	3-05			
 +AT	* Automatic Tandem Trunk Assignment	3-06			
 +BCT	* Trunk-to-Trunk Transfer Yes/No Selection	3-04			
 +BTS	Class of Service (Attendant) Feature Selection 1	1-8-07		1-7	
 +BTT	Station to Class of Service Feature Assignment	4-17			
 +AT	Automatic Tandem Trunk by Night Mode Selection	1-4-05			
 +AT	Tandem Transfer Automatic Disconnect Time Selection	1-4-00			
 +BCT	Automatic Release Signal Detection Selection	3-40			

* When the system is at default this Memory Block **must** be programmed for the feature to be used.

Background Music - Multiline Speaker

B-1

FEATURE DESCRIPTION

Music on hold provides station background music through the station speaker when the station is idle. A COI port can be used as an alternate background music source.

SYSTEM AVAILABILITY

Terminal Type

All Multiline Terminals.

Required Components

None.

OPERATING PROCEDURES

To set Background Music (BGM) when the Multiline Terminal is idle:

1. Press BGM On/Off key (or press **Feature** + **2** **ABC** **6** **MNO**).
2. Background Music is displayed on the Multiline Terminals for five seconds.

To cancel Background Music:

1. Press BGM On/Off key (or press **Feature** + **2** **ABC** **6** **MNO**).
2. The Background Music display is cancelled after five seconds.

SERVICE CONDITIONS



Data Assignment

- ⓘ A COI port may be assigned as the station BGM port in system programming.

General

- ⓘ Background Music stops while the Multiline Terminal is in use.
- ⓘ When Background Music is provided via a COI port, a Batesford Electronics Model No. TIC2F2 Line Isolation Unit (or equivalent) is required to provide Talk Battery to the COI port.
- ⓘ BGM stops at a station that is in DND mode while receiving an incoming call indication.
- ⓘ Call origination, answering a voice announcement, a ringing call, paging, or pressing the Feature key interrupts Background Music.

GUIDE TO FEATURE PROGRAMMING

Order and Shortcut	System Data Name	Memory Block	Function	1-8-07 Attendant Page-Line Key	1-8-08 Station Page-Line Key
 +BCS	BGM Port Assignment	1-1-79			
 +BTS	* Class of Service (Station) Feature Selection 2	1-8-08			4-7
 +BCS	Hold Tone Source Selection	1-8-31			

* When the system is at default this Memory Block **must** be programmed for the feature to be used.

Background Music Over External Speakers

B-2

FEATURE DESCRIPTION

Background music over external speakers is integrated with the three-zone paging system that is provided by the ECR-U() ETU. The connection is extremely easy, and no external relay system is necessary. When a zone (or all zones) is connected to paging, the Paging System BGM is turned off automatically.

SYSTEM AVAILABILITY

Terminal Type
Not applicable.

Required Components
ECR-U() ETU

OPERATING PROCEDURES





Not applicable:

SERVICE CONDITIONS

General

- ⓘ No amplifier is provided on the ECR-U() ETU.
- ⓘ The impedance of the speakers is to be 600Ω .
- ⓘ The Paging BGM input impedance is 600Ω .
- ⓘ The control relays can handle up to 24 Vdc @ 500 mA.
- ⓘ The paging output comes from the ECR-U() ETU to an amplifier (up to 10W) and then back into the ECR-U() ETU. The speakers are connected to the ECR-U() ETU (up to three zones). The ECR-U() ETU does the rest.

GUIDE TO FEATURE PROGRAMMING

Order and Shortcut	System Data Name	Memory Block	Function	1-8-07 Attendant Page-Line Key	1-8-08 Station Page-Line Key
 +BS	Card Interface Slot Assignment	7-1			
 +BP	General Purpose Relay Assignment	1-8-37			
 +BP	External Speaker Connection Selection	1-7-02			
 +BP	External Paging Alert Tone Selection	1-7-03			
 +BP	External Paging Timeout Selection	1-7-06			

FEATURE DESCRIPTION

This programmable feature allows selected Multiline Terminal users in the system to override another station user's conversation with an audible alert to that station user.

SYSTEM AVAILABILITY

Terminal Type





All Multiline Terminals.

Required Components





None.

OPERATING PROCEDURES



To Barge-in using a station number :

1. Lift the handset or press  and receive internal dial tone.
2. Press , then press .
3. Dial the station number to be overridden.
4. Press .
5. Interrupt is enabled.

To Barge-in using an outside line number:

1. Lift the handset or press  and receive internal dial tone.
2. Press , then press .
3. Dial .
4. Dial the CO/PBX number to be overridden.
5. Press .
6. Interrupt is enabled.

To Barge-in using an outside line key:

1. Lift the handset or press  and receive internal dial tone.
2. Press , then press .
3. Press the CO/PBX line key to be interrupted.
4. Interrupt is enabled.

**SERVICE
CONDITIONS****Data Assignment**

- ④ Multiline Terminals, specified in System Programming, can be used to interrupt the privacy status of conversations on outside lines.
- ④ Barge-In can be allowed or disallowed by Class of Service.
- ④ Each Barge-In in progress uses a conference circuit.







Restrictions

- ④ Barge-In is not allowed for internal calls.
- ④ Barge-In is not allowed until the Elapsed Call Timer starts.
- ④ Add-On Conference calls cannot be interrupted.
- ④ The Barge-In feature is not permitted if six Add-On Conferences are in progress.
- ④ The Barge-In feature does not override a conversation of a Private Line.
- ④ A Single Line Telephone user cannot activate Barge-In; however, the conversation on a Single Line Telephone can be interrupted.
- ④ The Barge-In feature cannot be used on outside lines for another tenant unless the lines are assigned to both tenants.
- ④ Data Line Security denies a station from barging in, even if Barge-In is allowed in Class of Service.
- ④ Barge-In is not allowed on outside lines on Hold.

General

- ④ Barge-In overrides a conversation held by a station in Do Not Disturb mode.
- ④ When Barge-In is denied, DENIED is displayed in the LCD.
- ④ The station interrupting an outside line cannot put the CO/PBX call on hold.
- ④ An alert tone is provided to the station user when Barge-In is initiated.
- ④ Each Barge-In in progress uses a conference circuit.

GUIDE TO FEATURE PROGRAMMING

Order and Shortcut	System Data Name	Memory Block	Function	1-8-07 Attendant Page-Line Key	1-8-08 Station Page-Line Key
 +BTS	* Class of Service (Station) Feature Selection 2	1-8-08			1-4, 1-5
 +BTT	* Station to Class of Service Feature Assignment	4-17			
 +BN	Trunk to Tenant Assignment	2-01			
 +BCS	Private Line Assignment	1-1-29			
 +BTT	SLT Data Line Security Assignment	4-90			
 +BTS	Barge-In Alert Tone Assignment	1-1-76			
 +BM	Start time Selection	1-1-05			

* When the system is at default this Memory Block **must** be programmed for the feature to be used.

THIS PAGE INTENTIONALLY LEFT BLANK

Battery Backup - System Memory

B-4

FEATURE DESCRIPTION

A battery is provided on the CPUI()-U() ETU, to retain System Program Memory if power fails. When fully charged, the battery maintains backup power for approximately 21 days. System Data, Speed Dial Memories, and Clock/Calendar are among the functions protected by the backup battery. When power is restored, the system returns to normal operation.

SYSTEM AVAILABILITY

Terminal Type

Not applicable.

Required Components

None.

OPERATING PROCEDURES

Not applicable:

SERVICE CONDITIONS

Restrictions

- ⓘ Battery backup on the CPUI()-U() ETU Unit does not protect the following:
 1. Automatic Callback
 2. Off-line Status (for programming system or station assignments)
 3. Automatic Redial
 4. Trunk Queuing

General

- ⓘ The battery connector on the CPUI()-U() ETU Unit should be disconnected during long term storage but must be connected (protection against loss of power) at the time of installation to provide battery backup for System Memory.
- ⓘ When fully charged, the battery retains System Memory for approximately 21 days.

- ⓘ Battery backup on the CPUI()-U() ETU Unit retains memory for the following functions:
 1. System Program
 2. Night Transfer Status
 3. Call Forwarding
 4. Callback Request
 5. Speed Dial Memories (System/Station)
 6. Clock/Calendar
 7. Do Not Disturb (DND)
 8. Save and Repeat
 9. Store and Repeat
 10. Last Number Redial
 11. Message Waiting
 12. Microphone Status
 13. Station Lock (Set and Password)
 14. Timed Alarm
 15. Customised Message
 16. Voice Mail Message
 17. Feature Access and One-Touch Keys
 18. Volume Set Level
 19. Automatic Attendant Mode
 20. Automatic Trunk-to-Trunk Transfer Mode
 21. General Purpose Relay setting
- ⓘ During normal operation, the batteries are continually recharged via a built-in charging circuit.
- ⓘ The backup battery on the CPUI()-U() ETU should be replaced every 2 years. Refer to the Xen IPK System Hardware manual for further details.

RELATED FEATURES LIST

Feature Number	Feature Name
B-5	Battery Backup - System Power

Battery Backup - System Power

B-5

FEATURE DESCRIPTION

A built-in battery provides complete system operating power for approximately 30 minutes during commercial power outages. If optional locally provided batteries are connected and fully charged, full system operation can be maintained for an extended time. Actual time depends on system configuration, traffic conditions, and the capacity of the batteries being used.

SYSTEM AVAILABILITY

Terminal Type
Not applicable.

Required Components
B64-U() KSU

OPERATING PROCEDURES

Not applicable.

SERVICE CONDITIONS

General

- ⓘ During normal operation, the batteries are continually being recharged via a built-in charging circuit.
- ⓘ The B64-U() KSU is equipped with batteries for system battery backup.

RELATED FEATURES LIST

Feature Number	Feature Name
N/A	N/A

THIS PAGE INTENTIONALLY LEFT BLANK

Busy Lamp Field on Multiline Terminals

B-6

FEATURE DESCRIPTION

The Busy Lamp Field (BLF) feature indicates station status with LEDs. The LEDs light for Feature Access keys and One-Touch keys (when applicable) programmed for Direct Station Selection (DSS). This allows Multiline Terminal users to determine at a glance if a station is in use.

SYSTEM AVAILABILITY

Terminal Type

DTR/DTU-8D-() TEL	Up to 8 line keys
DTR/DTU-16D-() TEL	Up to 8 line keys
DTR-16LD-1A TEL	Up to 16 line keys*
DTR/DTU-32D-() TEL	Up to 16/24 line keys and 16/8 One-Touch keys

* The 16LD telephone indicates BLF status by an LCD indicator.

Required Components





None.

OPERATING PROCEDURES

To program the Feature Access key for DSS/BLF:

1. Press **Feature**.
2. Press **Redial**.
3. Press the Feature Access key.
4. Dial **7**.
5. Dial the station number.
6. Dial **7** (optional step, toggles call between voice and tone).
7. Press **Feature**.

To program the One-Touch key for DSS/BLF:

1. Press .
2. Press .
3. Press the One-Touch key.
4. Dial .
5. Dial the station number.
6. Dial  (optional step, toggles call between voice and tone).
7. Press .



SERVICE CONDITIONS

Data Assignment



-  System Speed Dial (100 mode) must be assigned in System Programming to enable programming line keys as Feature Access keys. The user can then assign Feature Access keys as DSS/BLF keys.

General

-  A single colour LED (red only) is used to indicate the following station status:

LED is Flashing:	Station is in Do Not Disturb (DND) or Call Forward - All Calls, Break Mode.
LED is Winking:	Station is Off-Line (to program). Station is accessing FNC features.
LED On:	Station is busy, receiving Voice Announcement, receiving Internal/DIT/ANA/TIE/DID ringing signal, or was put on hold.
LED Off:	Station is idle, receiving CO/PB call, receiving CO/PBX transferred call, or receiving recall.
-  Local power is not required for the BLF function on a Multiline Terminal. The Attendant Add-On Console requires an AC transformer that is provided with the console.
-  Assignment of One-Touch keys for Direct Station Selection (DSS) with busy lamp indications is programmable by the user from the Multiline Terminal. Any existing station can be assigned.

GUIDE TO FEATURE PROGRAMMING

Order and Shortcut	System Data Name	Memory Block	Function	1-8-07 Attendant Page-Line Key	1-8-08 Station Page-Line Key
 +BE	Speed Dial Buffer Allocation	1-1-35			
 +BTM	Line Key Selection for Telephone Mode	4-12			

THIS PAGE INTENTIONALLY LEFT BLANK

Call Alert Notification

C-1

FEATURE DESCRIPTION

The Call Alert Notification feature allows station users to receive an alert tone, flashing ICM, Large LED, and LCD identification when an incoming caller has called while the user station is busy. This allows the station user to put the current call on hold to answer a second call, increasing call handling abilities.

This feature works with Call Forward BNA so the second incoming call is queued to the station for 8 seconds (default) before the forward is provided.

SYSTEM AVAILABILITY

Terminal Type

All terminals.

Required Components

None.

OPERATING PROCEDURES

To answer an incoming DIT, DID, Tie line, or Automated Attendant transferred call on a Multiline Terminal after receiving a Call Alert Notification, while talking with another party:

1. Press  . The first call is put on hold.
2. Incoming caller is automatically connected.

To answer the incoming call on any station (single-line station in particular) after receiving a Call Alert Notification, while talking with another party:

1. Go on-hook on the first call.
2. Go off-hook to answer the incoming call.

SERVICE CONDITIONS

Data Assignment

- Ⓢ If a station that has Call Forward - Busy assigned receives a second call, this call follows the Call Forward - Busy setting either immediately or after the Call Forward - No Answer timer has expired.
- Ⓢ When Data Line Security is assigned to a Multiline Terminal that allows Call Alert Notification in Class of Service, the tone is heard only through the speaker of the Multiline Terminal.

Restrictions





- ④ If a station that has set DND receives a second call, no Call Alert Notification tone is provided.
- ④ A station does not receive Call Alert Notification if the Automatic Redial feature is activated.

General

- ④ This feature is provided for DID, DIT, Tie line, internal transferred calls, and Automated Attendant transferred calls.
- ④ If an Automated Attendant transferred call does not get answered and changes to a normal CO ringing, the Call Alert Notification is no longer provided at the station receiving the transferred call.
- ④ If a station that has Call Forward - No Answer assigned receives a second call, this call follows the Call Forward - No Answer timer before it is forwarded.
- ④ If a station is already receiving a Call Alert Notification, an additional internal call to this station provides Busy tone to the caller. If Call Forward - Busy was set, the internal call follows this forward setting.
- ④ Incoming Call Alert Notification to Multiline Terminals is as follows:
 - ICM and Large LED flash.
 - LCD shows second incoming call.
 - A Call Alert Notification tone of 0.8 seconds is provided to the called party.
- ④ There is no LCD indication to show a second call is ringing in when using the Store and Repeat feature.
- ④ Incoming Call Alert Notification to Single Line Telephones is as follows:
 - A Call Alert Notification tone of 0.8 seconds is provided to the called party.
- ④ The calling party hears the following when the called station is already on another call:
 - Automated Attendant, DIT, DID, and Tie line callers hear ringback tone.
 - Internal callers hear call waiting, allowing Step Calling to be used.
- ④ If a station is the Master Hunt Number for a Station Hunt group, the second call follows the Station Hunt Group assignment. If all agents in this group are busy, then Call Alert Notification is given to the called party and the call remains at the master station.
- ④ Multiple incoming calls, except internal and Automated Attendant transferred calls, continue to ring at a station that is busy. However, the LCD of this station only indicates the first call waiting to be answered.
- ④ ACD agents who are busy on a call do not receive Call Alert Notification if another ACD call is received, Call Alert Notification is provided if a call is transferred to the station and not the pilot.

- ④ The following are the maximum incoming calls that can wait at a station:
 - DIT, DID, and Tie lines:
No Limitation
 - Internal and Automated Attendant transferred calls:
No Limitation
- ④ Calls in the Call Alert Notification condition cannot be answered using Call Pickup.

GUIDE TO FEATURE PROGRAMMING

Order and Shortcut	System Data Name	Memory Block	Function	1-8-07 Attendant Page-Line Key	1-8-08 Station Page-Line Key
 +BTS	* Class of Service (Station) Feature Selection 2	1-8-08			3-8
 +BTT	Station to Class of Service Feature Assignment	4-17			
 +BTT	Call Forward - Busy Immediately/Delay Selection	4-42			
 +BTT	SLT Data Line Security Assignment	4-90			
 +BM	Call Forward - No Answer Time Selection	1-2-22			

* When the system is at default this Memory Block **must** be programmed for the feature to be used.

THIS PAGE INTENTIONALLY LEFT BLANK

Call Appearance Keys (CAP)

C-2

FEATURE DESCRIPTION

The Call Appearance key feature automatically places an outside call onto a Call Appearance key when the system is operated as a hybrid (multifunction) system. These keys can be assigned on any Multiline Terminal or the same key can appear on multiple terminals. This feature allows efficient call handling when numerous CO calls are received, but a limited number of CO line appearances are available. These keys are often called CO loop keys.

SYSTEM AVAILABILITY

Terminal Type



All Multiline Terminals.

Required Components



None.

OPERATING PROCEDURES

To place a Multiline Terminal outgoing call on hold and retrieve it:

1. Go off-hook using the handset or press . Receive internal dial tone.
2. Dial Trunk Access Code (default: ). A Call Appearance key lights.
3. Dial the outside party, and begin conversation.
4. Press . The Call Appearance key flashes.
5. Press the flashing Call Appearance key to retrieve the call.

To place a Multiline Terminal incoming call on hold and retrieve it:

1. Receive CO/PBX incoming ring.
2. Go off-hook using the handset, or press . A Call Appearance key lights. Talk with outside party.
3. Press . The Call Appearance key flashes.
4. Press the flashing Call Appearance key to retrieve the call.

SERVICE CONDITIONS

Restrictions

- Ⓢ A conference call involving two outside lines cannot reside on one Call Appearance key.





General

- Ⓢ When a trunk call is originated or answered at a Multiline Terminal, it must appear on a line key. The line key can be assigned as the trunk itself or as a Call Appearance Key. A Call Appearance Key is dynamic because a CAP key is used for any trunk call a multiline terminal is using. An 8-key multiline terminal can have eight CAP keys that allow the telephone to process all 64 trunks, 8 trunks at a time.
- Ⓢ The Xen IPK system selects trunks from last trunk to the first within a trunk group. Trunk Access Code (default: ①) will not work if no CAP or trunk appearance on the MLT. This occurs at default systems with more than 8 trunks.
- Ⓢ There are 1152 different CAP keys that are broken up into 48 CAP blocks with 24 keys per block. In system programming, a Multiline Terminal is associated with a single CAP block. As the Multiline Terminal processes calls, only keys in its assigned CAP block are used.
- Ⓢ Several Multiline Terminals can be assigned to the same CAP block with the same set of 24 keys. Incoming trunks to these Multiline Terminals appear on the same CAP key at each station.
- Ⓢ Call Arrival keys can also be associated with a CAP block. As calls arrive and are answered from a CAR, they will move to the assigned CAP keys on the terminal. Different CAR keys can be associated with different CAP blocks to segregate calls based on the extension the call was sent to. In addition if a CAR is not assigned to a CAP block, then the telephone CAP assignment is used by the CAR.
- Ⓢ Any held call left on a Call Appearance key for more than the programmed time interval recalls to the Multiline Terminal where the call was originally put on hold.
- Ⓢ If a Multiline Terminal (other than the one that originally initiated or received a call) is used to retrieve a held call, the SMDR records a transfer to the Multiline Terminal where the call was retrieved.
- Ⓢ Only outside lines use a Call Appearance key.
- Ⓢ Outside lines reside on the Call Appearance key in the order of lowest to highest line key numbers on the station.
- Ⓢ A Multiline Terminal can have multiple Call Appearance keys assigned to it (including those from different Call Appearance blocks).
- Ⓢ All Flexible Line keys on a Multiline Terminal can be assigned as Call Appearance keys in System Programming.
- Ⓢ Multiline Terminals and Call Arrival Keys are assigned to Call Appearance blocks in System Programming.

RELATED FEATURES LIST

Feature Number	Feature Name
C-3	Call Arrival Keys (CAR)

GUIDE TO FEATURE PROGRAMMING

Order and Shortcut	System Data Name	Memory Block	Function	1-8-07 Attendant Page-Line Key	1-8-08 Station Page-Line Key
 +BN	Line Key Selection	2-05			
 +BN	Line Key Selection for Tenant Mode	2-06			
 +BTT	* Station to Call Appearance Block Assignment	4-43			
 +BTM	* Line Key Selection for Telephone Mode	4-12			

* When the system is at default this Memory Block **must** be programmed for the feature to be used.

THIS PAGE INTENTIONALLY LEFT BLANK

Call Arrival Keys (CAR)

C-3

FEATURE DESCRIPTION

Call Arrival keys (CARs) are software extensions available as part of the 120 possible station numbers for the Xen IPK Expanded system. The IPK Basic system provides 40 CARs in addition to the 32 possible station numbers. A Call Arrival extension that is assigned to a line key, can appear and ring on an individual station or multiple stations. When a call is directed to a CAR, any station with the CAR can answer that call. This ensures that every call to that group is answered promptly. A Multiline Terminal/Terminals may have several CAR extension appearances depending on the application.

SYSTEM AVAILABILITY

Terminal Type

All Multiline Terminals.

Required Components

None.

OPERATING PROCEDURES

To answer an incoming outside call to the Call Arrival key while on an outside or internal line call with Off-Hook Ringing assigned:

1. Receive off-hook ringing.
2. Press . The first call is placed on hold, and the CAR is answered.
3. The incoming call resides on a Call Appearance key, or CO Line key if it is assigned on the telephone.

To answer an incoming outside line call to the Call Arrival key while on an internal call with Ringing Line Preference:











1. Go on-hook on an internal call.
2. Go off-hook to answer incoming outside line call to a Call Arrival key.

SERVICE CONDITIONS

Restrictions

- ④ Call Arrival extensions use system extension numbers that are assigned in groups of four.
- ④ Xen IPK Basic system can contain up to 64 Call Arrival Keys, 24 of these sharing the maximum of 32 station ports.

GUIDE TO FEATURE PROGRAMMING

Order and Shortcut	System Data Name	Memory Block	Function	1-8-07 Attendant Page-Line Key	1-8-08 Station Page-Line Key
 +BK	* Call Arrival Key Block Assignment	1-2-04			
 +BN	Line Key Selection for Tenant Mode	2-06			
 +BA	Access Code (1- or 2-Digit) Assignment	1-1-46/47/48	001		
 +BS	* Station Number Assignment	4-10			
 +BTM	* Line Key Selection for Telephone Mode	4-12			
 +BTM	* Extension Line Key Ring Assignment (Day Mode)	4-37			
 +BTM	* Extension Line Key Ring Assignment (Night Mode)	4-38			
 +BTD	Attendant Add-On Console Key Selection	1-6-05			
 +BTM	SIE/CAR Ringing Line Preference Selection	4-41			
 +BTT	Station to Call Appearance Block Assignment	4-43			

* When the system is at default this Memory Block **must** be programmed for the feature to be used.

- ④ The Xen IPK Expanded system can contain up to 112 Call Arrival keys. This number is shared with a maximum of 120 station ports. If 112 CARs are assigned, the remaining eight numbers can be assigned for hardware extension numbers.
- ④ Call Arrival keys are likely assigned to a Call Appearance block in System Programming. Read the Call Appearance Key features and specifications because CAR and CAP can be closely related.
- ④ Call Forward cannot be set on a CAR key that has a station number of 00,000, or 0000.

General

- ④ Incoming outside line calls can ring on a CAR. When the call is answered, it resides on a CAP. The CAR becomes idle for another incoming call or it continues to flash indicating that another call is waiting to be answered. If no Call Appearance key (or CO Line key) is available, an outside line call to a Call Arrival key cannot be answered.
- ④ Incoming internal calls to a Call Arrival key can be answered with no Call Appearance key assigned. The ICM lamp (if provided) indicates a call, and if the call is put on hold, flashes at the Conf key.

- ④ Go off-hook, press the Speaker key if Ringing Line Preference is assigned, press the flashing Call Arrival key, or press the Answer key to answer Calls ringing into a Call Arrival key.
- ④ Call Arrival Keys can be set for Call Forward-All Calls and Call Forward-Busy/No Answer.
- ④ Call Arrival keys can be set for Call Forward - Off Premise.
- ④ Off-Hook Ringing can be provided for calls ringing into Call Arrival keys.
- ④ Call Arrival keys can be assigned as a station hunting master number and/or as members of a Station Hunt group.
- ④ A BLF indication is provided on an Attendant Add-On Console for incoming calls.
- ④ A Call Arrival key can be used as a DSS key from an Attendant Add-On Console or as a DSS key at a Multiline station.
- ④ An internal call to a Call Arrival key is ring only. (Voice announce is not available).
- ④ CO calls that are transferred to a CAR key are not answered on a First in First Out basis.
- ④ DID/Intercom calls to a CAR key have priority over CO transferred calls to the same CAR key.

RELATED FEATURES LIST

Feature Number	Feature Name
C-2	Call Appearance Keys (CAP)

THIS PAGE INTENTIONALLY LEFT BLANK

Callback Request

C-4

FEATURE DESCRIPTION

A Callback Request can be set to any Multiline Terminal to notify the user that another station wants a call returned. Users of Multiline Terminals can receive a maximum of three Callback Requests from other station users. Non-display Multiline Terminal users receive a Feature LED indication when a Callback Request is set. Single Line Telephone users can set but not receive a Callback Request.

SYSTEM AVAILABILITY

Terminal Type

All Multiline Terminals.

Required Components

None.

OPERATING PROCEDURES

To set from a station while placing an internal call and receiving Call Waiting or No Answer:

1. Dial Access Code $\#$.
2. Hang up.

To cancel from the originating station:

Dial the destination where the Callback Request is set.

To cancel from an Attendant Position (system-wide):

1. Press Feature . Requires class of service 1-8-07 to be enabled.
2. Dial 8 TUV 8 TUV .
3. Press Feature .

Note: At default, this ability is denied. Requires class of service in MB 1-8-07 to be enabled.

To Callback from a Multiline Terminal with LCD:

1. Press  or lift the handset.
2. Dial the number to be called back, or assigned access code (not set in default).
3. Lift the handset to talk when the party answers.
4. Hang up.

To Callback from a Multiline Terminal with or without LCD:



1. Press  or lift the handset.
2. Dial assigned access code (not set in default).
3. Lift the handset to talk.
4. Hang up.

**SERVICE
CONDITIONS****General**

- ④ All stations can be used to set a Callback Request. A Callback Request can be set to one or more Multiline Terminals regardless of tenant assignment.
- ④ Multiline Terminals without displays receive an indication of the Callback Request by a flashing Feature LED that flashes 0.25 seconds On, 0.25 seconds Off.
- ④ If a Multiline Terminal receives two or more Callback Requests, they are called back in the order they were received.
- ④ A maximum of three Callback Requests can be set at one Multiline Terminal.
- ④ Callback Requests are protected by system memory battery backup.
- ④ A caller does not receive a set tone when attempting to leave a Callback Request at a station where three Callback Requests are set. When a Callback Request is set, the caller receives a set tone.
- ④ Callback Requests that are set in the system can be cancelled (system-wide) only at Attendant Positions.
- ④ Individual Callback Requests are cancelled by:
 1. Callback recipient places internal call to Callback originator.
 2. Callback originator places internal call to Callback recipient.
 3. Callback recipient enters Feature, 99, Feature.

- ④ A Callback Request can be set to a Single Line Telephone (SLT), but there is no indication at the SLT. The SLT can still go Off-hook and dial # to complete the callback.
- ④ To use Access Code #, this must be changed from function 096 to 026 in System Programming.

GUIDE TO FEATURE PROGRAMMING

Order and Shortcut	System Data Name	Memory Block	Function	1-8-07 Attendant Page-Line Key	1-8-08 Station Page-Line Key
 +BA	Intercom Feature Access Code Assignment	1-2-24	005		
 +BTS	Class of Service (Station) Feature Selection 2	1-8-08			2-2
 +BTT	Station to Class of Service Feature Assignment	4-17			

THIS PAGE INTENTIONALLY LEFT BLANK

Caller ID Call Return

C-5

FEATURE DESCRIPTION

The Caller ID Call Return feature allows the voice mail system to use Caller ID information captured with the message to call and connect the person that left the message with the voice mail user that is checking messages. After the call is ended by either party, the voice mail user returns to checking messages.

SYSTEM AVAILABILITY

Terminal Type:

All Multiline terminals and Single Line telephones.

Required Components:

VMS(2)/(4)/(8)-U() ETU or FMS(2)/(4)-U() ETU.

OPERATING PROCEDURES

Caller ID Information Operation on non-display Multiline telephone or Single Line telephone:

1. Dial the XenMail extension.
2. After message playback, XenMail prompts to hear Caller ID number only.



- OR -

Dial  during message to stop playback, save the current message as an old message, and hear Caller ID number only.

3. When Caller ID information is available after the Caller ID number is played, the system prompts the mailbox user with an option to return the call.

- OR -

During message playback dial  .

Note: To repeat the Caller ID number during its playback, dial . To skip to the end of the Caller ID number dial .

4. To end a Return Call, dial    to return to the mailbox and disconnect the outside call.

Caller ID Information Operation on display telephone with Softkeys:

1. Dial the XenMail extension.
2. During message playback, XenMail displays Caller ID name and/or number only depending on system programming. To change display between Name and Number, press Δ (MORE) Softkey twice then press Δ (CID) Softkey.

- OR -

Dial $\textcircled{0}$ during message to stop playback, save the current message as an old message, and hear Caller ID number only.

Note: When $\textcircled{0}$ is dialled, you can dial $\textcircled{\#}$ to repeat the Caller ID number or dial $\textcircled{*}$ to skip to the end of the number.

3. During playback, using a mailbox that allows the option, press the Δ (MORE) Softkey three times then press the Δ (CALL) Softkey to return the call.
4. To end a Return Call, press the Δ (END) Softkey to return to the mailbox and disconnect the outside call.

Caller ID Information operation from telephone outside the system:

1. Call the number that takes you to the main greeting of the XenMail system.
2. While main greeting is playing, dial $\textcircled{9}$, by default, and your extension to take you to the mailbox. Enter security code if prompted.
3. Follow prompts to listen to new, old, or archived voice mail messages.
4. When Caller ID information is available, XenMail prompts to hear Caller ID number only after message playback.

- OR -

Dial $\textcircled{0}$ during message to stop playback, save the current message as an old message, and hear Caller ID number only.

5. When Caller ID information is available, the system prompts the mailbox user with an option to return the call after the Caller ID number is played.

- OR -

During message playback dial $\textcircled{\#}$ $\textcircled{0}$,

Note: To repeat the Caller ID number during playback, dial $\textcircled{\#}$. To skip to the end of the Caller ID number dial $\textcircled{*}$.

6. To end a Return Call, dial $\textcircled{\#}$ $\textcircled{0}$ $\textcircled{*}$ to return to the mailbox and disconnect the outside call.

SERVICE CONDITIONS

Data Assignment:

- ④ Use Memory Block 1-8-08 [Class of Service (Station) Feature Selection] Page 4, LK3 to allow (LED On) or Deny (default: LED Off) capture of Caller ID information on voice mail ports.
- ④ The Return Call feature can be enabled per mailbox in Expanded Access Codes and can be enabled for internal numbers only or for both internal and external numbers.
- ④ To use this feature for long distance calls, LCR or ACR must be programmed for the voice mail ports set to dial out. Refer to Chapter 2 in the Xen IPK System Programming Manual for detailed programming instructions.
- ④ The enhanced Caller ID is enabled by setting CID=0,0 on the Integration Options line of Easymade Switch Setup Screen, Page 1. When Caller ID is already enabled on a system that is updated, the CID=X,Y setting can be changed to CID=0,0. Only one CID setting is allowed on this line.
- ④ The Return Call parameter must be entered on the Integration Options line of Easymade Switch Setup Screen, Page 1 to enable this voice mail feature. Default is RCV=6,10 where 6 is the number of rings voice mail tries when returning a call, and 10 is the number of minutes a returned call can last.
- ④ A trunk access code must be entered on Easymade Switch Setup Screen, Page 1, line 9 so the Return Call feature can access a trunk to return the call. When this is not entered, the mailbox user is not prompted to return the call even when Caller ID information is available.
- ④ The Rings to answer field on Easymade Applications Screen, Page 2, line 15 must be set to 2 or greater because Caller ID information is provided from Telco between the first and second ring.

















Restrictions:

- ④ VMS revision 01031 v 6.68 and FMS revision 06231 v 6.68 or higher are also required.
- ④ When Centralised Voice Mail is used, the remote voice mail user gets only Caller ID number when voice mail answers incoming CO calls and performs an Await-Answer transfer to the remote user. A Call that forwards to voice mail from the remote system does not have Caller ID information.
- ④ Live Record is not available when using Return Call.
- ④ A Telephone used as an ACD Plus agent or supervisor station should not have mailboxes that support Softkeys. Softkeys can be disabled per mailbox in Access Codes Options on Easymade Application Screen, Page 5 of 6. Place an * in front of Hands Free Play (Item N) to disable Softkeys for a particular station.

General:

- ④ A caller using a telephone without Softkeys, calling from outside the system, or from a remote system is prompted to hear Caller ID information and return a call.
- ④ Return Call is available for subscriber messages and public messages.
- ④ Return Call is accessible to a subscriber during and after message playback.
- ④ Return Call is available for new and old messages.
- ④ Return Call is accessible to a subscriber using Softkeys in Softkey mode or using DTMF in voice conversation Mode.
- ④ One minute before disconnecting the original caller, voice mail plays a warning prompt and immediately before disconnecting plays a prompt to indicate that it is returning to the subscriber mailbox.
- ④ When a subscriber listens to a message from a Softkey equipped telephone, and Caller ID information is unavailable, the voice mail system leaves the second line of the LCD blank. When Caller ID is disabled on the system, voice mail displays the message count.
- ④ From the subscriber options Softkey menu, a subscriber can access a Softkey menu that allows selection of name or number to be displayed on the LCD during message playback. The default is number. Voice mail uses this setting to determine the initial display on the LCD during playback.
- ④ Voice mail continues to display Caller ID on the LCD while the post-message playback menu is still displayed on a telephone equipped with Softkeys.
- ④ During Return Call, the voice mail port is in conference with the box owner and messages.
- ④ Internal station terminals using Call Return have the Conf key LED On.

GUIDE TO FEATURE PROGRAMMING

Order and Shortcut	System Data Name	Memory Block	Function	1-8-07 Attendant Page-Line Key	1-8-08 Station Page-Line Key
 +BS	Card Interface Slot Assignment	7-1			
 +BS	MIF (ANI/Caller ID) Assignment	7-3-04			
 +AI	Caller ID Display Assignment for System Mode	1-1-78			
 +BTS	* Class of Service (Station) Feature Selection 2	1-8-08			4-3, 4-4, 5-7, 6-5
 +BCT	DIT Assignment	3-42			
 +BCT	ANA Assignment	3-43			
 +AI	Caller ID Display Assignment for CO/PBX Line	3-44			
 +AI	Caller Name Indication Selection	3-53			
 +BTT	CO/PBX Ring Assignment (Day Mode)	4-01			
 +BTT	CO/PBX Ring Assignment (Night Mode)	4-02			
 +BTM	Line Key Selection for Telephone Mode	4-12			
 +BTT	Station to Class of Service Feature Assignment	4-17			
 +BTM	Extension Line Key Ring Assignment (Day Mode)	4-37			
 +BTM	Extension Line Key Ring Assignment (Night Mode)	4-38			
 +AI	Caller ID Preset Dial Outgoing CO Selection	4-44			
 +AI	Caller ID Display for CAR Key Assignment	4-49			

* When the system is at default this Memory Block **must** be programmed for the feature to be used.

THIS PAGE INTENTIONALLY LEFT BLANK

Caller ID - Incoming

C-6

FEATURE DESCRIPTION

Caller ID displays the calling party telephone number and/or name on the LCD of the Multiline Terminal for CO incoming calls. Up to 16 Multiline Terminals that have CO ringing and/or CAR appearance assigned can automatically display Caller ID information during an incoming call. Multiline Terminals that are not part of these 16 terminals can display Caller ID if they have the appropriate class of service by manual operation. After the CO call has been answered the Caller ID information will follow the call wherever it is transferred to.

SYSTEM AVAILABILITY

Terminal Type

All Multiline Terminals with an LCD.

Required Components

COID(4)-U() ETU, COID(8)-U() ETU, BRT(4)-U() ETU, or PRT(1)-U() ETU to receive Caller ID indication from a central office.

MIFM-U() ETU with KMM()UA installed when Caller ID Scrolling or Call Return are desired.

OPERATING PROCEDURES

To display a stored Caller ID:

Press the Scroll/Directory to display the last incoming Caller ID. Repeatedly press the Scroll/Directory to display additional Caller ID names/numbers. (A maximum of 50 Caller ID names/numbers are displayed.)

-  The Scroll key is programmed in System Programming using the Line Key Selection for the Telephone Mode Memory Block. Refer to the IPK System Programming Manual for instructions.

To return a call to the name/number displayed on the LCD:

Go off-hook. The system automatically accesses an outside line and dials the ID number displayed on the LCD.

Manual Operation:

For Multiline Terminals without automatic Caller ID display but which have an appropriate class of service assigned, the following key sequences will also display Caller ID indication: Feature key + CO key, Feature key + CAR key, or Feature key + Answer key.

SERVICE CONDITIONS

Data Assignment:

Caller ID Indication (Analogue Trunks)

- ④ Use Memory Block 7-1 (Card Interface Slot Assignment) to specify the COID(4)-U(), COID(8)-U(), COID(4)-U() or MIFM-U() ETU.
- ④ Use Memory Block 1-1-78 (Caller ID Display Assignment for System Mode) to assign up to 15 Multiline Display Terminals to display Caller ID indication for incoming calls.
- ④ Use Memory Block 4-49 (Caller ID Display for CAR Key Assignment) to assign one Multiline Terminal per CAR Key to display Caller ID indication for incoming calls.
- ④ Use Memory Block 3-44 (Caller ID Display Assignment for CO/PBX Line) to assign the Caller ID Display for normal incoming CO/PBX calls.
- ④ Use Memory Block 3-71 (Caller Name Display Assignment) to specify whether the network name or speed dial name match is to be displayed.
- ④ Use Memory Block 1-8-08 [Class of Service (Station) Feature Selection 2] Page 4 LK3 to Allow (LED On) or Deny (default: LED Off) Caller ID.
- ④ Use Memory Block 1-8-08 [Class of Service (Station) Feature Selection 2] Page 4 LK4 to Allow (LED On) Caller ID Number display or Deny (default: LED Off) to display the Caller ID Name, when Name and Number are received.
- ④ Use Memory Block 1-8-08 [Class of Service (Station) Feature Selection 2] Page 5 LK7 to Allow (LED On) or Deny (default: LED Off) to display on two rows of the MLT. Both the name and number must be received from the network. Page 4 LK4 selects the position of the name or number on the Display for stations assigned to the Class of Service. When Page 4 LK4 is On, the number is displayed on the top line of the display. When Page 4 LK4 is Off, the name is displayed on the top line of the display.
- ④ Use Memory Block 4-17 (Station to Class of Service Feature Assignment) to make each station Class of Service Assignment.
- ④ Use Memory Block 4-01 [CO/PBX Ring Assignment (Day Mode)] or 4-02 [CO/PBX Ring Assignment (Night Mode)] to make the CO/PBX ringing assignments.

- ④ Use Memory Block 3-53 (Caller Name Indication Selection) to allow the name (NAM) (default: NUM) to be displayed When system speed dial buffers are assigned number and name and when the Caller ID number information matches an assigned speed dial number.
- ④ When the name is not included in the Caller ID information, Memory Block 3-53 (Caller Name Indication Selection) compares the Caller ID information with the dial data in the speed dial area. When the numbers match, the name in the speed dial area is used as the name.
- ④ When a CAR key is assigned on the Multiline Terminal and a DIT/ANA or VRS/Automated Attendant transferred call is received at the CAR, the following assignments are required:
 - Use Memory Block 4-41 (SIE/CAR Ringing Line Preference Selection) to specify whether to allow (default: YS) or deny (NO) Ringing Line Preference (go off-hook or press speaker key) on all telephones that are assigned to CAR keys.
 - Assign the Multiline Terminal with the CAR key as part of the Caller ID group.

Scrolling Caller ID with Return Call

- ④ Use Memory Block 7-3-04 [MIF (Caller ID) Assignment) to specify Scrolling and/or Out Dial function to the MIFM-U() ETU with KMM()UA Unit.
- ④ Use Memory Block 4-44 (Caller ID Preset Dial Outgoing CO Selection) to assign the Trunk Group, Route Advance Group, or Closed Numbering Group that is seized for Caller ID Outgoing Calls.
- ④ Use Memory Block 4-12 (Line Key Selection for Telephone Mode) to assign the Scroll Key to a line key for each Multiline Terminal using the Scroll Feature.

Restrictions

- ④ To receive Caller ID Indication, the COID(4)/(8)-U() ETU, BRT(4)-U() ETU or PRT(1)-U() ETU must be installed.
- ④ SIE incoming calls do not support Caller ID Indication even when the Multiline Terminal is ringing.
- ④ The user can press the Feature key and then the flashing red CO line key (incoming CO call), CAR key or  key to display Caller ID.
- ④ A maximum of 16 stations can display Caller ID. - Five users can access the Scroll function at the same time. IN USE is displayed on the Multiline terminal of another user that tries to access it.
- ④ A maximum of 13 characters can be displayed on the LCD for Caller ID Name/Number.
- ④ Caller ID scrolling and automatic dial out features require installation of the MIFM-U() ETU with attached KMM()UA Unit.

- ④ When a call transferred to a station goes unanswered and is transferred again, Caller ID information is not stored in the scrolling bin at that station.
- ④ Due to variations in the caller ID information received from the network, Display Number/Call Back Number may not function as described in New Zealand.

General:

Caller ID Indication (Analogue Trunks)

- ④ When the CO line key, CAR key or ANSWER key is flashing red (Incoming CO call), the user can press Feature + Key to display Caller ID even when Caller ID is not normally displayed.
- ④ When the telephone company sends the caller name and number, the name or the number is displayed on the LCD while the Multiline Terminal is ringing. When the telephone company sends the caller number only, it is displayed on the top line of the LCD while the Multiline Terminal is ringing.
- ④ A maximum of 15 Multiline Terminals can be assigned to display Caller ID for normal incoming CO calls system-wide. A sixteenth Multiline Terminal can be assigned to display Caller ID for normal incoming CO calls per CO line. These 16 Multiline Terminals constitute a Caller ID group. An answered call can be transferred to any station in the system, and Caller ID is displayed at that station.
- ④ Press the green line key where the CO call resides during a CO call, to verify the Caller ID. When the telephone company provides both Name and Number (depending on the system assignment) they are displayed for 5 seconds, followed by the remaining information.
- ④ When the telephone company sends the caller name and number, the name or the number is displayed on the LCD while the Multiline Terminal is ringing. When the telephone company sends the caller number only, it is displayed on the top line of the LCD while the Multiline Terminal is ringing.
- ④ When system speed dial buffers are assigned number and name, the name can be displayed when the Caller ID number information matches a speed dial number. This is only applicable for the first 100 (000 - 099) system speed dials when the system has been set to 1000 speed dials and first 80 (00 to 79) when the system has been set to 100 system speed dials. Memory Block 3-53, Caller ID Name Indication assignment is used to allow this.
- ④ Caller ID Speed Dial matching will not take place if the speed dial number is incorrectly entered e.g., missing the Area Code.
- ④ A caller ID name matched from a system speed dial buffer will be displayed in preference to a caller ID name received from the network.

- ④ When a Multiline Terminal is busy, the Caller ID is displayed for an incoming call.
- ④ When a Multiline Terminal is set for Do Not Disturb, the Caller ID is displayed for incoming calls.
- ④ When a Multiline Terminal receives multiple incoming calls, the first Caller ID is displayed. After the first call is answered, the second Caller ID is displayed.
- ④ The Caller ID Indication disappears:
 - When an incoming call is answered.
 - When an internal or ring transfer call is received.
 - When Feature Access, DSS, Redial, or Feature key is pressed.
- ④ The Caller ID number is printed on the SMDR printout for incoming calls that are answered at stations that can display Caller ID data. The name is not printed.
- ④ When a station is engaged in a voice over, whisper page, or broker's call, the station can display Caller ID until the process ends.
- ④ When an incoming call is answered before Caller ID is sent, the Caller ID is not displayed.
- ④ The following incoming calls display Caller ID on a Multiline terminal:
 - Ordinary CO Calls
 - DIT/ANA calls
 - VRS/AA calls
 - Ring Transfer calls
 - CAR calls
 - ACD/UCD calls
 - Calls with delayed ringing
- ④ When a Multiline Terminal displays Caller ID with off hook ringing and receives another incoming CO call, the Caller ID changes to the second caller.
- ④ When trunk name indication is assigned, the data in Memory Block 3-00 (Trunk Name/Number Assignment) is displayed on the Multiline Terminal assigned for Caller ID indication even when a terminal receives a caller name and number.
- ④ When hotline/prime line is set in Memory Block 4-23 (Prime Line/Hot Line Assignment), a station user can originate an outgoing call using Caller ID.

Scrolling Caller ID with Return Call

- ④ When the Scroll key is used, a maximum of 50 Caller IDs can be stored in System Memory. When 50 Caller IDs are stored and an additional call is answered, the first Caller ID is erased from System Memory. Press the Scroll key to display the stored Caller IDs. When you go Off-hook, the displayed Caller ID is automatically dialed.
- ④ When Scroll key is not pressed with five seconds of the last press, the LCD returns to idle, and Caller ID disappears.
- ④ The DIR (directory) key provided with the Dterm Series i Terminals performs the same function as the Caller ID Scroll Key.
- ④ When an outgoing call is made using the Scroll function, the call follows Code Restriction, Digit Restriction, and Least Cost Routing (LCR) or Automatic Carrier Routing (ACR). The LCR or ACR feature is required for the Scroll function to operate properly.
- ④ Caller ID data is not stored when the following conditions apply:
 - **Mobile** Call from a Mobile Telephone.
 - **Pay Phone** Caller ID is sent from a pay phone.
 - **Out of Area** Data is sent from a CO that cannot process Caller ID data.
 - **Private** Calling party disables Caller ID information for the called party.
 - **Data Error** The data stream includes an error.
- ④ When **Out of Area** or **Private** characters are received, the MIFM-U() ETU does not store them in the Scroll Key buffer.

RELATED FEATURES LIST

Feature Number	Feature Name
A-22	Automatic Carrier Routing
C-17	Class of Service
D-14	Do Not Disturb (DND)
I-7	ISDN-BRI Trunk Connections
I-8	ISDN-PRI Trunk Connections
L-3	Least Cost Routing (LCR)

Caller ID - Outgoing

C-7

FEATURE DESCRIPTION

This feature allows extensions to present a specific Caller ID number to the called party via the ISDN network. This number is assigned per extension in system programming and identifies the specific extension which is making the call, rather than presenting the group number of the ISDN trunk on which the call is made. This number should generally fall within the allocated DID number range of the ISDN service and is authenticated by the network before being passing onto the called party. This facility applies to ISDN trunks assigned as DID only and may be network dependant.

SYSTEM AVAILABILITY

Terminal Type

All terminals.

Required Components

PRT(1)-U() ETU

BRT(4)-U() ETU

CLKG()-U() Unit

OPERATING PROCEDURES

None.

SERVICE CONDITIONS

Data Assignment

- ④ Use Memory Block 3-91 (Trunk Type Selection) to specify the BRI or PRI ISDN trunks as type 'DID'.
- ④ Use Memory Block 4-47 (ISDN Directory Number Selection) to specify whether or not the station is allowed to present the assigned number in Memory Block 4-62 to the network for Caller ID information when trunks are assigned as DID in Memory Block 3-91.
- ④ Use Memory Block 4-62 (ISDN-PRI Directory Number Selection) to provide individual stations with the 10-digit number to be presented to the ISDN Network when trunks are assigned as DID in Memory Block 3-91. User provided Call screening and presentation may or may not be needed from the ISDN provider. The area code must always be included, even for local numbers, minus the leading '0'. (e.g. 03 (X=0~9) must be entered as 3XXXXXXXX).

General

- ④ ISDN (PRT or BRT) trunk types must be assigned as DID in Memory Block 3-91 for Memory Block 4-62 to provide the number to the ISDN Network.
- ④ A maximum of 13 digits may be entered as the extension-based outgoing caller ID number. This is assigned per station in system programming.
- ④ Caller ID numbers sent to the ISDN network are authenticated by the network ensuring they are within the assigned initial range of that ISDN service. If it is not then the Group Directory Number (GDN) will be inserted by the network instead.
- ④ This feature allows for multiple PRT's or a mix of PRT and BRT services, but care must be taken when specifying the outgoing DID trunk for an extension. The associated caller ID number must be within the initial range of the ISDN service selected.
- ④ When using the feature "Code Restriction Password Override", the extension-based outgoing Caller ID generated will be the number associated with the station from where the call is being made and not the station whose ID/Password has been entered.
- ④ When Memory block 4-47 is assigned as YES, and Memory Block 4-62 has a number assigned, the setting in Memory Block 4-62 overrides the number set in Memory Block 3-52 when the station places an outgoing call using an ISDN service.
- ④ If 'CO' is assigned in Memory Block 3-91, or Memory Block 4-62 is left unassigned, the number stored in Memory Block 3-52 (ISDN Trunk Directory Number Assignment) will be presented as the outgoing Caller ID. If Memory Block 3-52 is also unassigned, the ISDN network will insert the Group Directory Number for that interface.
- ④ For ICM calls to a station with Call Forward Off-Premise set, the outgoing trunk call will present the CLI assigned in MB 4-62 of the station initiating the ICM call. For DID/DIT calls to a station with Call Forward Off-Premise set, the outgoing trunk which was seized, or the network GDN if this is not programmed.

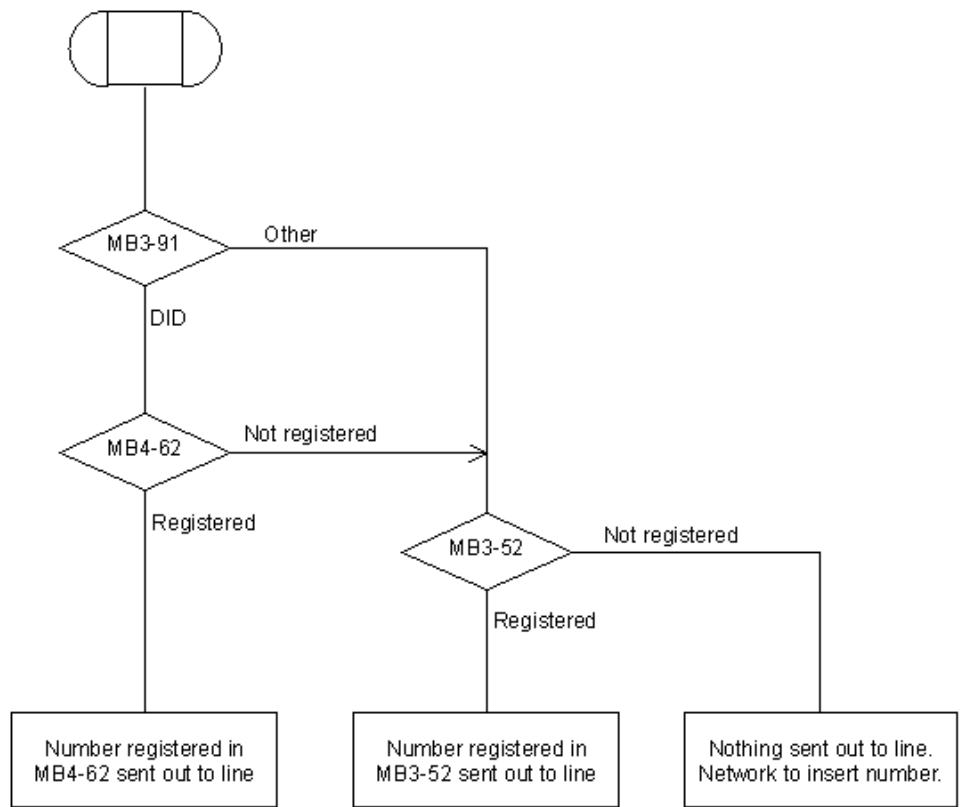

Figure A7-1: Flow Chart

THIS PAGE INTENTIONALLY LEFT BLANK

Call Forward - All Calls

C-8

FEATURE DESCRIPTION

The Call Forward - All Calls feature forwards all calls directed to one station, to another station, Voice Mail system, or to the Attendant. This permits more efficient call processing by allowing a station to be left unattended and have calls answered at another location. Call Forward - All Calls can be set or cancelled at the destination station. Attendant Positions can be used to cancel Call Forward - All Calls system-wide.

SYSTEM AVAILABILITY

Terminal Type





All stations.

Required Components





None.

OPERATING PROCEDURES





To set Call Forward - All Calls from a forwarding station:

1. Press the Call Forward All ON/OFF key.
2. Dial the station number or press .
- OR -
3. Press .
4. Dial  .
5. Dial the forward destination.
6. Press .

To set Call Forward - All Calls from Single Line Telephone or Multiline Terminal:

1. Lift the handset or press .
2. Dial Access Code   (set as default).
3. Dial the station number or hunt group master number where incoming calls are to be forwarded.
4. Receive the confirmation tone, and restore handset or press .

To set Call Forward - All Calls from Single Line Telephone or Multiline Terminal:

1. Lift the handset or press .
2. Dial Access Code   (set as default).
3. Dial the station number or hunt group master number where incoming calls are to be forwarded.
4. Receive the confirmation tone, and restore handset or press .





To verify (Multiline Terminals only):

1. A winking  LED indicates the station is in Call Forward - All Calls mode.
- OR -
2. The Feature Access or single On/Off key LED (if equipped) steadily lights if this setting is assigned on the key.





To cancel (Multiline Terminal only):

1. Press Call Forward - All Calls On/Off key.
2. Press .





To cancel (Single Line Telephone or Multiline Terminal):

1. Lift the handset or press .
2. Dial Access Code   (set as default).
3. Receive confirmation tone, and restore the handset or press .

To set from a destination station (Attendant Positions only):

1. Lift the handset or press .
2. Dial Access Code   (set as default).
3. Dial the station number to be forwarded.
4. Receive confirmation tone, and restore the handset or press .

To cancel from a destination station (Attendant Positions only):



1. Lift the handset or press .
2. Dial Access Code   (set as default).
3. Dial the station number where forwarding is to be cancelled.
4. Receive the confirmation tone, and restore the handset or press .

To cancel Call Forward - All Calls, Busy/No Answer, and Do Not Disturb system-wide (Attendant Positions only):



1. Press .
2. Dial Access Code  .
3. Press .

SERVICE CONDITIONS

Data Assignment

-  The ability to set Call Forward - All Calls/DND is based on Class of Service assignment.
-  Call Forward - All Calls can be set or cancelled by the forwarding station user or the destination station user if allowed by Class of Service.
-  Call Forward - All Calls set/cancel from destination or system-wide cancel can be performed at the Attendant Position if allowed by Class of Service.

Restrictions

-  At default, system-wide cancel of Call Forward - All Calls from Attendant Positions is not allowed.
-  Ring Transfer, Camp-On, and Tone Override cannot be set to a station that has Call Forward - All Calls set.
-  DND and Call Forward - All Calls cannot be set at the same time at a station.







General

- ⓘ If a station with Call Forward assigned receives a second call, and Call Forward is set to a busy station, the second incoming call does not follow the forwarding assignment unless the forwarding station becomes idle.
- ⓘ The Call Forward - All Calls set and cancel Access Codes can be programmed on separate Feature Access or One-Touch keys. A line key defined in system programming as Call Forward - All Calls set lights when Call Forward - All Calls is set. The Feature key LED flashes when Call Forward - All Calls is set.
- ⓘ All internal and transferred calls to the station follow the Call Forward - All Calls setting.
- ⓘ Tie/DID and DIT/ANA line calls follow Call Forward - All Calls setting.
- ⓘ A station can be the destination of any number of Call Forward - All Calls settings.
- ⓘ When the station user sets this feature, the associated red LED winks on any DSS/BLF key assigned for that station.
- ⓘ The destination station is the only station that can call a station with Call Forward - All Calls set.
- ⓘ Call Forward - All Calls has higher priority than Call Forward Busy, Call Forward - No Answer, or Call Forward - Busy/No Answer.
- ⓘ Secondary Incoming Extensions cannot be set for Call Forward - All Calls.
- ⓘ When Call Forward - All Calls is set, no indication is displayed in the LCD (if equipped) of the Multiline Terminal where Call Forward - All Calls was set.
- ⓘ Call Forward Split feature allows internal calls and external calls to be forwarded to different destinations.

RELATED FEATURES LIST

Feature Number	Feature Name
C-9	Call Forward - Busy/No Answer
C-11	Call Forward - Off-Premise
C-12	Call Forward - Split

GUIDE TO FEATURE PROGRAMMING

Order and Shortcut	System Data Name	Memory Block	Function	1-8-07 Attendant Page-Line Key	1-8-08 Station Page-Line Key
 +BA	Access Code (1-, 2- or 3-Digit) Assignment	1-1-46/47/48	030, 032, 033, 034, 142, 143		
 +BTS	* Class of Service (Attendant) Feature Selection 1	1-8-07		2-2, 2-3	
 +BTS	* Class of Service (Station) Feature Selection 2	1-8-08			1-1, 5-4
 +BTT	Station to Class of Service Feature Assignment	4-17			
 +BN	Line Key Selection	2-05			
 +BN	Line Key Selection for Tenant Mode	2-06			
 +BTM	Line Key Selection for Telephone Mode	4-12			

* When the system is at default this Memory Block **must** be programmed for the feature to be used.

THIS PAGE INTENTIONALLY LEFT BLANK

Call Forward - Busy/No Answer

C-9

FEATURE DESCRIPTION

The Call Forward - Busy/No Answer feature is used to forward calls directed to one station, to another station, Voice Mail system, or to the Attendant Position for Busy or Ring No Answer. This permits more efficient call processing by allowing calls to be routed to another station or to the Attendant Position.

SYSTEM AVAILABILITY

Terminal Type

All terminals.

Required Components

None.

OPERATING PROCEDURES

To set Call Forward - Busy/No Answer from a forwarding station:

1. Press Call Forward - Busy/No Answer ON/OFF key.
2. Dial the station number or press .

To cancel Call Forward - Busy/No Answer:

1. Press Call Forward - Busy/No Answer On/Off key.
2. Receive confirmation tone, and restore handset or press .

To cancel Call Forward - All Calls, Busy/No Answer, and Do Not Disturb system-wide from the Attendant Position only:

1. Press .
2. Dial Access Code  .
3. Press .

SERVICE CONDITIONS

Data Assignment

- ④ At default, the system-wide cancel of Call Forward - All Calls, Busy/No Answer, and Do Not Disturb from an Attendant Position is not allowed.
- ④ The ability to set and cancel Call Forward - Busy/No Answer is based on Class of Service assignment.
- ④ Access Codes can be assigned in System Programming to set and cancel Call Forward - Busy only and Call Forward - No Answer only. At default, no Access Codes are assigned.
- ④ Call Forward - Busy and Call Forward - No Answer can be set independently of each other to two separate stations. Separate Access Codes are required.
- ④ The time allowed for Call Forward - Busy/No Answer is programmable in System Programming (default: 10 seconds).







General

- ④ If a station with Call Forward assigned receives a second call, and Call Forward is set to a busy station, the second incoming call does not follow the forwarding assignment unless the forwarding station goes idle.
- ④ All internal and transferred calls to the station follow the Call Forward - Busy/No Answer setting.
- ④ Tie/DID and DIT/ANA line calls follow the Call Forward - Busy/No Answer settings.
- ④ Only one Call Forward - Busy/No Answer forwarding destination can be set from one station at a time.
- ④ A station can be the destination of any number of Call Forward - Busy/No Answer settings.
- ④ Call Forward-Busy/No Answer forwards to another station only once (cannot chain call).
- ④ Secondary Incoming Extensions cannot be set for Call Forward - Busy/No Answer.
- ④ Call Forward - All Calls has higher priority than Call Forward - Busy, Call Forward - No Answer, or Call Forward - Busy/No Answer.
- ④ If Call Forward - Busy/No Answer is set, camped-on calls and DIT/ANA calls forward after the No Answer Timer expires.
- ④ Call Alert Notification has a significant affect on Call-Forward Busy/No Answer.
- ④ Call Forward Split feature allows internal calls and external calls to be forwarded to different destinations.

RELATED FEATURES LIST

Feature Number	Feature Name
C-1	Call Alert Notification
C-7	Caller ID - Outgoing
C-8	Call Forward - All Calls
C-11	Call Forward - Off-Premise
C-12	Call Forward - Split

GUIDE TO FEATURE PROGRAMMING

Order and Shortcut	System Data Name	Memory Block	Function	1-8-07 Attendant Page-Line Key	1-8-08 Station Page-Line Key
 +BA	Access Code (1-, 2- or 3-Digit) Assignment	1-1-46/47/48	020~025, 140, 141		
 +BM	Call Forward - No Answer Time Selection	1-2-02			
 +BTS	* Class of Service (Attendant) Feature Selection 1	1-8-07		2-2, 2-3	
 +BTT	Station to Class of Service Feature Assignment	4-17			
 +BTS	* Class of Service (Station) Feature Selection 2	1-8-08			2-5, 5-4
 +BTM	Line Key Selection for Telephone Mode	4-12			
 +BTT	CO/PBX Busy Forward Station Assignment	4-13			

* When the system is at default this Memory Block **must** be programmed for the feature to be used.

THIS PAGE INTENTIONALLY LEFT BLANK

Call Forward - Display

C-10

FEATURE DESCRIPTION

When a call is forwarded from one Multiline Terminal to another, the forwarding indication and forward station number are shown on the Multiline Terminal display.

SYSTEM AVAILABILITY

Terminal Type

All Display Multiline Terminals.

Required Components

Multiline Terminals with display. Refer to C-7 Call Forward – All Call and C-8 Call Forward – Busy/No Answer features.

OPERATING PROCEDURES

Not applicable.

SERVICE CONDITIONS

General

- ④ DIT, ANA, DID, Tie, Automated Attendant transfer, and SCD calls can support Call Forward - Display.
- ④ This feature only supports forwarded calls to a primary station number. When the destination is a CAR key, the forwarding display information is not shown.
- ④ Internal calls do not show forwarding display.

THIS PAGE INTENTIONALLY LEFT BLANK

Call Forward - Off-Premise

C-11

FEATURE DESCRIPTION

The Call Forward - Off-Premise allows a station to forward an internal or outside call to an off-premise destination, using various trunk types in the Xen IPK System.

SYSTEM AVAILABILITY

Terminal Type

All terminals.

Required Components

None.

OPERATING PROCEDURES

To set Call Forward - All Calls from a forwarding station (Multiline Terminal only):

1. Press **Feature** in the idle mode.
2. Dial Access Code **6** **0** (fixed Access Code).
3. Dial the Trunk Access Code and telephone number where incoming calls are to be forwarded.
4. Press **Feature**.

- OR -

Press the Call Forward - All Calls ON/OFF key.

5. Dial the Trunk Access Code and telephone number.
6. Press **Speaker**.

To set Call Forward - All Calls from a Single Line Telephone or a Multiline Terminal:

1. Lift the handset or press **Speaker**.
2. Dial Access Code **4** **7** (set as default).
3. Dial the Trunk Access Code and telephone number where incoming calls are to be forwarded.
4. Restore the handset or press **Speaker**.

To verify Call Forward - All Calls (Multiline Terminals only):

A winking  LED indicates the station is in Forward - All Calls mode.





- OR -

The Feature Access or One-Touch key LED (if equipped) steadily lights if this setting is assigned on the key.

To cancel Call Forward - All Calls (Multiline Terminal only):

Press Call Forward - All Calls On/Off key.





To cancel Call Forward - All Calls from a Single Line Telephone or a Multiline Terminal:

1. Lift the handset or press .
2. Dial Access Code   (set as default).
3. Receive confirmation tone, and restore the handset or press .

To cancel Forward - All Calls, Busy/No Answer, and Do Not Disturb system-wide (Attendant Positions only):

1. Press .
2. Dial Access Code   (fixed Access Code).
3. Press .







To set Call Forward - Busy/No Answer from forwarding station:

1. Lift the handset or press .
 2. Dial the Call Forward - Busy/No Answer Access Code   (set as default).
 3. Dial the Trunk Access Code and telephone number where incoming calls are to be forwarded.
 4. Go on-hook or press .
- OR -**
1. Press the Call Forward Busy/No Answer ON/OFF key.
 2. Dial the Trunk Access Code and telephone number.
 3. Press .







To cancel Call Forward - Busy/No Answer:

1. Press Call Forward - Busy/No Answer On/Off key.
2. Receive confirmation tone, and restore handset or press .

To set Call Forward - Off-Premise for Call Arrival (CAR) Key:



1. Lift the handset or press .
2. Dial Access Code
 -   = Busy/No Answer
 -   = All Calls
3. Enter CAR extension number.
4. Enter Trunk Access Code (e.g. 0).
5. Enter the external number required.
6. Restore the handset or press .

To Cancel Call Forward - Off-Premise for Call Arrival (CAR) Key:

1. Lift the handset or press .
2. Dial Access Code
 -   = Busy/No Answer
 -   = All Calls
3. Enter CAR extension number.
4. Restore the handset or press .

SERVICE CONDITIONS

Data Assignment

-  The ability to set Call Forward - Off-Premise is based on Station Class of Service.
-  When Call Forward - All Calls is set and an outgoing outside line is not available, the Automated Attendant call is not forwarded and a busy tone is sent to the calling party or the Automated Attendant switches to normal Day or Night ringing.

Restrictions

- ④ A maximum of 24 digits, including pauses can be stored as the destination outside number. (The Trunk Access Code is not counted as part of the 24-digit number.)
- ④ When Call Forward - Busy/No Answer is set, the caller hears ringback tone until a trunk becomes available. If an outside line is not available, DIT/ANA calls are not forwarded, these calls remain at the station setting the Call Forward - Off-Premise until a line becomes available.
- ④ Even when Call Forward - Off-Premise is set, Recall, Trunk Queuing, and Automatic Callback calls directed to the extension line **are not** forwarded.
- ④ The Call Forward destination number cannot be routed by Least Cost Routing or by Automatic Carrier Routing.

General











- ④ Features like Code restriction, or forced account codes that are enabled for the Call forward - Off-Premise extension apply to any call that follows Call forward - Off-Premise.
- ④ The Feature key LED flashes red when Call Forward - Off-Premise (All Calls) is set from a Multiline Terminal.
- ④ The ACD/UCD overflow destination station can be set to Call Forward - Off-Premise.
- ④ The Access Codes for Call Forward set and cancel can be programmed on Feature Access keys or One-Touch keys. If the key is pressed during the conversation with an internal or outside party, the call is placed on hold and the Access code is dialed.
- ④ If a Call Forward On/Off key (All or Busy/No Answer) is programmed on the line key via System Programming, set/cancel toggles. The Trunk Access Code and destination outside number need to be dialed after pressing this key when setting Call Forward-Off-Premise.
- ④ Incoming calls from a voice mail system follows the Call Forward - Off-Premise setting.
- ④ A Call Arrival key (CAR) number can be set for Call Forward - Off-Premise.
- ④ The Speed Dial number cannot be set as the destination forward number.
- ④ If the system is installed in the Key Function (KF) mode, a Specified Line Seizure Access Code must be used when setting Call Forward - Off-Premise.
 - The following incoming calls can be forwarded:
 - CO/PBX Transferred Call
 - Ordinary Incoming Internal Call
 - Direct Inward Termination (DIT)
 - Assigned Night Answer (ANA)

- Direct Inward Dialling (DID)
 - Tie Line
 - Automated Attendant (AA)
- ④ If the outside party, where the call is forwarded, is busy or does not answer, the call is terminated when the calling party hangs up.
 - ④ If the station is set for Call Forward - All calls and an outgoing outside line is not available, the DID/Tie internal call is not forwarded. The calling party hears a busy tone.
 - ④ When an ISDN/Tie/DID call is forwarded from an outside line to another outside line, pad control is applied according to the System Data assigned on Memory Block 3-31 (Trunk External Transmit Pad Selection) and Memory Block 3-32 (Trunk External Receive Pad Selection).
 - ④ After a call has been forwarded to an outside line, the call is disconnected when the Tandem Transfer Automatic Disconnect Timer has expired.
 - ④ An alert tone is provided to both the calling party and to the destination outside party one minute before the Tandem Transfer Automatic Disconnect Time runs out.
 - ④ An outgoing call is charged to the internal calling party even if the destination outside party does not answer or is busy when printed via Station Message Detail Recording (SMDR).
 - ④ The destination number is output through SMDR as the call record for the station setting Call Forward - Off-Premise. When incoming outside calls are received, 999 is printed on the report. When incoming internal calls are received, the station number of the calling party is printed on the report.
 - ④ Call Forward Split feature allows internal calls and external call be forwarded differently.

RELATED FEATURES LIST

Feature Number	Feature Name
A-25	Automatic Redial
C-7	Caller ID - Outgoing
C-8	Call Forward - All Calls
C-9	Call Forward - Busy/No Answer
C-19	Code Restriction
C-12	Call Forward - Split
S-1	Save and Repeat

GUIDE TO FEATURE PROGRAMMING

Order and Shortcut	System Data Name	Memory Block	Function	1-8-07 Attendant Page-Line Key	1-8-08 Station Page-Line Key
 +BA	Access Code (1-, 2- or 3-Digit) Assignment	1-1-46/47/48	020~ 025 033, 034, 140~143		
 +BTS	* Class of Service (Attendant) Feature Selection 1	1-8-07		2-2, 2-3	
 +BTS	* Class of Service (Station) Feature Selection 2	1-8-08			5-4
 +BTT	Station to Class of Service Feature Assignment	4-17			
 +BCT	Trunk-to-Trunk Transfer Yes/No Selection	3-04			
 +BCT	Polarity Reversal Selection	3-90			
 +BTM	Line Key Selection for Telephone Mode	4-12			
 +BN	Line Key Selection	2-05			
 +BN	Line Key Selection for Tenant Mode	2-06			
 +AT	Tandem Transfer Automatic Disconnect Time Selection	1-4-00			

* When the system is at default this Memory Block **must** be programmed for the feature to be used.

Call Forward - Split

C-12

FEATURE DESCRIPTION

The Call Forward - Split feature allows a station to forward internal or external calls to different locations, such as Voice Mail, Off Site, Attendant position or another station. Split forwarding is allowed for All Call, Busy, or Ring/No Answer to provide more efficient call processing.





SYSTEM AVAILABILITY

Terminal Type
All Stations.





Required Components
None.

OPERATING PROCEDURES





To set Call Forward - Busy/No Answer Split:

1. Lift handset or press .
2. Dial the Call Forward - Busy/No Answer Split Set Access Code _____ (default not assigned).
3. Dial  for internal or  for External.
4. Dial the destination number.
5. Press .





To cancel Call Forward - Busy/No Answer Split:

1. Lift handset or press .
2. Dial the Call Forward - Busy/No Answer Split Set Access Code _____ (default not assigned).
3. Dial  for internal or  for External.
4. Press .





To set Call Forward - All Split:

1. Lift handset or press .
2. Dial the Call Forward - All Split Set Access Code _____ (default not assigned).
3. Dial  for internal or  for External.
4. Dial the Trunk Access Code and the telephone number for the destination number.
5. Press .





To cancel Call Forward - All Split:

1. Lift handset or press .
2. Dial the Call Forward - All Split Set Access Code _____ (default not assigned).
3. Dial  for internal or  for External.
4. Press .

To set Call Forward - All or Busy/No Answer Split from destination CAR key:







1. Lift handset or press .
2. Dial the Set Access Code for All or Busy/No Answer Split from destination _____ (default not assigned).
3. Dial  for internal or  for External.
4. Dial CAR key or Station Number to be forwarded.
5. Dial the Trunk Access Code and the telephone number for the destination number.
6. Go on-hook or press .

To cancel Call Forward - All or Busy/No Answer Split from destination CAR key:



1. Lift handset or press .
2. Dial the Cancel Access Code for All or Busy/No Answer Split from destination _____ (default not assigned).
3. Dial  for internal or  for External.
4. Dial CAR key or Station Number to be forwarded.
5. Go on-hook or press .

SERVICE CONDITIONS

General

-  Even when logging on as an ACD agent, an individual call not through the Pilot Number is Call Forwarded.
 -  When a call is transferred to an extension with Call Forward ñ Split set, the Split feature follows the Internal destination when the Transfer, Hold, or Conf key is pressed.
 -  Call Forward — Split supports the following:
 - Call Forward — All Call
 - Call Forward — Busy
 - Call Forward — No Answer
 - Call Forward — Busy/No Answer
 - Call Forward — Busy/No Answer for CAR
- Note:** Call Forward – Off-Premise can be set for all of the above.
-  When setting Call Forward, both Internal and External calls have the same forwarding destination when any other forwarding is used.
 -  The Call Forward On/Off toggle key LED is on when both Internal and External calls have the same forwarding destination.
 -  When a station is logged in as an ACD agent and Call Forward-Busy/No Answer is set, any non-ACD call transferred or ringing to that station follows the Call Forward setting.







Restrictions

-  The Split feature is not supported for Call Forward – All Call by the FEATURE + 60 operation from destination.
-  The Split feature is not supported for Single On/Off toggle key operation.
-  Setting, cancelling or Call Forwarding is allowed only when logged out of ACD.

RELATED FEATURES

Feature Number	Feature Name
C-8	Call Forward - All Calls
C-9	Call Forward - Busy/No Answer
C-11	Call Forward - Off-Premise

GUIDE TO FEATURE PROGRAMMING

Order and Shortcut	System Data Name	Memory Block	Function	1-8-07 Attendant Page-Line Key	1-8-08 Station Page-Line Key
 +BA	* Access Code (1-, 2- or 3-Digit) Assignment	1-1-46/47/48	154~159		
 +BTS	* Class of Service (Attendant) Feature Selection 1	1-8-07		2-2, 2-3	
 +BTS	* Class of Service (Station) Feature Selection 2	1-8-08			1-1, 2-5, 5-4
 +BTT	Station to Class of Service Feature Assignment	4-17			
 +BTM	Call Forward-Busy Immediately/Delay Selection	4-42			
 +BM	Call Forward- No Answer Time Selection	1-2-22			
 +BCT	Truck-to-Trunk Transfer Yes/No Selection	3-04			

* When the system is at default this Memory Block **must** be programmed for the feature to be used.

Call Park - System

C-13

FEATURE DESCRIPTION

The Call Park - System feature allows the user to place a call into one of 10 common Call Park - System locations. This can be done from any station in the system. This feature allows the call to be removed from the station and frees that station to answer other calls. The call can be retrieved from System Call Park at any station in the system.

SYSTEM AVAILABILITY

Terminal Type

All terminals.

Required Components

None.

OPERATING PROCEDURES

To set from a Multiline Terminal:

1. With a call in progress, press **Transfer**, and receive internal dial tone (the party is placed on Hold).
2. Dial the Call Park Set Access Code **4** ***** (set as default).
3. Dial the Call Park location number (**0** ~ **9**), and receive confirmation tone; the call is parked.
4. Restore the handset.

To set from a Single Line Telephone:

1. With a call in progress, press the hookswitch, and receive internal dial tone (the party is placed on Exclusive Hold).
2. Dial the Call Park Set Access Code **4** ***** (set as default).
3. Dial the Call Park location number (**0** ~ **9**), and receive confirmation tone; the call is parked.
4. Restore the handset.

To retrieve a parked call from either a Multiline Terminal or a Single Line Telephone:

1. Go off-hook, and receive internal dial tone.
2. Dial the Call Park Retrieve Access Code $\textcircled{4}$ $\textcircled{\#}$ (set as default).
3. Dial the Call Park location number ($\textcircled{0}$ ~ $\textcircled{9}$) of the call to be retrieved.
4. Talk with party.



**SERVICE
CONDITIONS****Data Assignment**

- \textcircled{f} A recall timer for a parked call can be programmed in System Programming (default: 1 minute).

General

- \textcircled{f} Any call left in Call Park for more than the programmed time recalls to the station where the call was originally parked. The Call Park location becomes idle after the recall, and the trunk line key switches to Non-Exclusive Hold.
- \textcircled{f} When attempting to set Call Park to a busy Call Park location, and a busy tone is heard, Step Call can be used to access an idle location to park the call.
- \textcircled{f} If a station other than the station originally used to park the call retrieves the call, the SMDR records a transfer to the station where the call is retrieved.
- \textcircled{f} When a Call Park is in recall mode, the call cannot be picked up using the Call Park retrieval Access Code.
- \textcircled{f} Call Park is set and retrieved from internal dial tone.
- \textcircled{f} Outside calls and internal calls can be parked from any station.
- \textcircled{f} Conference calls cannot be parked.
- \textcircled{f} When attempting to set Call Park while all Call Park locations are busy, a busy tone is heard and ALL PARK BUSY is displayed on Multiline Terminals with LCDs.

GUIDE TO FEATURE PROGRAMMING

Order and Shortcut	System Data Name	Memory Block	Function	1-8-07 Attendant Page-Line Key	1-8-08 Station Page-Line Key
 +BA	Access Code (1-, 2- or 3-Digit) Assignment	1-1-46/47/48	047, 048		
 +BM	System Call Park Recall Time Selection	1-2-23			

THIS PAGE INTENTIONALLY LEFT BLANK

Call Pickup Direct

C-14

FEATURE DESCRIPTION

This feature allows station users to answer any calls directed at another station from their station. This permits efficient handling of calls that are directed to unattended stations.

SYSTEM AVAILABILITY

Terminal Type



All terminals.

Required Components

None.

OPERATING PROCEDURES

To receive an incoming call:

1. Unattended station A receives a call.
2. Press  or lift the handset at station B.
3. Dial Access Code   (set as default).
4. Dial the number for station A and begin talking.

SERVICE CONDITIONS

General

-  The Call Pickup Direct feature answers the following calls:
 - Intercom Ringing
 - Intercom Voice
 - CO/PBX Incoming
 - DIT/ANA
 - VRS/Automated Attendant Transfer
 - DID/Tie Incoming
 - ACD/UCD Incoming
 - Camp-On Recall
 - Hold Recall
 - Off-Hook Ringing
 - Transfer Recall
 - Call Forward
 - Delayed Ringing
 - CO Ring Forward
 - Ring Transfer
 - Step Call
 - Call Park Recall

- ④ The Call Pickup Direct Feature cannot be used to answer the following calls:
 - CAR extension number
 - Call Alert
 - A station that is in DND mode
 - Calls to Private Lines if no Private Line is assigned at the station doing the call pickup
 - Trunk Queuing Recall
 - Automatic Callback Ringing

- ④ If different calls are received at a station, the following Call Pickup priorities are used by the system:
 1. Internal Calls
 2. DIT/ANA Calls
 - › DID Calls
 - › E&M Calls
 3. VRS/Automated Attendant Transfer Calls
 4. Ring Transfer Calls
 5. CO/PBX Calls
 6. Calls on SIE/CAR keys
 7. Recalls (DIT/ANA, DID, E&M calls are the same priority)

- ④ If more than one of the same type of calls are received at a station, the following Call Pickup priorities are used by the system:
 - Ordinary Incoming CO/PBX Calls
After the first call is picked up, the lowest numbered CO/PBX Trunks are picked up (*i.e.*, if a call is received on Trunks 01 and 02, then Trunk 01 is picked up first).
 - Calls on SIE/CAR keys
First In/First Out
 - DIT, DID, VRS/Automated Attendant Transfer Calls
First In/First Out
 - Ring Transferred CO/PBX Calls
After the first call is picked up, the lowest numbered CO/PBX Trunks are picked up (*i.e.*, if a call is received on Trunks 01 and 02, then Trunk 01 is picked up first).
 - Recalls
After the first internal call is picked up, the lowest numbered CO/PBX Trunks are picked up (*i.e.*, if a call is received on Trunks 01 and 02, then Trunk 01 is picked up first).

- ④ CAR/SIE incoming calls are answered by dialling the station number where the CAR/SIE call is ringing.

- ④ The Call Pickup Direct Access Code can be programmed on a Feature Access key or One-Touch key.

- ④ Station Message Detail Recording prints the Call Pickup originating station number.
- ④ Call Pickup Direct is allowed between different tenants.
- ④ A station that does not have the CO/PBX line key or an available CAP key cannot pick up the ringing outside line from the ringing station.

GUIDE TO FEATURE PROGRAMMING

Order and Shortcut	System Data Name	Memory Block	Function	1-8-07 Attendant Page-Line Key	1-8-08 Station Page-Line Key
 +BA	Access Code (1-, 2-, or 3-Digit) Assignment	1-1-46/47/48	042		

THIS PAGE INTENTIONALLY LEFT BLANK

Call Pickup Group

C-15

FEATURE DESCRIPTION

Any station user can answer a call intended for another station user either in their programmed Call Pickup group (Tenant Assignment) or another Tenant Group, depending on the Call Pickup Access Code used. Incoming ringing outside calls to a station can be answered by any station in the same Call Pickup group or by stations in other Tenant groups. The system can be subdivided into 48 separate Tenant groups, each with its own outside line assignments.

SYSTEM AVAILABILITY

Terminal Type







All terminals.

Required Components

None.

OPERATING PROCEDURES

To use this feature from a station:

1. Station A is receiving a call.
2. Press  or lift the handset at station B.
3. Dial the Call Pickup Access Code.
Default Access Codes are:
 -   Intra-Tenant Ringing Call Pickup
 -   Night Call Pickup
 -   For CO/PBX lines in same tenant
4. Use the handset to talk to the party calling station A.

SERVICE CONDITIONS

Data Assignment

- ④ Other types of Call Pickups that can be assigned but do not have an Access Code at default are:
 - Call Pickup (PBX only) in same tenant.
 - Call Pickup (CO only) in same tenant.
 - Call Pickup (CO/PBX) by tenant (1-digit).
 - Call Pickup (CO/PBX) by tenant (2-digit).
 - Call Pickup (CO/PBX) for other tenants.
 - Internal (CO/PBX) Transfers, Tie/DID, Call Pickup in same tenant.
 - Call Pickup (Tie) outside call ringing to Internal Zone Paging Group.
 - For main software release 2 and above, Call Pickup Extension Group.



Restrictions

- ④ Voice announced internal calls cannot be picked up in the same Tenant Group.

General

- ④ Call Pickup Groups are created by assigning Tenant Groups. A maximum of 48 Call Pickup Groups can be assigned.
- ④ All Calls Pickup Access Codes are valid for both Day Mode and Night Mode except the Night Call Pickup Access Code. The Night Call Pickup Access Code is valid when a tenant is in Night Mode and assigned the Night Chime feature in System Programming.
- ④ An incoming Tie/DID call is first treated as an internal call. After timeout (default: No Timeout), the incoming call is treated as an incoming CO/PBX outside call.
- ④ If incoming calls terminate on two or more stations simultaneously, the internal call with the lowest station number is answered first.
- ④ To Call Pickup a Secondary Incoming Extension, a user must dial the applicable Access Code to pick up the original call.
- ④ Call Pickup Extension Groups are created by assigning groups with Extension Numbers. A maximum of 10 groups of 30 extensions can be created.

GUIDE TO FEATURE PROGRAMMING

Order and Shortcut	System Data Name	Memory Block	Function	1-8-07 Attendant Page-Line Key	1-8-08 Station Page-Line Key
 +BA	Access Code (1-, 2-, or 3-Digit) Assignment	1-1-46/47/48	052, 053, 057, 060, 061, 066~069		
 +BN	Trunk to Tenant Assignment	2-01			
 +BTT	Telephone to Tenant Assignment	4-09			

THIS PAGE INTENTIONALLY LEFT BLANK

FEATURE DESCRIPTION

Centralised Voice Mail allows two or more systems that are connected by Tie Lines to share one Voice Mail (VM) system. This feature allows VM Box access from Intercom (ICM)/CO/Automated Attendant, VM message LED indication, or Call Forward – Off-Premise to a VM port. The Xen IPK system communicates Message Waiting (MW) LED, Mailbox and other information using DTMF signalling between two Xen IPK systems.

SYSTEM AVAILABILITY

Terminal Type
All Terminals.

Required Components

VMS(2/ 4/8)-U() or FMS(2/ 4)-U() ETU
TLI(2)-U ETU or IPT(4/8)-U() ETU

OPERATING PROCEDURES

Refer to Digital Voice Mail, on Page 247 and Voice Mail Integration (Analogue), on Page 607.

SERVICE CONDITIONS

General

- ④ The Voice Mail system controls the Voice Mail Message Indication for systems without Voice Mail using Analogue or Digital Tie Lines.
- ④ Centralised Voice Mail does not require upgrade of the Digital Voice Mail System.
- ④ When using multiple systems in a network, Internal/External Pad Selection may need adjustment to compensate for volume loss.
- ④ Using Multiple Call forwarding to transfer calls between systems is not recommended.
- ④ Use Memory Block 1-2-04 (Call Arrival Key Block Assignment) to assign the CAR key that is used to deliver message-waiting notification to the systems in the Closed Numbering Network. This is common to all systems that have Centralised Voice Mail.
- ④ Use Memory Block 1-8-47 (Call Arrival Key Voice Mail Message Notification Assignment) to assign the CAR Key used to send Voice Mail Message Notification to other systems in the Closed Numbering Network.

Restrictions

- ④ Each system must have a Voice Mail Quick Transfer Master Hunt number assigned, but Voice Mail Call Back Indication is not supported in the system without Voice Mail.
- ④ The Closed Numbering Network is required to support Centralised Voice Mail. Refer to U-3 in this Manual for details.
- ④ All systems in the Closed Numbering Network using the same Voice Mail must assign the same Access codes for Memory Block 1-1-46~48, Functions 502 and 503, to set or cancel message indication.
- ④ Systems without Voice Mail can access DIT/ANA trunks to the Automated Attendant of the Centralised Voice Mail using a CAR key that has Call Forward – Off-Premise to the Voice Mail pilot.
- ④ Softkey indication is not supported in remote systems. Refer to & Features Supported by Digital Voice Mail: for a detailed list of supported features.
- ④ Analogue voice cannot be used to support Centralised Voice Mail.
- ④ Features Supported by Digital Voice Mail:









Feature Name	Main	Remote
Alphabetic Directory	Yes	Yes
Alternate Greeting	Yes	Yes
Automated Attendant	Yes	Yes
Archived Message	Yes	Yes
Audiotext	Yes	Yes
Audiotext Message	Yes	Yes
Auto Dial	Yes	Yes
Automatic Directory	Yes	Yes
Await Answer	Yes	Yes
Broadcast Distribution	Yes	Yes
Call Forward to Personal Greeting	Yes	Yes
Call Screening	Yes	Yes
Directory Assistance	Yes	Yes
Directory Group	Yes	Yes
Directory Menu	Yes	Yes
Dispatch Distribution	Yes	Yes



Feature Name	Main	Remote
Greetings	Yes	Yes
Group	Yes	Yes
Held Message	Yes	Yes
Interview Box	Yes	Yes
Introduction	Yes	Yes
Live Record	Yes	No
Live Monitoring	Yes	No
Message Box Integration	Yes	Yes
Message Delivery	Yes	No
Message Group	Yes	Yes
Message Notification	Yes	Yes
Message Waiting Lamps	Yes	Yes
Names	Yes	Yes
Night Mode	Yes	Yes
Numeric Directory Assistance	Yes	Yes
Open Group	Yes	Yes
One-Key Dialling	Yes	Yes
One-Way Message	Yes	Yes
Opening Greeting	Yes	Yes
Option Set	Yes	No
Outside Callers	Yes	Yes
Owner	Yes	Yes
Personal ID	Yes	Yes
Personal Secretary	Yes	Yes
Private Group	Yes	Yes
Prompt	Yes	Yes
Public Message	Yes	Yes
Quick Transfer to Voice Mail	Yes	No
Recorded Name	Yes	Yes
Release	Yes	Yes
Screening Options	Yes	Yes
Softkey Support	Yes	No







Feature Name	Main	Remote
Spelled Name	Yes	Yes
Subscriber	Yes	Yes
System Manager	Yes	Yes
Two-Way Message	Yes	Yes
Transaction Box	Yes	Yes
Voice Detect	Yes	Yes
Voice Field	Yes	Yes
Voice Name	Yes	Yes
Voice Response	Yes	Yes
Wait for Ringback	Yes	Yes

Note : Automated Attendant can be supported on the Remote System only when a DIT call to a CAR key is assigned Call Forward – Off Premise to Voice Mail in the main system.

GUIDE TO FEATURE PROGRAMMING

Order and Shortcut	System Data Name	Memory Block	Function	1-8-07 Attendant Page-Line Key	1-8-08 Station Page-Line Key
 +BS	Card Interface Slot Assignment	7-1			
 +BS	Telephone Type Assignment	7-2			
 +BK	* Call Arrival Key Block Assignment	1-2-04			
 +BTI	Voice Mail/SLT Selection	4-35			
 +BS	* Station Number Assignment	4-10			
 +AV	* Call Arrival Key Voice Mail Message Notification Assignment	1-8-47			
 +BTT	* Intercom Master Hunt Number Selection	4-14			
 +BTT	* Intercom Master Hunt Number Forward Assignment	4-15			
 +BTT	Station Name Assignment	4-18			

Order and Shortcut	System Data Name	Memory Block	Function	1-8-07 Attendant Page-Line Key	1-8-08 Station Page-Line Key
 +BA	Intercom Feature Access Code Assignment	1-2-24	007		
 +BTS	Class of Service (Station) Feature Selection 2	1-8-08			3-5,5-4
 +AV	* Voice Mail Quick Transfer Master Hunt Number	1-8-26			
 +BA	* Access Code (1-, 2-, 3-Digit) Assignment	1-1-46~48	001, 401~416, 502, 503, 020~025, 030, 032, 033, 034, 140~145, 150~159		
 +BCS	* Networking Trunk Group/Route Advance Assignment	1-1-49			
 +BCS	* CO/PBX Outgoing Digit Add Assignment	1-1-50			
 +BCT	* Trunk Type Selection	3-91			
 +BCT	* Trunk-to-Trunk Group Assignment	3-03			
 +BCT	Trunk-to-Trunk Transfer Yes/No Selection	3-04			
 +BCT	Trunk (Installed, DP/DTMF) Selection	3-92			
 +BCT	* Trunk-to-Trunk Transfer Yes/No Selection	3-04			
 +ALN	Tie Line Networking Tandem Connection Assignment	5-01			
 +AV	Voice Mail DTMF Delay Time Selection	1-3-08			
 +AV	Voice Mail Disconnect Time Selection	1-3-09			
 +AV	Voice Mail DTMF Duration/Interdigit Time Selection	1-3-10			
 +BN	Trunk to Tenant Assignment	2-01			
 +BTT	Telephone to Tenant Assignment	4-09			
 +BN	Line Key Selection for Tenant Mode	2-06			
 +BTM	Line Key Selection for Telephone Mode	4-12			
 +BCT	DIT Assignment	3-42			

Order and Shortcut	System Data Name	Memory Block	Function	1-8-07 Attendant Page-Line Key	1-8-08 Station Page-Line Key
 +BCT	ANA Assignment	3-43			
 +BCT	DIT/ANA Delay Answer Time Selection	3-61			
 +BCT	DIT Tenant Assignment	3-62			
 +BCT	DIT Weekend Mode Selection	3-63			
 +BCT	DIT Night Mode Delay Answer Selection	3-64			
 +BTT	Call forward - Busy Immediately/Delay Selection	4-42			
 +BM	Call forward - No Answer Time Selection	1-2-22			

* When the system is at default this Memory Block **must** be programmed for the feature to be used.

Class of Service

C-17

FEATURE DESCRIPTION

The Class of Service assigns and controls access to features. Various Class of Service Combinations can be programmed. Stations are then assigned according to the features they can access.

SYSTEM AVAILABILITY

Terminal Type
All terminals.

Required Components
None.

OPERATING PROCEDURES

Not applicable.

SERVICE CONDITIONS

Data Assignment

- ④ Class of Service assignments have two types: Class of Service (Attendant) Feature Selection 1 allows assignment of Attendant related features. Class of Service (Station) Feature Selection 2 relates to station features.
- ④ Each Class of Service provides 16 different Classes.
- ④ Each station is assigned to one class for both Class of Service Assignments.
- ④ At default for Class of Service (Attendant) Feature Selection 1, Station Class 00 is set to allow all features (except Item Number 10) and Station Classes 01~15 are set to deny all features.
- ④ At default for Class of Service (Attendant) Feature Selection 1, Stations 100 and 101 are set for Class 00 and all others stations are designated Class 15.

General

- ④ The following Attendant features can be allowed or denied in each class for Class of Service assignment (Attendant) Feature Selection 1:

Features	Default Values (Station Ports 01 & 02)
Night Mode Switching (System-Wide)	Allow
Night Mode Switching (Tenant)	Allow
System Speed Dial Programming	Allow
Automatic Trunk-to-Trunk Transfer (Set/Reset) and Programming of Outgoing Numbers	Allow
Automated Attendant Mode/DISA Mode (Set/Reset)	Allow
Timed Alarm (Set/Reset) for Single Line Telephones (From Attendant)	Allow
Call Forward – All Call (Set/Reset) from Destination Station Call forward CAR extensions Call forward BNA	Allow
System-Wide Reset of Timed Alarm, Call Forward – All Call, Do Not Disturb, Customised Message, and Callback Request	Deny
Cancel Station Lockout and Default Password for Another station	Allow
DISA Password Cancel	Allow
DISA Password Confirmation	Allow
Automated Attendant Weekend Mode (Set/Reset) per Tenant	Allow
Forced Account Code Programming	Allow
Terminal Exchange Mode Set	Allow



The following features can be allowed/denied in each class level for Class of Service (Station) Feature Selection 2 assignment.

Features	Default Value (All Stations)
Set/Cancel Call Forward – All Call, Do Not Disturb (DND), Break Mode	Allow
Trunk Queuing	Allow
Automatic Callback	Allow
Barge-In Originate on a CO/PBX Line (Calling Party)	Deny
Barge-In Receive (Called Party)	Allow
Timed Alarm (Set/Cancel) From SLT	Allow
General Purpose Relay	Allow
Voice Override/Tone Override (Originate)	Allow
Absence Message	Allow
Callback Request Originate	Allow
Station Outgoing Lockout (Set/Cancel)	Allow
Call Forward – Busy/No Answer Set	Allow
VRS Voice Message Record/Verify/Erase	Allow
DISA Password Set	Allow
User Ringing Line Preference Set/Reset	Allow
Voice/Tone Override/Camp-On Receive	Allow
LCR Bypass (Trunk Groups 02~32)	Deny
Station Trunk-to-Trunk Transfer	Deny
Account Code Entry	Deny
Digit Restriction Time Selection	Allow
Call Alert Notification for DIT and DID	Allow
LCR Recall	Allow
DSS Key Transfer Operation	Deny
Caller ID Indication	Deny
Caller ID Number/Name Selection	Deny
Manual Live Record Activate (Memory Block 1-8-26 must be set)	Deny
Auto Live Record Activate (LK5 must be on, and Memory Block 1-8-26 must be set)	Deny
BGM Selection	Allow

Features	Default Value (All Stations)
Unsupervised Conference	Deny
Account Code Forced/Verified	Deny
Group Listening Selection	Deny
Station Relocation	Allow
Set Call Forward – Off-Premise (Related to page 1 LK1 and page 2 LK5)	Deny
Pre-set Dialling (Allow/Deny)	Deny
Live Monitoring	Deny
Caller ID Display Selection (When allow is set, Caller ID Name and Number is displayed on the top and centre rows of LCD at the same time.)	Deny
Malicious Call Trace (MCT)	Deny
ACR Normal Originate	Deny
Voicemail Message Indication	Deny
Account Code Forced/ Unverified	Deny
ISDN Supplementary Services	Deny

- ④ At default for Class of Service (Station) Feature Selection 2, Station Class 00 is set to Allow most features. Station Classes 01~15 are set to Deny all features.
- ④ At default for Class of Service (Station) Feature Selection 2, all stations are set for Class 00.

GUIDE TO FEATURE PROGRAMMING

Order and Shortcut	System Data Name	Memory Block	Function	1-8-07 Attendant Page-Line Key	1-8-08 Station Page-Line Key
 +BTS	Class of Service (Attendant) Feature Selection 1	1-8-07		All used Line Keys	
 +BTS	Class of Service (Station) Feature Selection 2	1-8-08			All used Line Keys
 +BTT	Station to Class of Service Feature Assignment	4-17			

THIS PAGE INTENTIONALLY LEFT BLANK

Clock/Calendar Display

C-18

FEATURE DESCRIPTION

The Clock/Calendar Display is available on Multiline Display Terminals. This feature displays the time and day of the week on the LCD. It is programmable from the first two station ports in the system.

SYSTEM AVAILABILITY

Terminal Type

All Multiline Terminals with LCD.

Required Components

None.

OPERATING PROCEDURES

To set the Clock/Calendar from a Multiline Terminal with an LCD connected to Port 01 or 02:

1. Press **Feature**.
2. Dial **9** (WXYZ).
3. Dial **#**.
4. Dial current time (e.g., **0** **3** **2** **9** (0 3 2 9)).
5. Press **Recall** to toggle AM/PM.
6. Press **Hold** to advance to the calendar.
7. Press **Recall** to select the day of the week.
8. Press **#** to move the cursor to the day of month setting.
9. Enter the day by using the dial pad.
10. Press **Recall** to select the month.
11. Press **#** to move the cursor to the year setting.
12. Enter the year by using the dial pad (only the last two digits are entered).
13. Press **Feature**.

Note: If only setting the time, press **Feature** after making the changes.

SERVICE CONDITIONS

Data Assignment

- The clock can be assigned to display 12 hours (12:00 to 11:59 AM, 12:00 to 11:59 PM) or 24 hours (00:00 to 23:59) system-wide via System Programming (default: 12-hour clock).



Restrictions

- The Clock/Calendar Display is programmed only from station ports 01 and 02.

General

- The Clock/Calendar Display feature is protected by the memory backup battery.

GUIDE TO FEATURE PROGRAMMING

Order and Shortcut	System Data Name	Memory Block	Function	1-8-07 Attendant Page-Line Key	1-8-08 Station Page-Line Key
 +BM	Time Display (12h/24h) Selection	1-8-04			
 +BM	Automatic Daylight Saving Time Selection	1-8-48			

* When the system is at default this Memory Block **must** be programmed for the feature to be used.

FEATURE DESCRIPTION

The Code Restriction feature is an advanced system of restricting outgoing calls based on the first eight digits dialed. Code Restriction denies outside calls based on number dialed over a trunk group, and accommodates equal access to Other Common Carriers (OCCs) as well as CO Feature Codes. This eliminates unauthorized calls and configures system calling functions to provide cost control.

SYSTEM AVAILABILITY

Terminal Type

All terminals.

Required Components

None.

OPERATING PROCEDURES

When a station user attempts an outside call and the station is code restricted, the following occurs:

1. The user goes off-hook, receives internal dial tone, and dials a Trunk Access Code or goes off-hook on an outside line.
2. The user receives an outside dial tone.
3. The user dials a restricted telephone number.
4. The user receives a reorder tone, and ERROR is displayed on the LCD (if equipped).

SERVICE CONDITIONS

Data Assignment

- ④ System Programming has 16 classes (class 00~15). Two of the 16 classes are fixed restrictions: class 00 allows all outside calls and class 15 restricts all outside calls (default: Allow all outside calls for all stations).
- ④ Each table can be assigned individually as an Allow or Deny Table in the Class Assignment.
- ④ Each station is assigned to a class for the Day Mode and Night Mode separately, per station, as required.
- ④ CO Feature Codes can be programmed in the system. Code Restriction applies after CO Feature Code is dialed.

- ④ When the system is installed behind a PBX or Centrex, the PBX/ Centrex Trunk Access Codes can be programmed in the system and this code is ignored in the restriction table.
- ④ The system automatically drops a call when the interdigit time duration exceeds 10 seconds while the system is waiting for enough digits to complete the call. This time can be disabled per station in Class of Service (Station).
- ④ At default, the 14 programmable station classes are assigned as follows:

Class 01:	Allow only 000 and 1144x calls
Class 02~14:	Allow all calls
Note : All classes deny OCC calls	

- ④ System Speed Dial can be assigned to override Code Restriction, per class (Classes 01~ 04) (default: override).
- ④ Code Restriction can be assigned for Tie line use system-wide (default: Use Code Restriction).
- ④ When Attendant Station Outgoing Lockout or Station Outgoing Lockout is set, a preprogrammed Code Restriction class is assigned (default: Class 01, Allow 000 and 1144x calls only).
- ④ The use of other common carriers (equal access) can be allowed or denied by the Code Restriction feature.
- ④ Code Restriction may be allowed or denied, per Trunk group.
- ④ When using Code Restriction with LCR, Code Restriction is applied to the digits dialled by the system.

General



- ④ Sixteen code tables can be assigned for each of the 14 remaining classes. Each code table allows eight digits to be entered.
- ④ The Recall key and Drop key cannot be used to bypass each restriction. (A Drop key is provided by programming a Feature Access Code on a Feature Access key or One-Touch key).

RELATED FEATURES LIST

Feature Number	Feature Name
A-14	Attendant Station Outgoing Lockout
C-21	CO/PBX, Tie Line Digit Restriction
S-17	Station Outgoing Lockout

GUIDE TO FEATURE PROGRAMMING

Order and Shortcut	System Data Name	Memory Block	Function	1-8-07 Attendant Page-Line Key	1-8-08 Station Page-Line Key
 +AC	* Code Restriction Class Assignment (Day Mode)	4-07			
 +AC	* Code Restriction Class Assignment (Night Mode)	4-08			
 +BN	Trunk to Tenant Assignment	2-01			
 +BCT	Trunk-to-Trunk Group Assignment	3-03			
 +BCT	Trunk Type Selection	3-91			
 +BA	PBX/CTX Access Code Assignment I	1-1-24			
 +BA	PBX/CTX Access Code Assignment II	1-1-25			
 +AC	OCC Table Assignment	1-1-67			
 +AC	OCC Table to Trunk Group Assignment	5-03			
 +AC	8-Digit Matching Table to OCC Table Assignment	1-1-68			
 +AC	8-Digit Matching Table to Normal Dial Assignment	1-1-66			
 +AC	8-Digit Matching Table to Trunk Group Assignment	5-02			
 +AC	8-Digit Matching Table Assignment	1-1-60			
 +AC	8-Digit Matching Table to Class Assignment	1-1-61			
 +AC	Code Restriction Class Allow/Deny Selection	1-1-65			
 +AC	System Speed Dial Restriction by Tenant	1-1-18			
 +AC	System Speed Dial Override by Class Selection	1-1-62			
 +AC	Tie Line Code Restriction Assignment	1-1-69			
 +AC	Code Restriction Class Assignment when Lockout is Set	1-1-70			
 +BTT	Trunk Digit Restriction	4-32			
 +BTT	Telephone to Tenant Assignment	4-09			

Order and Shortcut	System Data Name	Memory Block	Function	1-8-07 Attendant Page-Line Key	1-8-08 Station Page-Line Key
 +BTS	* Class of Service (Station) Feature Selection 2	1-8-08			3-7
 +BTT	Station to Class of Service Feature Assignment	4-17			
 +AC	CO Feature Code Service for Code Restriction	1-1-82			

* When the system is at default this Memory Block **must** be programmed for the feature to be used.

Code Restriction Password Override

C-20

FEATURE DESCRIPTION

By entering a password, the code restriction settings at a station can be overridden and dialling allowed according to new code restriction settings associated with the password which was entered. The password consists of three elements, Access Code + ID Number + ID Password. The ID password portion is optional. Entering the password changes the code restriction settings for the next call only and once that call is ended, code restrictions return to the station's normal settings.

SYSTEM AVAILABILITY

Terminal Type
All Stations.

Required Components
None.

OPERATING PROCEDURES

Entering a Password to override code restriction:

1. Lift the handset to receive internal dial tone.
2. Dial the "Code Restriction Password Override" Access Code (not set at default).
3. Dial your ID Number.
4. Dial your ID Password (optional step, depending on system programming settings).
5. If ID Number and ID Password match, a trunk is automatically seized.
6. Dial outside number.

Changing your password:

1. Lift the handset to receive internal dial tone.
2. Dial the "Set ID Password" Access Code (not set at default).
3. Dial your ID Number.
4. Enter your current ID Password (default: 0000000000).
5. Enter your new ID Password.
6. Hang up.

Confirming your password:

1. Lift the handset to receive internal dial tone.
2. Dial the "Confirm ID Password" Access Code (not set at default).
3. Dial your ID Number.
4. Current ID Password is displayed.
5. Hang up.

Resetting your password:

1. Lift the handset to receive internal dial tone.
2. Dial the "Reset ID Password" Access Code (not set at default).
3. Dial your ID Number.
4. Hang up.

SERVICE CONDITIONS

Data Assignments

- ④ Use Memory Block 1-1-19 (Automatic Outgoing Line Selection) to specify which trunk(s) are to be used when for a call made using the Code Restriction Password Override feature.
- ④ Use Memory Block 1-1-46/47/48 (2/3/4-digit Access Code Assignment) to assign access codes to the following Function Numbers.
 - 250 ID Call Originate
 - 251 DISA/ID Password Set
 - 252 DISA/ID Password Reset
 - 253 DISA/ID Password Confirmation
- ④ Use Memory Block 1-5-23 (Outgoing Mode Selection) to specify whether the Code Restriction Password Override feature (ID) or the Forced Account Code feature (TEL) is to be used (these cannot be used concurrently).
- ④ This Memory Block also specifies whether a station's Extension Number (TEL) or ID Number (ID) is to be printed in SMDR call records.
- ④ Use Memory Block 1-8-08 (Class of Service (Station) Feature Selection 2), Page 2 : LK 8, to specify DISA/ID Password Set.
- ④ Use Memory Block 1-9-00 (DISA/ID Code Assignment) to specify the ID Numbers.
- ④ Use Memory Block 1-9-02 (DISA/ID Password Selection) to specify whether or not a Password is required.

- ④ Use Memory Block 1-9-03 (ID Code Restriction Class Assignment - Day Mode) and 1-9-04 (ID Code Restriction Class Assignment - Night Mode) to specify the day and night mode code restrictions classes for each ID number.
- ④ Use Memory Block 4-26 (DISA ID Number Station Assignment) to assign the Direct Inward System Access (DISA) ID Buffer Number corresponding to the station port number.
- ④ Use Memory Block 4-27 (ID Outgoing Restriction Selection) to specify which ID Numbers can be entered to override code restriction per station.

General

- ④ A maximum of 120 ID Numbers can be assigned.
- ④ The ID Password can be from 1 to 10 digits (default: 0000000000). Once a user has entered 10 digits while setting a new ID Password, the process automatically ends and the new password is accepted. If the user goes on-hook before entering the full 10 digits, the shorter password is accepted as the new password.
- ④ Override passwords can have different access depending upon the system's mode, day or night.
- ④ Error indication is produced if a user attempts to set, verify or reset a password on a station is not assigned with this feature.
- ④ Code Restriction Override is allowed when the ID Number and ID Password match.
- ④ Whether entry of an ID Password is required or not is specified in system programming.
- ④ A desired ID Number must be assigned to a specific ID management number.
- ④ Origination of a call from a station with restriction set in terms of an ID management number (Memory Block 4-27) is denied if the call is placed in terms of the corresponding ID Number.
- ④ The procedures to originate an Override call and set an ID Password can be performed at all the stations.
- ④ The procedures to reset and confirm an ID Password can be performed at Attendant stations only.
- ④ The number of digits of the ID Number is determined by the setting of Memory Block 1-2-03 (2-, 3-, or 4-Digit Station Number Selection).
- ④ The Code Restriction Password Override feature and the Forced Account Code feature cannot be used concurrently.
- ④ The trunk selection in Memory Block 1-1-19 (Automatic Outgoing Line Selection) are only used when an Override call is originated.

- ④ When an Override call is originated, the code restriction settings in MB 1-9-03 and MB 1-9-04 take precedence over the settings in MB 4-07 and MB 4-08, for the next call only.
- ④ Code restriction settings revert to those assigned in MB 4-07 and MB 4-08 once the call is ended.
- ④ The ID Number will be printed in SMDR records in place of the Extension Number feature when this is used.
- ④ When the Code Restriction Password Override feature is used to make an outgoing call from a telephone assigned with ACR, ACR is bypassed for that call and a trunk is selected according to MB 1-1-19.
- ④ When the system is operating in ID mode (Memory Block 1-5-23 = ID), to ensure Trunk to Trunk transfer calls indicate correctly in the SMDR records, you must apply one of the following:
 1. In MB 1-9-00, assign 999 to an unused ID number.
 2. In MB 1-4-04, enter one of the ID numbers you have assigned in MB1-9-00.

Note: Note that if the Trunk Transfer is completed before the outgoing call is answered (or the call duration timer has started), the SMDR records will show the EXT or ID number assigned in MB 1-4-04, not the EXT or ID number of the station transferring the call.

CO/PBX, Tie Line Digit Restriction

C-21

FEATURE DESCRIPTION

The CO/PBX, Tie Line Digit Counting feature restricts the number of digits that can be dialed from a station on an outside line. This can be used to eliminate unauthorised calls.

SYSTEM AVAILABILITY

Terminal Type
All stations.

Required Components
None.

OPERATING PROCEDURES

Not applicable.

SERVICE CONDITIONS

Data Assignment

- ☎ The maximum number of digits is determined in System Programming, per station [01~99 digits or No Restriction (default assignment)].





General

- ☎ Digits 0~9, **Redial**, and # are counted as digits dialed; pauses are not counted.
- ☎ When the outside line is released, the digit counter is reset.
- ☎ Press the Recall or Drop key to reset the digit counter. (A Drop key is provided by programming a Feature Access Code on a Feature Access key or One-Touch key.)
- ☎ When Feature Access or One-Touch key (programmed for hookflash) is pressed, the digit counter is reset.
- ☎ If System Speed Dial is set to override Code Restriction, CO/PBX Tie Line Digit Restriction is not applied.
- ☎ Single Line Telephone users cannot be restricted by CO/PBX, Tie Line Digit Counting after the PBR is released because the DTMF dial signals are sent to the outside line from the Single Line Telephone.
- ☎ When the outside line is put on hold, the digit counter retains the number of digits dialed. When a station user picks up the held line, digit counting continues.
- ☎ Code Restriction must be assigned to the station before this feature is used.

RELATED FEATURES LIST

Feature Number	Feature Name
C-19	Code Restriction

GUIDE TO FEATURE PROGRAMMING

Order and Shortcut	System Data Name	Memory Block	Function	1-8-07 Attendant Page-Line Key	1-8-08 Station Page-Line Key
 +BTT	* Trunk Digit Restriction	4-32			
 +AC	* Code Restriction Class Assignment (Day Mode)	4-07			
 +AC	* Code Restriction Class Assignment (Night Mode)	4-08			
 +AC	Tie Line Code Restriction Assignment	1-1-69			

* When the system is at default this Memory Block **must** be programmed for the feature to be used.

Computer Telephony Integration (CTI)

C-22

FEATURE DESCRIPTION

CTI is an advanced terminal feature that allows a PC and its TAPI compliant software application to connect to the Xen IPK system. The Xen IPK system provides all station information to the PC, called a CTI Terminal, that it normally provides to a digital Multiline Terminal. The synergy provided by the CTI Terminal and Xen IPK system is limited only by the software application running on the CTI Terminal. Automatic Data Lockup, Screen Popups, PC Attendant Consoles, and Directory Dialling are examples of these software applications.

CTI is implemented using a Computer Telephony Adapter and RS-232C, and USB CTI interfaces are available for D^{term} Series i and DTU-type multiline terminals.

SYSTEM AVAILABILITY

Terminal Type

All D^{term} Series i and DTU-type multiline terminals, except DTR-2DT-1A.

Required Components

D^{term} Series i CT(A)-R() Unit or CT()-R() Unit.

DTU-type CTA-U() Unit or CTU(S)-U() Unit.

OPERATING PROCEDURES

Refer to the CTI product literature.

SERVICE CONDITIONS

- ④ The CT(A)-R() Unit connects to the bottom of any Dterm Series i Multiline Terminal except DTR-2DT-1A TEL or the CTA-U() Unit connects to the bottom of any DTU-type Multiline Terminal to provide an RS-232 interface that connects to a PC running a TAPI-compliant application.
- ④ The CT(U)-R() Unit connects to the bottom of any Dterm Series i Multiline Terminal except DTR-2DT-1A TEL or the CTU(S)-U() Unit connects to the bottom of any DTU-type Multiline Terminal to provide a USB interface that connects to a PC running a TAPI-compliant application.

THIS PAGE INTENTIONALLY LEFT BLANK

Consecutive Speed Dial

C-23

FEATURE DESCRIPTION

The Consecutive Speed Dial feature provides for the use of System Speed Dial, Station Speed Dial, and manual dialling for all stations consecutively. Complicated dialling sequences are simplified. This feature eases access to secondary common carriers, credit card verification, and any application that requires entry of groups of numbers such as authorisation codes or customer numbers.

SYSTEM AVAILABILITY

Terminal Type

All Multiline Terminals.

Required Components

None.

OPERATING PROCEDURES

To use this feature from a Multiline Terminal:

1. Lift the handset or press . Receive a dial tone.
2. Use any combination of manual dialling, Station Speed Dial, and System Speed Dial.

SERVICE CONDITIONS

General

- ① A maximum of 24 digits can be stored in Multiline Terminal Speed Dial buffers. Pause, hookflash, #, and  count as digits when stored in speed dial buffer.
- ① When using Single Line Telephones, only manual dialling sequences can follow a Station or System Speed Dial sequence.

THIS PAGE INTENTIONALLY LEFT BLANK

Cordless Telephone Connection

C-24

FEATURE DESCRIPTION

With an AP(R) or AP(A) Adapter installed, a cordless telephone can be connected to a Multiline Terminal. System Programming defines whether or not the cordless telephone rings when calls are directed to the Multiline Terminal associated with it. The SLI(8)-U() ETU also supports cordless telephones, but this feature refers to Multiline Terminal cordless connection.

SYSTEM AVAILABILITY

Terminal Type

D^{term} Series i Multiline Terminal with AP(R)-R() Unit or AP(A)-R() Unit.
DTU-type Multiline Terminal with APR-U() Unit.

Required Components

Analogue cordless Single Line Telephone.

OPERATING PROCEDURES

To make a call from a cordless Single Line Telephone:

1. Go off-hook.
2. Dial the station number or dial the Trunk Access Code and telephone number.

To answer a call from a cordless Single Line Telephone:

When the Multiline Terminal is ringing, the incoming call can be answered by the cordless Single Line Telephone user by going off-hook, when ringing line preference is assigned for the Multiline Terminal.

To transfer a call from a cordless Single Line Telephone to its associated Multiline Terminal:

1. Multiline Terminal user goes off-hook.
2. Single Line Telephone user goes on-hook (at this time, the call is automatically connected to the Multiline Terminal).

To transfer a call from a Multiline Terminal to its associated cordless Single Line Telephone:

1. Single Line Telephone user goes off-hook (at this time, the call is automatically connected to the Single Line Telephone).
2. Multiline Terminal user goes on-hook.

To use Hookflash:

Refer to operation for Single Line Telephone Access.

**SERVICE
CONDITIONS****Data Assignment**

- ④ Use Memory Block 4-39 (APR Ring Mode Assignment) to specify NON (no ring), STA (ring Station Number only), or ALL (ring all stations) for SLTs connected to the APR/PA Adapter for the cordless telephone. Default is STA.
- ④ Use Memory Block 4-59 (APR Hookflash selection) to allow or deny Hookflash on an APR/PA Adapter.

Restrictions

- ④ A voice announced internal call to the Multiline Terminal does not ring the cordless telephone.
- ④ Only one cordless Single Line Telephone can be connected to an APR/PA Adapter.
- ④ When CO Prime Line is assigned to the associated Multiline Terminal, internal dial tone cannot be transferred to the cordless telephone.
- ④ The cordless telephone requires a PBR circuit while dialling. When all PBR circuits are busy, a busy tone is heard when the phone goes off hook.

General



- ④ This feature works with analogue cordless Single Line Telephones.
- ④ System Programming determines whether the cordless telephone rings when any call is directed to the associated Multiline Terminal, rings only for Tie/DID, DIT/ANA, and internal calls, or does not ring.
- ④ The following are not supported for cordless telephones: disconnect signal, DTMF sending (to cordless telephone), Message Wait, and DP-type cordless telephones.
- ④ A maximum of 120 APR/APA Adapters can be installed in Multiline Terminals on the Xen IPK Expanded system, or a maximum of 32 on the Xen IPK Basic system.
- ④ The Multiline Terminal user and its associated cordless telephone user cannot talk to each other.

- ④ The Multiline Terminal LCD displays normal information for Multiline Terminal when a cordless terminal is used.
- ④ If the Multiline Terminal user goes off-hook before the cordless Single Line Telephone user, a PBR circuit is not connected for the cordless Single Line Telephone.
- ④ The cordless telephone must be installed within 3 metres of the APR/ APA Adapter.
- ④ A Hookflash can be sent from a cordless telephone connected to an APR/APA Adapter. This provides the additional ability to transfer calls or place calls on hold within the Xen IPK System and access various intercom features.

RELATED FEATURES LIST

Feature Number	Feature Name
A-7	Ancillary Device Connection

GUIDE TO FEATURE PROGRAMMING

Order and Shortcut	System Data Name	Memory Block	Function	1-8-07 Attendant Page-Line Key	1-8-08 Station Page-Line Key
 +BTM	APR Ring Mode Assignment	4-39			
 +AU	APR/APA Hookflash Selection	4-59			

THIS PAGE INTENTIONALLY LEFT BLANK

FEATURE DESCRIPTION

A station with Do Not Disturb set can select a Customised Message that is displayed at any other Multiline Display Terminal when an internal call is made to the DND station. The message remains displayed on the LCD of the Multiline Terminal where the message was set. Ten different messages can be set in System Programming.

SYSTEM AVAILABILITY

Terminal Type

All Multiline Terminals equipped with an LCD.

Required Components

None.

OPERATING PROCEDURES

To set a message from a Multiline Terminal:

1. Press **[Feature]**.
2. Dial Access Code **7 0**.
3. Press ***** to select a message. Continue pressing ***** to scroll through the possible messages.
4. Press **#**, and enter date and time. (Date and time are optional.)
5. Press **[Feature]**.
6. Set Do Not Disturb.

To receive a message at a Multiline Terminal with a LCD:

1. Lift the handset, and receive internal dial tone.
2. Dial the desired station number that has Customised Message set.
3. A message is received on the LCD from the station that was called.

To cancel a message from a Multiline Terminal:

1. Press **Feature**.
2. Dial **7** **9**.
3. Press **Feature**.



**SERVICE
CONDITIONS****Data Assignment**

- ⓘ A maximum of 10 messages can be programmed in System Programming.

General

- ⓘ Six messages are provided in default, however, all 10 can be programmed.
- ⓘ Default messages are as follows:
 - Don't Disturb
 - Meeting
 - Business Trip
 - Not In
 - With Guest
 - Out of Office
- ⓘ The message remains displayed on the LCD of the Multiline Terminal where the message was set.
- ⓘ This feature is programmable for Multiline Terminals in Class of Service assignments.
- ⓘ When this feature is set, the Feature LED flashes.
- ⓘ A maximum of 13 characters and the return time can be set for each message.
- ⓘ Don't Disturb must be set to display the message.
- ⓘ When calling a station in Do Not Disturb mode, a message displays on the caller terminal. Three seconds later, the return date and time are displayed.

GUIDE TO FEATURE PROGRAMMING

Order and Shortcut	System Data Name	Memory Block	Function	1-8-07 Attendant Page-Line Key	1-8-08 Station Page-Line Key
 +BI	Customised Message 1~10 Assignment	1-2-09~18			
 +BTS	Class of Service (Station) Feature Selection 2	1-8-08			1-1, 2-1
 +BTT	Station to Class of Service Feature Assignment	4-17			

THIS PAGE INTENTIONALLY LEFT BLANK

Data Line Security

D-1

FEATURE DESCRIPTION

The Data Line Security feature protects any station port from receiving audible tones (such as Camp-On or Override tones) and denies a station from barging in while busy. It prevents disruption of data transmission when using a modem or fax (facsimile) machine.

SYSTEM AVAILABILITY

Terminal Type

All terminals.

Required Components

None.

OPERATING PROCEDURE

Not applicable.

SERVICE CONDITIONS

Data Assignment

- This feature is assigned, per station, via System Programming.



General

- When a Multiline Terminal is assigned for Data Line Security, a Tone Override and call alert notification tone are not heard from the handset; however, the Tone Override and call alert notification tone are sent and heard from the speaker when the Multiline Terminal is off hook.
- A Single Line Telephone connected to an SLI(8)-U() ETU or an SLT(1)-U() ADP, with Data Line Security assigned, rings at a rate of 1 second ON/2 seconds OFF for any ringing or transferred call.
- The ringing pattern of a Single Line Telephone, connected to an AP(R)-R() Unit, does not change when Data Line Security is assigned.
- Data Line Security protects a station from Barge-In, even if Barge-In is allowed in Class of Service.

RELATED FEATURES LIST

Feature Number	Feature Name
C-1	Call Alert Notification
C-17	Class of Service

GUIDE TO FEATURE PROGRAMMING

Order and Shortcut	System Data Name	Memory Block	Function	1-8-07 Attendant Page-Line Key	1-8-08 Station Page-Line Key
 +BTT	* SLT Data Line Security Assignment	4-90			
 +BTS	Class of Service (Station) Feature Selection 2	1-8-08			3-8
 +BTT	Station to Class of Service Feature Assignment	4-17			

* When the system is at default this Memory Block **must** be programmed for the feature to be used.

Delay Announcement

D-2

FEATURE DESCRIPTION

The Delay Announcement feature activates when an incoming call to an Automatic Call Distribution (ACD) or Uniform Call Distribution (UCD) group encounters all ACD/UCD stations busy or receives no answer within a preprogrammed time. The call is queued and receives a recorded announcement after a predetermined time. Multiple Delay Announcements (first and second) are available. The incoming call type can be Direct Inward Termination (DIT/ANA), CO Ring Transfer, Automated Attendant Transfer, or DID/Tie line.

SYSTEM AVAILABILITY

Terminal Type

Not applicable.

Required Components

VRS(4)-U() ETU is required for recorded announcement

MIFA-U() ETU is required for Uniform Call Distribution (UCD)

MIFA-U() ETU and KMA()UA are required for Automatic Call Distribution (ACD)

OPERATING PROCEDURES

To record a Delay Announcement:

Refer to A-18 Automated Attendant, for these instructions.

To process an incoming call:

1. An incoming call to an ACD/UCD group is received.
2. The First Delay Announcement answers the caller.
3. After the message, the call is connected to Music on Hold.
4. The Second Delay Announcement answers the caller after a programmed time.
5. After the message, the call is connected to Music on Hold again.
6. The Second Delay Announcement answers the caller again after a programmed time.
7. Steps 5 and 6 continue until the caller is answered by an Agent in the ACD/UCD group.

SERVICE CONDITIONS

Data Assignment

- ④ The announcements each have predetermined programmable times. Each Delay Announcement Start Timer and Release Timer are also programmable.
 1. First Delay Announcement, number of repetitions/times (1~8 times).
 2. Time between First and Second Delay Announcement [default: 20 sec. (0~60 sec., Infinity)].
 3. Second Delay Announcement, number of repetitions/times (1~8 times).
 4. Time between Second Delay Announcement and repeat of Second Delay Announcement [default: 20 sec.(0~60 sec., Infinity)].
- ④ The Delay Announcement feature is programmed, per trunk.













General

- ④ DIT/ANA, CO Ring transfers, Automated Attendant Transfers, and DID/Tie line calls must be directed to the ACD/UCD Pilot number to receive Delay Announcement.
- ④ If all Delay Announcement circuits are busy, the incoming caller continues to hear ringback tone or Music on Hold until a Delay Announcement circuit is available.
- ④ A maximum of two VRS(4)-U() ETUs can be installed in the Xen IPK system.
- ④ A maximum of four calls can be connected to a single VRS(4)-U() ETU at the same moment.
- ④ Each caller hears every announcement from the beginning.
- ④ When an ACD/UCD Agent becomes available, the caller is immediately connected to the Agent, even if a recorded announcement is in progress.
- ④ This feature provides eight channels of two Delay Announcements. All four ACD/UCD groups share the two Delay Announcements.

RELATED FEATURES LIST

Feature Number	Feature Name
A-20	Automatic Call Distribution (ACD)
U-1	Uniform Call Distribution (UCD)

GUIDE TO FEATURE PROGRAMMING

Order and Shortcut	System Data Name	Memory Block	Function	1-8-07 Attendant Page-Line Key	1-8-08 Station Page-Line Key
 +BS	Card Interface Slot Assignment	7-1			
 +AR	* VRS Message Recording Time Selection	1-8-12			
 +AR	* VRS Message Function Assignment	1-8-13			
 +BA	* Access Code (1-, 2-, 3-Digit) Assignment	1-1-46/47/48	501		
 +BTS	Class of Service (Station) Feature Selection 2	1-8-08			2-6
 +BTT	Station to Class of Service Feature Assignment	4-17			
 +AR	* Delay Announcement Assignment	3-41			
 +AR	First Delay Announcement Start Time Selection	1-1-71			
 +AR	First Delay Announcement Repeat Selection	1-1-72			
 +AR	First to Second Delay Announcement Interval Time Selection	1-1-73			
 +AR	Second Delay Announcement Repeat Selection	1-1-74			
 +AR	Second Delay Announcement Repeat Interval Time Selection	1-1-75			

* When the system is at default this Memory Block **must** be programmed for the feature to be used.

THIS PAGE INTENTIONALLY LEFT BLANK

Delayed Ringing

D-3

FEATURE DESCRIPTION

The Delayed Ringing feature allows a secondary answering positions to ring on incoming calls after a programmed time interval. This feature applies to CO/PBX lines, Secondary Incoming Extensions, and Call Arrival Keys.

SYSTEM AVAILABILITY

Terminal Type

All terminals.

Required Components

None.

OPERATING PROCEDURES

To process an incoming call:

1. Receive delayed incoming ring.
2. Answer the call in the standard manner.

SERVICE CONDITIONS

Data Assignment

- ⓘ The time interval between the detection of an incoming call and the start of Delayed Ringing is programmable in system data in increments of one second. Default values are:
 - Outside call = 15 seconds
 - Internal call = 10 seconds
- ⓘ Tenant Ringing conflicts are resolved by programming Trunk-to-Tenant Assignment. The lower numbered tenant that is assigned is used as the ringing control.

General













- ⓘ The following incoming calls support Delayed Ringing:
 - Normal incoming CO/PBX ringing.
 - DIT/ANA, internal calls to Secondary Incoming Extension, and Call Arrival Keys.
 - Incoming DID/Tie line calls.
 - DID/Tie line/Automated Attendant calls that convert to normal CO ringing calls.
 - Incoming outside lines that appear at the Attendant Add-On Console.

- ④ Single Line Telephone users can receive CO/PBX Delayed Ringing.
- ④ Delayed Ringing is provided to a terminal that is off-hook and is assigned for Off-Hook Ringing.
- ④ Single Line Telephones assigned Delay Ringing follow Station Hunting.
- ④ When a CO line is assigned DIT/ANA to a station that also has Delay Ringing assigned, the DIT/ANA does not occur until the Delay Ringing Timer expires.

RELATED FEATURES LIST

Feature Number	Feature Name
C-17	Class of Service
F-4	Flexible Numbering Plan

GUIDE TO FEATURE PROGRAMMING

Order and Shortcut	System Data Name	Memory Block	Function	1-8-07 Attendant Page-Line Key	1-8-08 Station Page-Line Key
 +BN	Trunk to Tenant Assignment	2-01			
 +BTM	Line Selection for Telephone Mode	4-12			
 +BTT	* CO/PBX Ring Assignment (Day Mode)	4-01			
 +BTM	Extension Line Key Ring Assignment (Day Mode)	4-37			
 +BTT	* CO/PBX Ring Assignment (Night Mode)	4-02			
 +BTM	Extension Line Key Ring Assignment (Night Mode)	4-38			
 +BCM	Delayed Ringing Time Assignment (CO)	1-1-77			
 +BI	Delayed Ringing Time Assignment (ICM)	1-2-26			
 +AU	Automated Attendant Transfer Delayed Ringing Time Selection	1-4-02			
 +ALM	Tie/DID Line Delay Ringing Time Selection	1-1-07			
 +ALN	Tie/DID Line Delay Ring Pattern Selection	1-1-53			
 +BM	CO/PBX Incoming Ringing Alarm Time Selection	1-1-06			

* When the system is at default this Memory Block **must** be programmed for the feature to be used.

Dial 9 For Attendant

D-4

FEATURE DESCRIPTION

Stations can access a system Attendant Position by dialling 9.

SYSTEM AVAILABILITY

Terminal Type



All terminals.

Required Components

None.

OPERATING PROCEDURES

To use this feature from a Multiline Terminal:





1. Lift the handset or press  and receive internal dial tone.
2. Dial  to call the Attendant (set at default).
3. Lift the handset to talk with Attendant.

To use this feature from a Single Line Telephone:

1. Lift the handset, and receive internal dial tone.
2. Dial  to call the Attendant (set at default).
3. Talk with the Attendant.

SERVICE CONDITIONS



General

-  Any station can be called by dialling 9 (default: All stations call station 100).
-  The Attendant can also be called by dialling the applicable station number.
-  The system can have multiple Attendants. Only one can be called by dialling 9. If that Attendant dials 9, an error tone is received.
-  When dialling a busy Attendant and receiving call waiting tone, the Step Call feature can be used to advance to an idle station.

**RELATED
FEATURES LIST**

Feature Number	Feature Name
A-11	Attendant Add-On Console
A-13	Attendant Positions

**GUIDE TO
FEATURE
PROGRAMMING**

Order and Shortcut	System Data Name	Memory Block	Function	1-8-07 Attendant Page-Line Key	1-8-08 Station Page-Line Key
 +BA	Access Code (1-Digit) Assignment	1-1-46	176		
 +BA	Specified Station Access Code Assignment	1-2-08			

Dialled Number Identification Service (DNIS)

D-5

FEATURE DESCRIPTION

The Dialled Number Identification Service (DNIS) feature allows the display of name, extension number and caller ID (if available) for an incoming DID call.

SYSTEM AVAILABILITY

Terminal Type

All Multiline terminals.

Required Components

DID(4)-U() ETU (Cannot display Caller ID)

TLI(2)-() ETU (Cannot display Caller ID)

PRT(1)-U() ETU (Can display Caller ID if subscribed and programmed)

BRT(4)-U() ETU (Can display Caller ID if subscribed and programmed)

OPERATING PROCEDURES

Not applicable.

SERVICE CONDITIONS

General

- ⓘ DNIS is always displayed in the center line of the LCD.
- ⓘ DNIS is displayed for an incoming MIF ACD/UCD and SCD calls.
- ⓘ During Call Forward - All Call, Busy, No Answer, or Busy/No Answer, the incoming DID call terminates, and the forwarding extension number is not displayed, but DNIS is displayed on the Center row of the LCD of the forwarding destination.

Restrictions









- ⓘ A maximum of eight characters can be used to assign the DNIS name in Memory Block 1-1-22 (DID Digit Conversion Table).
- ⓘ A DNIS name can be assigned for a maximum of 200 DID numbers. The name applies for both Day and Night Mode conversion.
- ⓘ To enter a name, refer to Dial Pad Character Assignment table shown under S-11, Speed Dial Stored Characters.
- ⓘ During call termination, Feature + Line Key, Feature + CAR, or Feature + Answer key combination cannot be used to enable the DNIS display.
- ⓘ DNIS is displayed only during call termination. It cannot be displayed during the conversation by pressing the extension key or CAP key. Caller ID is displayed according to system programming.













- ④ When a forwarding destination is set with Memory Block 1-1-23 (DID Forward Station Number for Busy Station or Undefined digit), DNIS is displayed only when the forwarding destination is busy. DNIS is not displayed when the call is forwarded with an undefined digit.
- ④ DNIS is not displayed for incoming ACD Plus calls.
- ④ If two row Caller ID display is enabled, DNIS will block the second row caller ID information from being seen. In this case, Caller ID display can be programmed to swap the position of the name and number, depending on which one is required to be seen at the top (Memory Block 1-8-08, Class of Service [Station] Selection, Page 4, Line Key 4).

RELATED FEATURES LIST

Feature Number	Feature Name
D-9	Direct Inward System Access (DISA)
I-8	ISDN-PRI Trunk Connections
T-1	Tandem Switching of 4-Wire E&M Tie Lines
T-2	Tenant Service

GUIDE TO FEATURE PROGRAMMING

Order and Shortcut	System Data Name	Memory Block	Function	1-8-07 Attendant Page-Line Key	1-8-08 Station Page-Line Key
 +BS	Card Interface Slot Assignment	7-1			
 +BS	* Station Number Assignment	4-10			
 +BK	Call Arrival Key Block Assignment	1-2-04			
 +BCT	Trunk Type Selection	3-91			
 +ALN	Digit Add/Del for Tie Line Networking Assignment	5-00			
 +ALN	* DID Digit Length Selection	1-1-20			
 +ALN	* DID Digit Conversion Assignment	1-1-21			
 +ALN	* DID digit Conversion Table	1-1-22			
 +ALN	DID Forward Station Number for Busy station or Undefined Digit	1-1-23			

Order and Shortcut	System Data Name	Memory Block	Function	1-8-07 Attendant Page-Line Key	1-8-08 Station Page-Line Key
 +BTS	* Class of Service (Station) Feature Selection 2	1-8-08			4-3,4-4, 5-7
 +AI	Caller ID Display Assignment for System Mode	1-1-78			
 +AI	Caller ID Display for CAR Key Assignment	4-49			
 +BTT	Station to Class of Service Feature Assignment	4-17			
 +BTT	Telephone to Tenant Assignment	4-09			
 +BN	Line Key Selection	2-05			
 +BN	Line Key Selection for Tenant Mode	2-06			
 +BTM	Line Key Selection for Telephone Mode	4-12			
 +BTT	CO/PBX Ring Assignment (Day Mode)	4-01			
 +BTT	CO/PBX Ring Assignment (Night Mode)	4-02			
 +BTM	Extension Line Key Ring Assignment (Day Mode)	4-37			
 +BTM	Extension Line Key Ring Assignment (Night Mode)	4-38			

* When the system is at default this Memory Block **must** be programmed for the feature to be used.

THIS PAGE INTENTIONALLY LEFT BLANK

Digit Insertion

D-6

FEATURE DESCRIPTION

The Digit Insertion feature provides user friendly operation when the system is installed behind a PBX or Centrex Central Office. When a system user originates an outgoing call, the system automatically inserts the PBX/Centrex Trunk Access Code. This feature saves the user from dialling an additional Access Code.

SYSTEM AVAILABILITY

Terminal Type

All terminals.

Required Components

None.

OPERATING PROCEDURES

To make a call using Digit Insertion





1. Lift the handset, and receive internal dial tone.
2. Dial the Trunk Access Code, then dial the desired telephone number.

SERVICE CONDITIONS

General

- ④ The Trunk Access Code of the Xen IPK should be the same number as the Trunk Access Code of the PBX/Centrex.
- ④ An outside call by Digit Insertion feature complies with Code Restriction.
- ④ Digit Insertion can be assigned per Trunk group.
- ④ Digit Insertion can be assigned to a maximum of 16 Trunk groups.
- ④ When an outside call is originated by pressing a CO/PBX line key, a digit is not inserted.
- ④ A Trunk Access Code can be programmed as 1, 2, or 3 digits.
- ④ When a station user originates an outside call using the Digit Insertion feature, the Least Cost Routing (LCR) feature cannot be accessed.
- ④ A maximum of 10 digits can be inserted.

GUIDE TO FEATURE PROGRAMMING

Order and Shortcut	System Data Name	Memory Block	Function	1-8-07 Attendant Page-Line Key	1-8-08 Station Page-Line Key
 +BA	* Access Code (1-, 2-, 3-Digit) Assignment	1-1-46/47/48	401 ~ 416		
 +BCT	Trunk-to-Trunk Group Assignment	3-03			
 +BCS	* Networking Trunk Group/Route Advance Assignment	1-1-49			
 +BCS	* CO/PBX Outgoing Digit Add Assignment	1-1-50			

* When the system is at default this Memory Block **must** be programmed for the feature to be used.

FEATURE DESCRIPTION

The VMS(2/4/8)-U() ETU or FMS(2/4)-U() ETU provides Digital Voice Mail Service, Automated Attendant (AA), Audiotext, Fax Detection, Message Notification, Live Recording and Live Monitoring. The VMS(2/4/8)-U() ETU and FMS(2/4)-U() ETU are complete voice mail applications (XenMail) built on a single ETU. This method has advantages that include tighter application integration and built-in battery backup for the complete system.

Descriptions are as follows:

Voice Mail Service

Voice Mail allows a caller to leave a recorded message in their voice and exact words for another individual.

Automated Attendant

The Automated Attendant answers a call, determines the extension, and transfers the call to that extension.

Audiotext

Audiotext provides around the clock information and allows an organisation to present it with natural voice, music, or whatever they want callers to hear.

Fax Detect Routing and Notification

Incoming faxes are detected and automatically delivered to a fax machine. When using the fax machine handset, the fax originator can record a voice message which can be sent to the attendant.

Live Recording

Live Recording simplifies Message and note taking by permitting all or a portion of the conversation in progress to be recorded.

Live Monitoring

Live Monitoring allows a station user to listen to a caller leaving a voice mail message. Audio is provided through the Multiline Terminal speaker. The station user can pick up the handset and answer the call anytime during the recording.

 Available on the VMS()-U() ETU only. Refer to L-4 Live Monitoring on page 399.

SYSTEM AVAILABILITY

Terminal Type

All stations (available for all features except Live Recording).

Multiline Terminals (available for all features).

Required Components

VMS(2/4/8)-U() ETU

FMS(2/4)-U() ETU

OPERATING PROCEDURES

To program the Feature Access key for Live Recording from a Multiline Terminal

1. Press **Feature**.
2. Press **Redial**.
3. Press the Feature Access key.
4. Dial **2**.
5. Dial the Live Record feature code.

Feature codes are:

- 0 0** = Record
- 0 1** = Pause
- 0 2** = Rerecord
- 0 3** = Erase
- 0 4** = End
- 0 5** = Urgent Page
- 0 6** = Address
- 0 7** = Live Monitoring

6. Press **Feature**.

To program a One-Touch key for Live Recording from a Multiline Terminal

1. Press **Feature**.
2. Press **Redial**.
3. Press One-Touch key.
4. Dial **2**.

- Dial the Live Recording feature code.

Feature codes are:

- 0 0 = Record
- 0 1 = Pause
- 0 2 = Rerecord
- 0 3 = Erase
- 0 4 = End
- 0 5 = Urgent Page
- 0 6 = Address

- Press **Feature**.

To set up personal mailboxes

- Lift handset and receive an internal dial tone.
- Dial Voice Mail extension (wait for main greeting).
- Dial 0 and the extension number.
- Follow the verbal instructions to personalize the mailbox.

DIGITAL VOICE MAIL MESSAGES

To retrieve message from a Multiline Terminal or a Single Line Telephone

- Go off-hook; receive internal dial tone.
- Dial the assigned station number to access Voice Mail.
- Follow the verbal instructions provided by the XenMail system.
- Press Easy Message Access key.
- Follow the verbal instructions to program the One-Touch key.

To program a One-Touch key for easy message access

- Press **Feature**.
- Press **Redial**.
- Press One-Touch key.
- Dial 1, followed by Voice Mail extension number.
- Press **Feature**.

LIVE RECORDING

To record an incoming CO/PBX conversation using Automatic Live Recording:

1. To record an incoming CO/PBX conversation, go off-hook to answer the call or, to record an outgoing CO/PBX conversation, place the call on hold and retrieve the call. Live Recording automatically starts. RECORD is displayed in the lower section of the LCD on a Multiline Terminal.
2. To store the recorded conversation in a different mailbox, dial a mailbox number or press a One-Touch key or Feature Access key programmed with the mailbox number. RECORD XXXXXX is displayed in the lower section of the LCD on a Multiline Terminal. (XXXXXX is the station name/number where the conversation is stored)

Note: Be sure to inform the outside party that their conversation is being recorded.

To record a CO conversation in progress using Manual Live Recording:

1. Press the Feature Access key programmed as the Record key. The Record key flashes red when Live Recording begins and flashes green when the Live Recording is addressed. RECORD is displayed in the lower section of the LCD on a Multiline Terminal.
2. To store the recorded conversation, dial a mailbox number or press a One-Touch key or Feature Access key programmed with the mailbox number. RECORD XXXXXX is displayed in the lower section of the LCD on a Multiline Terminal. (XXXXXX is the station name/number where the conversation is stored)

SERVICE CONDITIONS

Digital Voice Mail

General

- ④ A VMS(2/4/8)-U() ETU or FMS(2/4)-U() ETU, must be installed to provide Digital Voice Mail.
- ④ The Xen IPK system supports up to 32 digital voice mail ports.
- ④ All Multiline Terminals (with or without an LCD) and Single Line Telephones (with a Message Wait Lamp) receive an indication that a Voice Mail message is waiting.
 - Multiline Terminals equipped with an LCD receive a message in the LCD indicating a message is waiting.
 - The Large LED and Feature LED flashes red to indicate a message is waiting on all Multiline Terminals.
 - Single Line Telephones supported by an SLI(8)-U() ETU light the Message Wait Lamps to indicate a message is waiting.

- ④ A Feature Access key or One-Touch key can be assigned for easy message access.
- ④ If a call transferred from a Voice Mail port is not answered in three minutes (fixed timer), the call recalls to the Voice Mail port.
- ④ If a station is programmed for multiple Call Forward (e.g., 100 CFWD - 101 CFWD - VM Hunt Group) and a call is made to station 100, the caller is forwarded to the mailbox for station 100.
- ④ Voice Mail Message Waiting can be set/cancelled only from a Voice Mail port.
- ④ The Digital Voice Mail recognises the CO/PBX busy tone.
- ④ Refer to S-14 Station Hunting for specific information about station hunt groups.
- ④ The following major features are provided:
 - Voice Mail Service
 - Automated Attendant
 - Audiotext
 - Fax Detect, Routing and Notification
 - Optional Multilingual Prompts

Live Recording

General

- ④ Tone Override, Call Alert, Barge-In, Camp-On, and Voice Over Split feature tones are denied during Live Recording.
- ④ If a Multiline Terminal user completes the Live Recording without specifying a mailbox where the conversation should be stored and Automatic Recall is not assigned in Digital Voice Mail programming, the conversation is stored in the mailbox assigned to the Multiline Terminal. When a Multiline Terminal user completes the Live Recording without specifying a mailbox where the conversation should be stored and Automatic Recall is assigned in Digital Voice Mail programming, the conversation is stored in the mailbox assigned to the Multiline Terminal and the system recalls the Multiline Terminal and plays the recorded conversation.
(Auto Callback rings - 4 times, Waiting Time - 3 minute, Redial - 5 times.)
- ④ Live Recording can be used only from Multiline Terminals.
- ④ Individual trunks must be assigned for the Live Recording feature to operate.

- ④ An alert tone is provided for Live Recording. The alert tone is heard by both the outside party and the Multiline Terminal user when the recording starts or at specified intervals during recording. The interval between alert tones is assigned in the Digital Voice Mail System Programming. The tone lasts for 0.5 seconds. The system can also be programmed so that an alert tone is not provided.
- ④ Up to seven feature keys can be programmed for use with Live Recording. These feature keys can be assigned to Feature Access keys, One-Touch keys, or DSS keys (on a DSS/BLF console). If the feature keys are assigned to One-Touch keys, no LED indications are provided.
- ④ The following feature keys can be programmed:

Record Key

Use this key to manually start Live Recording. The associated LED flashes red while recording. The associated LED goes off when recording ends or a pause occurs and flashes green when a live recorded message is addressed.

Pause Key

Use this key to pause and restart live recording. The associated LED flashes green when recording has paused.

Erase Key

Use this key to erase the live recorded conversations. After the Erase key is pressed, the Voice Mail port remains off-hook until the call is terminated.

End Key

Use this key to end the live recording. The conversation can continue without being recorded.

Rerecord Key

Use this key to erase a recorded conversation while recording is in progress and restart a new recording.

Urgent Page Key

Use this key to change the Live Recording assignment from dial out to pager. (Message Notification to Pager Assignment turns ON/OFF when this key is pressed while recording.)

Address Key

Use this key to confirm Live Recording, erase Live Recording, change the mailbox number where Live Recording is stored, or add a recorded prelude to a recorded conversation.

- ④ During each Live Recording, a conference circuit is used.
- ④ Live Recording is not allowed if sixteen Add-On Conference circuits are being used.
- ④ Additional internal parties cannot be added to a live recorded conversation via conferencing.

- ④ Only CO/PBX, Tie, and DID calls can be recorded using Live Recording. Internal calls cannot be recorded by the Live Recording feature.
- ④ The Record key LED is on when all conference circuits or all Digital Voice Mail ports are busy.
- ④ Any station user can direct a live recorded message to another station user.
- ④ Any Multiline Terminal can change the Message Notification mode to Pager Notification mode by first directing a live recorded message to another station and then pressing the Urgent Page key. The station that is put into the Urgent Page mode must have a pager telephone number assigned.
- ④ An * is displayed in the far right corner of the lower LCD when a Multiline Terminal (with LCD) is in Pager Notification mode.
- ④ D^{term} Series i Multiline Terminals that have separate "Message" button will access the extension number programmed in Memory Block 1-8-26.

CAUTION

















Using Live Recording feature to eavesdrop or record sound activities at the other end of the telephone line may be illegal under certain circumstances and laws. Consult a legal advisor before implementing any practice to monitor or record a telephone conversation. Some federal and state laws require a party monitoring or recording a telephone conversation to use a beep-tone(s), notify all parties to the telephone conversation, and/or obtain consent of all parties to the telephone conversation. To monitor or record sound activities at the other end of the telephone line using the Live Recording feature, the sound of the alert tone at the beginning of the Live Recording may or may not be considered sufficient under applicable laws. Some applicable laws provide for strict penalties for illegal monitoring or recording of telephone conversations.

RELATED FEATURES LIST

Feature Number	Feature Name
L-5	Live Monitoring
Q-1	Quick Transfer to Voice Mail
S-14	Station Hunting











GUIDE TO FEATURE PROGRAMMING

Digital Voice Mail (Installation)

Order and Shortcut	System Data Name	Memory Block	Function	1-8-07 Attendant Page-Line Key	1-8-08 Station Page-Line Key
 +BS	Card Interface Slot Assignment	7-1			
 +BS	* Telephone Type Assignment	7-2			
 +BS	* Station Number Assignment	4-10			
 +BTT	* Intercom Master Hunt Number Selection	4-14			
 +BTT	* Intercom Master Hunt Number Forward Selection	4-15			
 +AV	* Voice Mail Quick Transfer Master Hunt Number	1-8-26			
 +BA	Intercom Feature Access Code Assignment	1-2-24	007		
 +BTS	Class of Service (Station) Feature Selection 2	1-8-08			1-1, 2-5, 4-5, 4-6
 +BTT	Station to Class of Service Feature Assignment	4-17			
 +BA	Access Code (1-, 2-, 3-Digit) Assignment	1-1-46/47/48	020 ~ 025, 030, 032, 033, 034, 140~143, 027		
 +BCM	Hookflash Time Selection	1-1-02			
 +BCT	DIT Assignment	3-42			
 +BCT	ANA Assignment	3-43			
 +AV	Live Record Trunk Selection	3-45			
 +AV	Live Record Auto Delete Selection	4-46			
 +BTM	Line Key Selection for Telephone Mode	4-12			
 +BTD	Attendant Add-On Console Key Selection	1-6-05			

* When the system is at default this Memory Block **must** be programmed for the feature to be used.

Digital Voice Mail (Caller ID Display with Call Return)

Order and Shortcut	System Data Name	Memory Block	Function	1-8-07 Attendant Page-Line Key	1-8-08 Station Page-Line Key
 +BCT	Trunk-to-Trunk Group Assignment	3-03			
 +BCT	Trunk Type Selection	3-91			
 +BTT	LCR Class Selection	4-40			
 +BTT	* Station to Class of Service Feature Assignment	4-17			
 +AT	Tandem Transfer Automatic Disconnect Time Selection	1-4-00			
 +AB	* ACR Allow/Deny Selection	1-14-01			
 +AB	* ACR Dialling Assignment	1-14-02			
 +AB	* ACR Route Table Number Assignment	1-14-03			
 +AB	* ACR Trunk Group to Route Number Assignment	1-14-04			
 +AB	* ACR Digit Delete Assignment	1-14-05			
 +AB	* ACR Digit Add Assignment	1-14-06			

* When the system is at default this Memory Block **must** be programmed for the feature to be used.

THIS PAGE INTENTIONALLY LEFT BLANK

Direct Inward Dialling (DID)

D-8

FEATURE DESCRIPTION

Direct Inward Dialling lines can be connected to the system. With DID, incoming calls from the CO can reach any station in the system without Attendant intervention.

SYSTEM AVAILABILITY

Terminal Type
All terminals.

Required Components

DID(4)-U() ETU
PRT(1)-U() ETU (With Direct Indial subscribed)
BRT(4)-U() ETU (With Direct Indial subscribed)
VRS(4)-U() ETU (If Automated Attendant required)

OPERATING PROCEDURES

Not applicable.

SERVICE CONDITIONS

Data Assignment

- ⓘ Incoming DID numbers can be routed to any station or tenants (main software release 2 and above) in the system regardless of the numbering plan. If an incoming DID number is invalid, the call can be sent to a preassigned station or hunt group pilot number.
- ⓘ Two different DID digit modification choices are available:
 1. A maximum of two digits can be added and/or deleted from the incoming DID digits provided by the DID trunk for incoming address signalling. This is selectable by System Programming per Trunk Group. [Memory Block 5-00 (Digit Add/Del for Tie Line Networking Assignment.)]
 2. DID Full Digit Modification collects the incoming digits and sends the call to a specified station number.
- ⓘ If a DID incoming call is not answered before a time specified in Memory Block 1-1-07 (Tie Line Delay Ringing Time Selection), the call can switch to normal Day or Night ringing assignment (default: No Timeout).
- ⓘ Allows DIDs to be routed to specified tenants using Memory Block 1-1-22 (DID Digit Conversion Table).
- ⓘ Use Memory Block 1-1-55 (DID Line ringing Pattern Selection) to

change the ringing pattern (default: A) for an incoming DID call.

- ④ Use Memory Block 2-09 (DID Limit to Tenant Assignment) to specify the number of calls allowed to ring at a specified Tenant.
- ④ Use Memory Block 3-14 (Tie Line Type Assignment) to assign loop supervision for each trunk associated with a tie line to 2nd DIAL (default), IMMEDIATE, DELAY or WINK.
- ④ Use Memory Block 7-1 (Card Interface Slot Assignment) to specify the DID(4)-U() ETU.
- ④ Memory Block 1-4-21 cannot be the same as the physical extension, CAR, ACD/UCD/SCD pilot number.

Restrictions

- ④ When DID Full Digit Modification is used the uniform numbering networking cannot be used for incoming DID calls.
- ④ DID calls may be directed to the Automated Attendant. Refer to the Automated Attendant feature.
- ④ A DID calls may be directed to the Automated Attendant. Refer to the Automated Attendant feature.
- ④ When an incoming DID call changes to normal ringing, the call is still counted toward the number of effective calls to the Tenant.
- ④ If the number of DID incoming calls is over the limit, and DID Forward Station Number for Undefined Digit is active, forwarding is not activated and the outside party receives a Burst Tone.

General

- ④ If the number of DID incoming calls is not over the limit, and DID Forward Station Number for Busy Station or Undefined Digit is active, forwarding is activated.
- ④ A maximum of 16 DID(4)-U() ETUs can be installed in the Xen IPK Expanded system. A maximum of 4 DID(4)-U() ETUs can be installed in the Xen IPK Basic system. Each DID(4)-U() ETU provides connection circuitry to handle up to four DID lines. The Xen IPK Expanded system total of 64 trunks and the Xen IPK Basic system total of 16 trunks must be adhered to.
- ④ Each port of the DID(4)-U() ETU can be programmed to receive DTMF or Dial Pulse (10 pps or 20 pps) signalling.
- ④ Any of the following methods of loop supervision can be used for DID lines. This is selectable by System Programming per trunk:
 - Immediate Start
 - Wink Start
 - Delay Start
 - Second Dial Tone

- ④ Incoming calls on Direct Inward Dialling lines follow Call Forward and Station Hunting.
- ④ Direct Inward Dialling calls can be routed to an ACD or UCD Hunt group.
- ④ A DID call does not activate External Tone Ringer or Night Chime.
- ④ Incoming DID calls can be assigned for voice announcement from the outside party system-wide.
- ④ DNIS allows for display of name and number of the DID member, and Calling Line Identification (CLI) of the caller. Refer to Feature D9 (Direct Inward System Access (DISA)).
- ④ A PRI connection can be configured for CO as well as DID calls, on the one service.
- ④ Outgoing restriction can be assigned to DID lines, per station to prevent access when the line is assigned to a line key.
- ④ The number of calls (trunks) used at the same time can be limited.
- ④ Trunk limitation on tenant only applies to incoming calls to the tenant.
- ④ Outgoing calls, individual incoming calls and normal calls are not counted for DID tenant limitation.
- ④ DID calls that change from DID to normal incoming are counted as part of the trunk to tenant limitations.
- ④ Once the DID limit is reached for a tenant, the caller will receive a busy tone.
- ④ If the DID of one group is Call Forwarded to another, or these calls are 'undefined' digits the trunk limitation will not count for these calls.
If the forwarded trunk group's limit has been reached, then the busy tone is given to the originator.
- ④ When a call is terminated to a tenant, termination indication and ringing is performed only on telephones in that tenant. On the telephones in other tenants, the red CO line key LED is on and ringing is not assigned.
- ④ Termination to a tenant can also be specified as the destination for the Busy Station or Undefined Digits.
- ④ DID incoming call termination can also be performed to the destination in the DID Conversion table (Day or Night) according to the day and night modes for that specified tenant.
- ④ When the number of DID incoming calls is over, a busy signal is sent to the network. The reason for refusing an incoming ISDN call is User Busy (Cause #17).

- ④ The following DID Calls are counted against the number of total calls:
 - A call that is placed on hold, transferred or conferenced.
 - A call received by one Tenant and Transferred to another Tenant counts against the first Tenant.
 - A call that is received and disconnected.

Direct Inward Dialling Operation

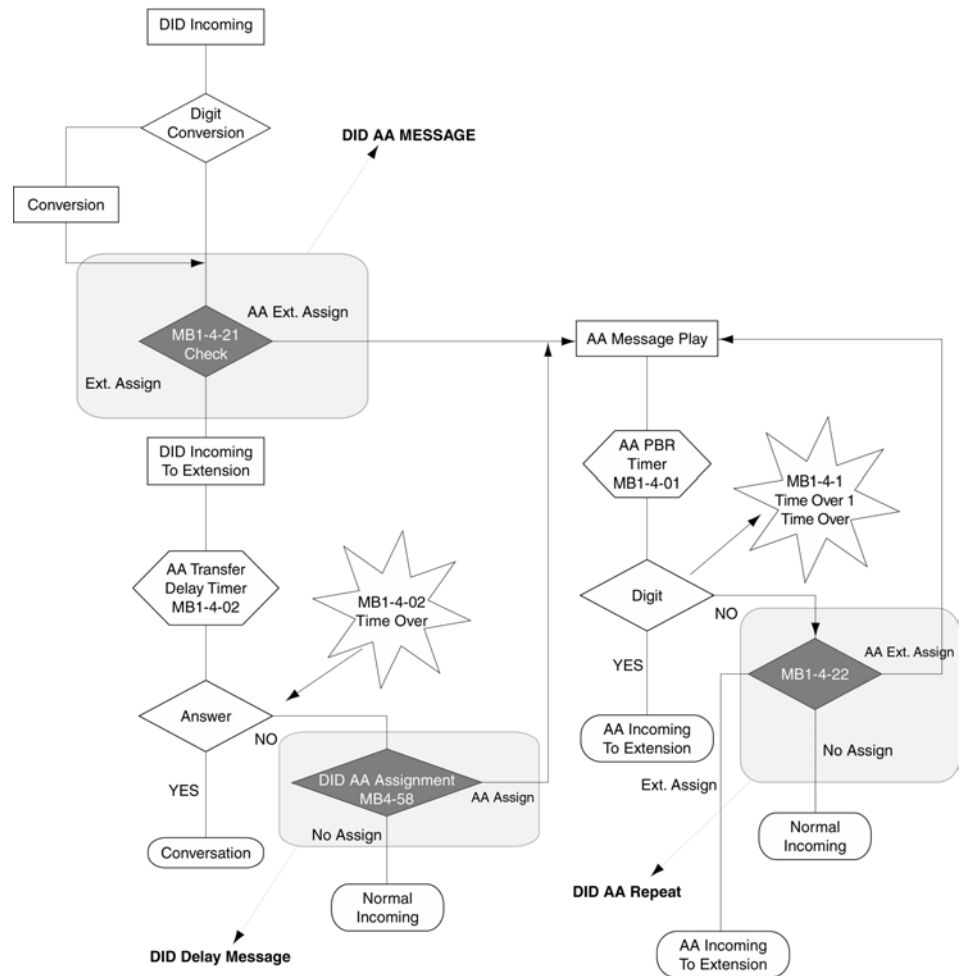



































Figure A8-1: Direct Inward Dialling Operation

GUIDE TO FEATURE PROGRAMMING

Order and Shortcut	System Data Name	Memory Block	Function	1-8-07 Attendant Page-Line Key	1-8-08 Station Page-Line Key
 +BS	Card Interface Slot Assignment	7-1			
 +BCT	* Trunk-to-Trunk Group Assignment	3-03			
 +BCT	* Trunk Type Selection	3-91			
 +ALT	Tie Line Type Assignment	3-14			
 +ALN	Tie Line First Ring Pattern Selection	1-1-34			
 +ALN	Tie Line Delay Ring Pattern Selection	1-1-53			
 +ALN	DID Line Ringing Pattern Selection	1-1-55			
 +ALM	Tie Line Prepause Time Selection	3-16			
 +ALM	Tie Line Wink/Delay Signal Detect Timeout Selection	3-25			
 +ALM	Tie Line Answer Detect Time Selection	3-17			
 +ALM	Tie Line Delay Ringing Time Selection	1-1-07			
 +ALM	Tie Line Release Detect Time Selection	3-18			
 +ALM	Tie Line Length of Wink Signal Selection	3-21			
 +ALM	Tie Line Length of Delay Signal Selection	3-22			
 +ALT	Tie Line Send Tone Selection	3-27			
 +ALT	Tie Line Reorder Tone Selection	3-28			
 +ALN	Digit Add/Del for Tie Line Networking Assignment	5-00			
 +ALN	DID Digit Length Selection	1-1-20			
 +ALN	DID Forward Station Number for Busy or Undefined Digit	1-1-23			
 +ALN	DID Digit Conversion Assignment	1-1-21			

Order and Shortcut	System Data Name	Memory Block	Function	1-8-07 Attendant Page-Line Key	1-8-08 Station Page-Line Key
 +ALN	DID Digit Conversion Table	1-1-22			
 +BTS	Class of Service (Station) Feature Selection 2	1-8-08			4-3, 4-4 5-7
 +BTT	Station to Class of Service Feature Assignment	4-17			
 +BN	DID Limit to Tenant Assignment	2-09			
 +BN	Trunk to Tenant Assignment	2-01			
 +BN	Line Key Selection	2-05			
 +BN	Line Key Selection for Tenant Mode	2-06			
 +BTM	Line Key Selection for Telephone Mode	4-12			
 +BTT	Telephone to Tenant Assignment	4-09			
 +BTT	CO/PBX Ring Assignment (Day Mode)	4-01			
 +BTT	CO/PBX Ring Assignment (Night Mode)	4-02			
 +BTM	Extension Line Key Ring Assignment (Day Mode)	4-37			
 +BTM	Extension Line Key Ring Assignment (Night Mode)	4-38			

* When the system is at default this Memory Block **must** be programmed for the feature to be used.

Direct Inward System Access (DISA)

D-9

FEATURE DESCRIPTION

Direct Inward System Access allows an outside caller to access the system from an outside line without Attendant or station assistance. The outside user may originate calls over any or all of the system facilities such as a Tie line network or CO/PBX trunk after successfully entering a password.

SYSTEM AVAILABILITY

Terminal Type

Not applicable.

Required Components

VRS(4)-U() ETU to hear a message telling the caller which digits to enter for DISA access. A message is not required for DISA to work.

OPERATING PROCEDURES

To place a call using DISA:

1. Dial the desired number to connect to the system.
2. A special tone is heard after ringback tone. (If a VRS(4)-U() ETU is programmed for DISA, a voice announcement can be provided instead of a special tone.)
3. Dial the DISA Access Code.
 - If accepted, internal dial tone is heard.
 - If denied, error tone is heard.
4. Dial the DISA ID code (Station Number).
5. Dial the password.
6. Dial a Trunk Access Code and the desired outside number.

To place an internal call using DISA:

1. Dial the desired number to connect the system.
2. Dial the station number.

To change a DISA password:

1. Go off-hook.
2. Dial the DISA password set Access Code _____ (default not assigned).
3. Enter the ID code (station number is default).
4. Enter the DISA password (default: 0 0 0 0 0 0 0 0 0 0).
5. Enter the new DISA password (maximum: 10 digits).
6. Go on-hook.

To reset the DISA password from the Attendant Position:

1. Go off-hook.
2. Dial the DISA password reset Access Code _____ (default not assigned).
3. Enter the ID code (station number is default). Password is reset.
4. Go on-hook.

To confirm a DISA password from the Attendant Position:

1. Go off-hook.
2. Dial the DISA password confirmation Access Code _____ (default not assigned).
3. Enter the ID code. Current password is displayed.
4. Go on-hook.

To set/cancel a CO/PBX line used for DISA from the Attendant Position:

1. Press **Feature**.
2. Dial 8 7 to set or 8 2 to cancel.
3. Enter the CO/PBX line number (0 0 6 4).
0 0 = All Trunks
4. Press **Feature**.

SERVICE CONDITIONS





Data Assignment





- Ⓢ A DISA Access Code is entered using System Programming.

General

- Ⓢ DTMF signalling is required from the outside caller.
- Ⓢ When the DISA feature is activated, incoming outside callers hear a special tone when DISA trunks are called. These trunks can still be used for outgoing calls.
- Ⓢ A maximum 64 trunks for DISA can be installed in the Xen IPK Expanded system or 16 trunks in the Xen IPK Basic system. Each trunk can be programmed for Day Mode or Night Mode.
- Ⓢ A DISA Password can be programmed from any station. A maximum of 10 digits is allowed.
- Ⓢ The DISA ID Code can be a maximum of four digits, and each can correspond to a station number.
- Ⓢ Code Restriction depends on setting a station that has a DISA ID number.
- Ⓢ DISA ID numbers can be assigned to Allow or Deny in System Programming.
- Ⓢ Outgoing calls via DISA cannot access LCR.
- Ⓢ DISA ID Codes are printed in the SMDR record.
- Ⓢ DISA Password is not printed in SMDR record.
- Ⓢ DISA feature is not available on DID. During DISA access and before entry of a DISA ID Code is completed, press the * key to return the caller to the beginning of the call. The caller is then required to begin dialling the DISA Access Code.
- Ⓢ With a VRS(4)-U() ETU installed, the incoming DISA caller can hear a message telling the caller which digits to enter for DISA access.
- Ⓢ Internal calls must be made before the DISA Access Code is entered.
- Ⓢ The DISA feature allows outgoing trunk calls and internal call including Voice Mail access (if equipped). Call Forwarding and VRS(4)-U() ETU access are not allowed.

GUIDE TO FEATURE PROGRAMMING

Order and Shortcut	System Data Name	Memory Block	Function	1-8-07 Attendant Page-Line Key	1-8-08 Station Page-Line Key
 +BA	Access Codes (1-, 2-, 3-Digit) Assignment	1-1-46/47/48	251~ 253,		
 +AU	* Automated Attendant Message Day/Night Mode Selection	1-4-11			
 +BTI	* SLT or Automated Attendant/DISA to PBR Selection	1-8-01			
 +BCT	* Trunk Incoming Answer Mode Selection	3-05			
 +BTS	Class of Service (Attendant) Feature Selection 1	1-8-07		1-8, 2-5, 2-6	
 +BTS	Class of Service (Station) Feature Selection 2	1-8-08			2-8
 +BTT	Station to Class of Service Feature Assignment	4-17			
 +BD	DISA ID Code Assignment	1-9-00			
 +BD	DISA Password Effect/Invalid Selection	1-9-02			
 +BD	DISA ID Number Station Assignment	4-26			
 +AU	* Automated Attendant Message Access Code (1-Digit) Assignment	1-4-14			
 +AU	Automated Attendant Message Access Code (2-Digit) Assignment	1-4-15			
 +BTS	Specified Station Access Code Assignment	1-2-08			
 +AU	Automated Attendant PBR Start Time Selection	1-4-09			
 +AU	Automated Attendant First Digit PBR Release Time Selection	1-4-01			
 +AU	Automated Attendant PBR Timeout Response Selection	1-4-08			
 +AU	PBR Receive Level Assignment for Automated Attendant/DISA	1-8-02			
 +AU	Automated Attendant Transfer Delayed Ringing Time Selection	1-4-02			
 +AU	Automated Attendant Transfer Ring Pattern	1-1-54			

Order and Shortcut	System Data Name	Memory Block	Function	1-8-07 Attendant Page-Line Key	1-8-08 Station Page-Line Key
 +AU	Automated Attendant No Answer Disconnect Time Selection	1-4-03			
 +BTT	CO/PBX Ring Assignment (Day Mode)	4-01			
 +BTT	CO/PBX Ring Assignment (Night Mode)	4-02			
 +BI	Tone Assignment	1-8-15 (Tone Table)			
 +AT	Tandem Transfer SMDR Print Extension Assignment	1-4-04			

* When the system is at default this Memory Block **must** be programmed for the feature to be used.

THIS PAGE INTENTIONALLY LEFT BLANK

Direct Inward Termination (DIT)

D-10

FEATURE DESCRIPTION

Direct Inward Termination (DIT) allows CO/PBX lines to be programmed to ring directly at stations (bypassing the Attendant). A separate Assigned Night Answer (ANA) ringing assignment is available. A System or Tenant group can be set to the Night Mode independently.

SYSTEM AVAILABILITY

Terminal Type
All terminals.

Required Components
None.

OPERATING PROCEDURES

No manual operation is required.

SERVICE CONDITIONS

Data Assignment

- CO/PBX lines can be assigned to ring a station number, a hunt group master number, or an ACD/UCD Pilot number.
- Multiple CO/PBX lines can be assigned to ring at the same station, hunt group master number, or ACD/UCD Pilot number.
- Separate Day/Night Mode DIT assignments can be programmed in the system. The ANA feature provides the Night Mode DIT assignment.
- Incoming DIT calls follow the station Call Forward setting.

Restrictions

- Incoming DIT calls cannot be answered directly at the CO line key appearance. The CO line key indicates Other Use (red LED).
- A DIT call does not activate External Tone Ringer or Night Chime.

General













- When an idle station programmed for DIT receives an incoming DIT call, internal ring tone is heard at the station(s) where a Secondary Incoming Extension is assigned to ring.
- DIT incoming ringing is assigned for Distinctive Ring or Synchronous Ring system-wide.

- ④ When a busy station programmed for DIT receives an incoming DIT call, the system provides Camp-On tone for the busy station. The calling party receives ringback tone until the call is answered.
- ④ When a busy station receives an incoming DIT Camp-On tone, the existing call can be terminated [held (including Call Park), automatically held, or transferred] to enable the station user to answer the incoming DIT call.
- ④ The ringing can be delayed from 0 to 30 seconds

RELATED FEATURES LIST

Feature Number	Feature Name
A-8	Answer Hold
C-1	Call Alert Notification

GUIDE TO FEATURE PROGRAMMING

Order and Shortcut	System Data Name	Memory Block	Function	1-8-07 Attendant Page-Line Key	1-8-08 Station Page-Line Key
 +BCT	* DIT Assignment	3-42			
 +BCT	* ANA Assignment	3-43			
 +BCT	DIT/ANA Delay Answer Time Selection	3-61			
 +BCT	DIT Tenant Assignment	3-62			
 +BCT	DIT Weekend Mode Selection	3-63			
 +BCT	DIT Night Mode Delay Answer Selection	3-64			
 +BN	Trunk to Tenant Assignment	2-01			
 +BN	Line Key Selection for Tenant Mode	2-06			
 +BTT	Telephone to Tenant Assignment	4-09			
 +BTM	* Line Key Selection for Telephone Mode	4-12			
 +BTT	Call Forward - Busy Immediately/Delay Selection	4-42			
 +BM	Call Forward - No Answer Time Selection	1-2-22			

* When the system is at default this Memory Block **must** be programmed for the feature to be used.

Direct Paging Access

D-11

FEATURE DESCRIPTION

The Attendant Add-On Console Direct Station Selection/Busy Lamp Field (DSS/BLF) keys allow direct access to each of the Internal, External, and All Call Paging. The programmable Feature Access and One-Touch keys on the Multiline Terminals can also be used for Direct Paging Access.

SYSTEM AVAILABILITY

Terminal Type

All Multiline Terminals and Attendant Add-On Consoles .

Required Components

ECR-U() ETU for External Zone Paging.

OPERATING PROCEDURES

To use this feature from a Multiline Terminal with a Feature Access or a One-Touch key programmed for Direct Paging Access or with the Attendant Add-On Console assigned:

1. Go off-hook.
2. Press the Direct Paging Access key.
3. Make the paging announcement.

SERVICE CONDITIONS

Data Assignment

- ⓘ All Attendant Add-On Consoles have eight Direct Paging Access keys. All are set in default as shown:

		DSS Key			DSS Key
1.	Internal Zone A	50	5.	External Zone A	56
2.	Internal Zone B	51	6.	External Zone B	57
3.	Internal Zone C	52	7.	External Zone C	58
4.	All Internal Zone	53	8.	All External Zone	59

- ⓘ Internal Zones A, B, and C are not active until zone assignments are made.

Restrictions

- ⓘ All Internal/External Page Access cannot be programmed to a key on the Attendant Add-On Console.



General

- ⓘ If a Direct Paging Access key for All Internal Zone or Internal Zone Page on the Attendant Add-On Console is pressed, a paging announcement is made over the speakers of all idle Multiline Terminals programmed in a zone.
- ⓘ Paging access through external speakers is available if a system has external speakers. An optional ECR-U() ETU is required for External Zone Paging.
- ⓘ Single Line Telephone users can access Internal and External Paging and Meet-Me by using an Access Code, but cannot receive a paging announcement.
- ⓘ Feature Access and One-Touch keys on Multiline Terminals can be assigned for any type paging allowed in System Programming. This includes the paging features listed previously and All Internal Call Paging, Internal/External Paging, and specific Tenant Internal Paging.

RELATED FEATURES LIST

Feature Number	Feature Name
A-8	Answer Hold
E-6	External Zone Paging (Meet-Me)
I-6	Internal Zone Paging (Meet Me)

GUIDE TO FEATURE PROGRAMMING

Order and Shortcut	System Data Name	Memory Block	Function	1-8-07 Attendant Page-Line Key	1-8-08 Station Page-Line Key
 +BA	Access Code (1-, 2-, or 3-Digit) Assignment	1-1-46/47/48	070 ~079, 081		
 +BTM	Line Key Selection for Telephone Mode	4-12			
 +BTD	Attendant Add-On Console Key Selection	1-6-05			

Direct Station Selection

D-12

FEATURE DESCRIPTION

The Direct Station Selection (DSS) feature allows all Multiline Terminal users to make station calls by pressing only one key.

SYSTEM AVAILABILITY

Terminal Type

All Multiline Terminals and Attendant Add-On Consoles.

Required Components

None.

OPERATING PROCEDURES

To use this feature from a Multiline Terminal with a Feature Access or a One-Touch key programmed for DSS:

1. Press the programmed Feature Access key. Hear ringback tone or make voice announcement.
2. When the called party answers, talk with called party.

To use this feature from a Multiline Terminal with the Attendant Add-On assigned:

1. Lift the headset and receive internal dial tone.
2. Press the DSS/BLF key on the Attendant Add-On Console. Hear ringback tone or make voice announcement.
3. When called party answers, talk with party.

SERVICE CONDITIONS







General

- ④ When station numbers are assigned to Feature Access or One-Touch keys on a Multiline Terminal, the user can press the DSS key to call the station.
- ④ When a station is called by pressing a DSS key and that station is busy, a call waiting tone is sent to the calling station. Any other station that calls the original busy station receives a busy tone while the first calling station is receiving call waiting tone.
- ④ A station user may press a different DSS key on the station or Attendant Add-On Console to directly call another station.
- ④ If a station user, with a completed internal call, calls another station user by pressing a key on the Attendant Add-On Console, the first internal call is placed on hold (Conf key).
- ④ With an outside call in progress, press any DSS key to place the outside call on Non-Exclusive Hold.
- ④ If the DSS key has an LED associated with it, BLF indication is also provided.

RELATED FEATURES LIST

Feature Number	Feature Name
F-1	Feature Access – User Programmable

GUIDE TO FEATURE PROGRAMMING

Order and Shortcut	System Data Name	Memory Block	Function	1-8-07 Attendant Page-Line Key	1-8-08 Station Page-Line Key
 +BS	Telephone Type Assignment	7-2			
 +BTM	Line Key Selection for Telephone Mode	4-12			
 +BTD	Attendant Add-On Console to Telephone Port Assignment	1-6-01			
 +BTD	Attendant Add-On Console Key Selection	1-6-05			
 +BTD	DSS Call Voice/Tone Signal Selection	1-6-03			
 +BN	Line Key Selection	2-05			
 +BN	Line Key Selection for Tenant Mode	2-06			

Distinctive Ringing

D-13

FEATURE DESCRIPTION

The Distinctive Ringing feature distinguishes between internal and incoming outside calls. This feature provides distinct ring audible signals and patterns.

Distinctive Ring can be assigned on a per trunk or per telephone basis.

SYSTEM AVAILABILITY

Terminal Type

All terminals, except Single Line Telephones connected to an AP(R)-R() Unit.

Required Components

None.

OPERATING PROCEDURES

Not applicable.

SERVICE CONDITIONS

Data Assignment

- ④ Synchronous Ringing (Allow or Deny) is assigned system-wide.
- ④ An unanswered CO/PBX call can switch to a different ring tone (higher pitch), if assigned in System Programming. The switching times are 10, 20 and 30 seconds or No Timeout (default: No Timeout).
- ④ An unanswered Tie/DID call can switch to a different ringing pattern and ring selected stations by using the Day or Night Mode Ringing Assignment, if assigned in System Programming. The switching options are 10, 20 and 30 seconds, or No Timeout (default: No Timeout).
- ④ CO distinctive ringing tones can be assigned for each Multiline Terminal or each CO/PBX line system-wide. Then each Multiline Terminal or CO/PBX can be assigned a low, medium, or high tone. The same high tone is used when CO/PBX ring alarm is assigned.
- ④ Transfer ringing cycles and tones are assigned one time for the entire system. This tone and cycle are used for the transferred calls, regardless of the tone and cycle initially used by the trunk.
- ④ The order of Priority of Ring pattern is:
 1. MB 4-59 CO Line Ringing Pattern by Telephone or CO Line Selection
 2. MB 1-1-59 Synchronous Ringing Selection

General



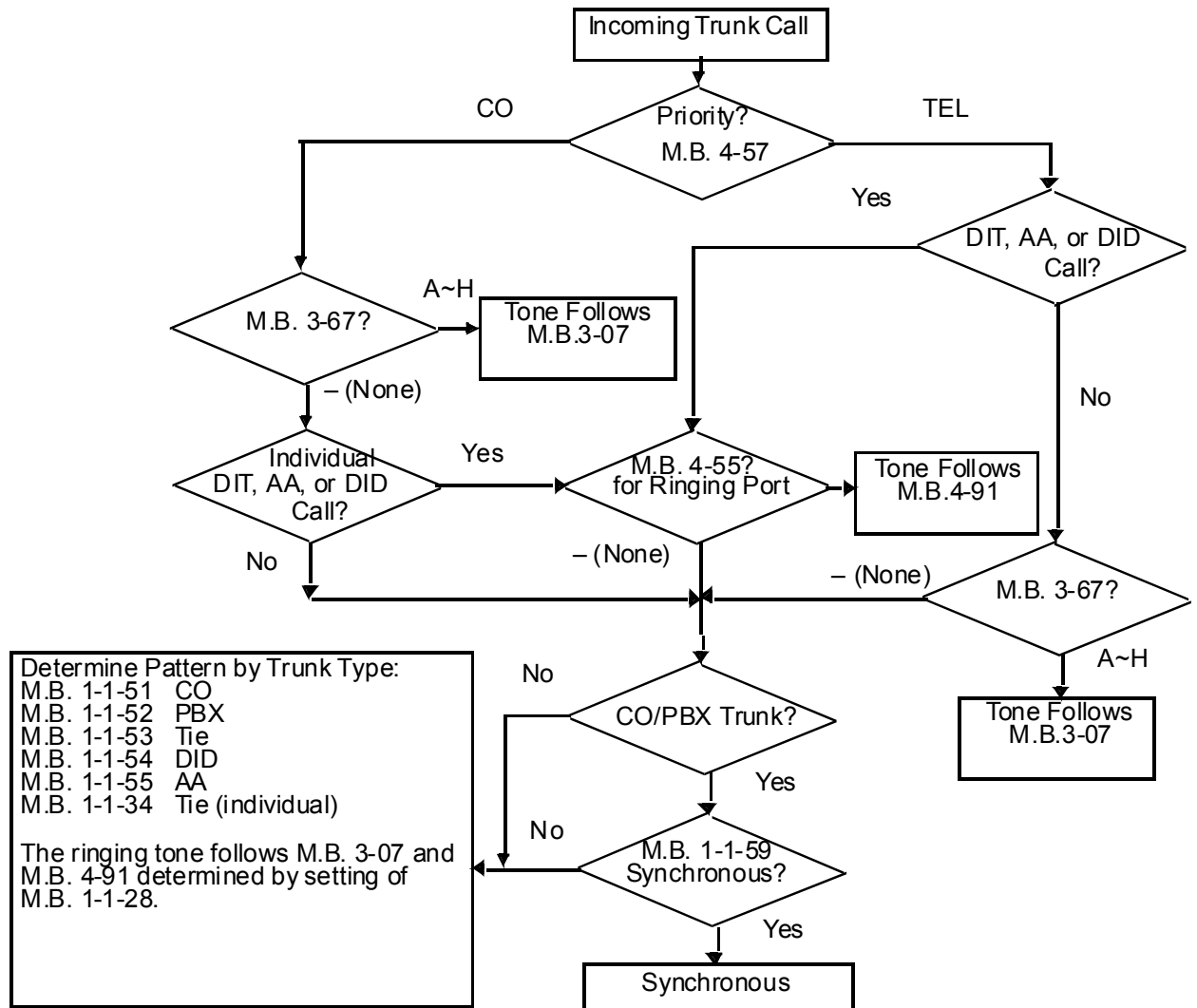







- ④ Incoming outside calls and internal calls provide flexible ringing tones and patterns.
- ④ Distinctive ringing patterns are as follows:
 1. Internal ring tone provides a distinctive ringing pattern of 1 second ON/2 seconds OFF (system default).
 2. Incoming CO/PBX outside calls are assigned synchronous ring. The ringing pattern sent from the exchange connected to the CO PBX/Centrex lines is repeated at all stations assigned to ring, except for Single Line Telephones connected to AP(R)-R()A Units.
 3. If synchronous ringing is disabled, an incoming CO call can be assigned to ring at one pattern and an incoming PBX/Centrex call can ring at a different pattern.
 4. Incoming TIE/DID outside calls provide a distinctive ring pattern of 2 seconds ON/4 seconds OFF (at system default).
 5. Incoming TIE/DID delayed ringing pattern is 0.25 sec. ON/0.25 sec. OFF (at system default).
 6. Automated Attendant transferred calls provide a distinctive ring pattern of 0.5 sec. ON/0.5 sec. OFF (system default).
- ④ DIT/ANA calls to stations also provide Distinctive Ringing (Synchronous ring pattern).
- ④ Internal ringing tone to Multiline Terminals is programmable in System Programming system-wide.



GUIDE TO FEATURE PROGRAMMING

Order and Shortcut	System Data Name	Memory Block	Function	1-8-07 Attendant Page-Line Key	1-8-08 Station Page-Line Key
☎+BTT	* CO Line Ringing Pattern Priority Selection	4-57			
☎+BTT	* CO Line Ringing Pattern Selection for Telephone Mode	4-55			
☎+BCT	* CO Line Ringing Pattern Selection for CO/PBX Line Mode	3-67			
☎+BCS	Synchronous Ringing Selection	1-1-59			

Doc. No. 8201 - Release 1.0
July 2003

Order and Shortcut	System Data Name	Memory Block	Function	1-8-07 Attendant Page-Line Key	1-8-08 Station Page-Line Key
 +BTS	* Distinctive Ringing by Telephone or CO Selection	1-1-28			
 +BCT	CO/PBX Ringing Variation Selection	3-07			
 +BTM	Telephone Ringing Variation Selection	4-91			
 +BCS	CO Line Ringing Pattern Selection	1-1-51			
 +BCS	PBX Line Ringing Pattern Selection	1-1-52			
 +ALN	Tie Line Delay Ring Pattern Selection	1-1-53			
 +BM	CO/PBX Incoming Ringing Alarm Time Selection	1-1-06			
 +ALM	Tie Line Delay Ringing Time Selection	1-1-07			
 +BCS	CO Transfer Ring Pattern Selection	1-1-13			
 +BCS	CO Transfer Ring Tone Selection	1-1-14			
 +BI	Intercom Ring Tone Selection	1-2-20			

* When the system is at default this Memory Block **must** be programmed for the feature to be used.

Do Not Disturb (DND)

D-14

FEATURE DESCRIPTION

The Do Not Disturb (DND) feature temporarily eliminates all audible signals for incoming calls to the station. This temporarily isolates the station from others in the system.

SYSTEM AVAILABILITY

Terminal Type

All terminals.

Required Components

None.

OPERATING PROCEDURES

To set Do Not Disturb using a Multiline Terminal:

1. Press **Feature** in idle mode.
 2. Dial Access Code **6** **0**.
 3. Press **Feature**.
- OR -
4. Press the DND On/Off key.





To set Do Not Disturb for any station:

1. Lift the handset or press **Speaker**.
2. Dial DND set: **4** **0** (set at default).
3. Go on-hook or press **Speaker**.

To cancel Do Not Disturb using a Multiline Terminal

1. Press **Feature** in idle mode.
 2. Dial Access Code **6** **9**.
 3. Press **Feature**.
- OR -
4. Press the DND On/Off key.

To cancel Do Not Disturb from any station



1. Lift the handset or press .
2. Dial DND cancel;   (set at default).
3. Go on-hook or press .

To cancel Call Forward - All Calls and Do No Disturb System-Wide from Attendant Positions only



1. Press .
2. Dial Access Code  .
3. Press .

SERVICE CONDITIONS







Data Assignment

-  At default, the system-wide cancel DND from Attendant Positions is not allowed.
-  DND is allowed or denied in Class of Service.

Restrictions

-  Automatic Callback cannot be set to a station that is in DND mode.
-  If DND and Call Forward - All Calls are set at the same time at a station, Call Forward - All Calls takes priority.

General



-  The Do Not Disturb set and cancel Access Codes can be programmed on separate Feature Access or One-Touch keys. The DND set key LED (if equipped) does not light when DND is set.
-  If a station has a Do Not Disturb single On/Off key assigned, the LED lights when DND is set.
-  When a station user sets this feature, the associated red LED winks on any DSS/BLF key assigned for that station.
-  Transferred/Hold Recalls, Trunk Queues, Automatic Callback, and Barge-In override the DND setting.
-  Setting DND eliminates audible signals that are sent through the speaker, including Voice Announcement. However, a call to this station can still be answered.
-  Callback Request may be set to a Multiline Terminal in DND mode.
-  Ring Transfer, Camp-On, and Tone Override cannot be set to a station that has DND set.

- ④ When DND is set, a Customised Message is displayed in the LCD (if equipped) of the Multiline Terminal. The user can select any of the 10 messages assigned in System Programming.
- ④ Internal calls to a station in DND result in a Call Waiting Tone. The LCD on the calling party Multiline Terminal displays a Customised Message indicating the called party is unavailable.

RELATED FEATURES LIST

Feature Number	Feature Name
C-25	Customised Message

GUIDE TO FEATURE PROGRAMMING

Order and Shortcut	System Data Name	Memory Block	Function	1-8-07 Attendant Page-Line Key	1-8-08 Station Page-Line Key
 +BTS	Class of Service (Attendant) Feature Selection 1	1-8-07		2-3	
 +BTS	Class of Service (Station) Feature Selection 2	1-8-08			1-1
 +BTT	Station to Class of Service Feature Assignment	4-17			

THIS PAGE INTENTIONALLY LEFT BLANK

Door Lock Release Relays

D-15

FEATURE DESCRIPTION

Door Lock Release Relays are provided by the DPH(4)-U() ETU. While a station user is talking to a Doorphone, an Access Code can be dialed to operate the relay associated with that Doorphone. Each Doorphone has a relay associated with it and the relay can only be operated while talking to the Doorphone.

The door lock release relay break time can be controlled by the station user per call.

SYSTEM AVAILABILITY

Terminal Type

All Multiline Terminals.

Required Components

DPH(4)-U() ETU

DP-D-1D Unit

OPERATING PROCEDURES

While a Multiline Terminal is talking to a Doorphone :

1. Dial a single digit code $\textcircled{2}_{ABC}$ ~ $\textcircled{9}_{WXYZ}$ to control the door-to-lock release *make* time.

Note: *Make* means shorted or closed.

2. Dial a single digit code $\textcircled{1}$ or $\textcircled{*}$ to make the relay *break* open again. This step is optional as the relay *breaks* after some time anyway (controlled in step 1).

SERVICE CONDITIONS

- Ⓒ Door Lock Release Relays cannot be controlled by Single Line Telephones.

- Ⓒ Relay *make* times are flexible.







Dial	Time	Dial	Time
2	2 Seconds	7	12 seconds
3	4 seconds	8	14 seconds
4	6 seconds	9	15 seconds
5	8 seconds	1	Break (open)
6	10 seconds	*	Break (open)

- ⓘ The relay is controlled by the last entry. For example, 5 was dialed (8 seconds) then 9 is dialed. One can expect the relay to remain active for 15 more seconds.

RELATED FEATURES LIST

Feature Number	Feature Name
D-16	Door/Monitor Telephone

GUIDE TO FEATURE PROGRAMMING

Order and Shortcut	System Data Name	Memory Block	Function	1-8-07 Attendant Page-Line Key	1-8-08 Station Page-Line Key
 +BN	Card Interface Slot Assignment	7-1			
 +BTP	Doorphone Assignment	1-7-00			
 +BTP	Doorphone Display Time Selection	1-7-01			
 +BTP	Doorphone Ring Pattern Selection	1-7-04			
 +BTP	Doorphone Ringing Frequency Selection	1-7-05			
 +BTP	Doorphone Chime Assignment (Day Mode)	4-03			
 +BCP	Doorphone Chime Assignment (Night Mode)	4-04			

Door/Monitor Telephone

D-16

FEATURE DESCRIPTION

The Xen IPK system supports up to four Door/Monitor telephones. A Doorphone can be called by a station or a station (or number of stations) can be signalled when a Doorphone call button is pressed. When a station answers the Doorphone ringing, a two-way speech path is established.

In addition to the Doorphone ringing assignment, both the tone and cadence of Doorphone ringing can be defined. This offers an easy way for the station user to distinguish a Doorphone call from any other type of call.

The Door/Monitor Telephone works closely with the Door Lock Release feature, and the DPH(4)-U() ETU that supports both features.

SYSTEM AVAILABILITY

Terminal Type

All Multiline Terminals.

Required Components

DPH(4)-U() ETU

DP-D-ID Unit

OPERATING PROCEDURES

To call a Doorphone from a Multiline Terminal:

1. Lift the handset or press .
2. Dial the desired Doorphone Access Code (default is not defined).
3. Door Lock Release can be controlled while talking with the Doorphone.

To answer a Doorphone from a Multiline Terminal:

While the Multiline Terminal requiring Doorphone is ringing, lift the handset or press .

To answer a Doorphone that is ringing at another Multiline Terminal:

1. While the Doorphone Ringing is ringing at some other station, dial the DP1, DP2, DP3, or DP4 Access Code depending on which Doorphone is ringing.
2. The Door Lock Release Relay can be controlled while talking with the

Doorphone user.

SERVICE CONDITIONS

Restrictions

- Doorphone Ringing cannot be assigned to Single Line Telephones. This includes Single Line Telephones supported by analogue port adapters.







General

- Two speech paths are available for Doorphones. Doorphones 1 and 3 share a speech path and Doorphones 2 and 4 share a speech path. When one Doorphone is busy the speech path is also busy. Doorphone Ringing indication works normally, but the second Doorphone cannot be answered until the speech path is idle.

RELATED FEATURES LIST

Feature Number	Feature Name
D-15	Door Lock Release Relays

GUIDE TO FEATURE PROGRAMMING

Order and Shortcut	System Data Name	Memory Block	Function	1-8-07 Attendant Page-Line Key	1-8-08 Station Page-Line Key
 +BS	Card Interface Slot Assignment	7-1			
 +BTP	* Doorphone Assignment	1-7-00			
 +BTP	* Doorphone Chime Assignment (Day Mode)	4-03			
 +BTP	* Doorphone Chime Assignment (Night Mode)	4-04			
 +BTP	Doorphone Ring Pattern Selection	1-7-04			
 +BTP	Doorphone Ringing Frequency Selection	1-7-05			
 +BTP	Doorphone Display Assignment	1-7-01			

* When the system is at default this Memory Block **must** be programmed for the feature to be used.

DP to DTMF Switching

D-17

FEATURE DESCRIPTION

This feature is used for systems connected to Dial Pulse (DP) trunks that require communication with computers that demand DTMF signalling.

SYSTEM AVAILABILITY

Terminal Type

All Multiline Terminals.

Required Components

TLI(2)-U() ETU, COI()-U() ETU, COID()-U() ETU

OPERATING PROCEDURES

To switch an outside call in progress on the Dial Pulse line:

1. Dial * and #.
2. Dial desired number.

SERVICE CONDITIONS

Restrictions

- ☎ Dial Pulse Single Line Telephones cannot send DTMF signals and cannot use this feature.



General

- ☎ After a DP line is switched to DTMF (by using an Access Code), the connection can only be switched back to DP by going on-hook.
- ☎ DP/DTMF switching operations can be programmed as part of the Speed Dial program.
- ☎ This feature is not required for DTMF Single Line Telephones. These telephones send their own DTMF signals over the voice path to the outside equipment.
- ☎ Code Restriction, Outgoing Restriction, and LCR are not bypassed when this feature is used.

**RELATED
FEATURES LIST**

Feature Number	Feature Name
E-3	E&M Tie Lines (4-Wire)
S-6	Single Line Telephone Access

**GUIDE TO
FEATURE
PROGRAMMING**

Order and Shortcut	System Data Name	Memory Block	Function	1-8-07 Attendant Page-Line Key	1-8-08 Station Page-Line Key
 +BS	Card Interface Slot Assignment	7-1			
 +BCT	Trunk (Installed, DP/DTMF) Selection	3-92			

THIS PAGE INTENTIONALLY LEFT BLANK

Drop Key

D-18

FEATURE DESCRIPTION

The Drop Key abandons a call while retaining the PBX/Centrex line for originating another call. The Drop Key is provided by programming a Feature Access or One-Touch key. This feature allows the Recall key to be used to provide a hookflash to the PBX or Central office.

SYSTEM AVAILABILITY

Terminal Type

All Multiline Terminals.

Required Components

None.

OPERATING PROCEDURES

To program a Feature Access key as a Drop key:

1. Press **Feature**.
2. Press **Redial**.
3. Press the Feature Access key.
4. Dial **#**.
5. Dial **5** HL.
6. Press **Feature**.

To program a One-Touch key as a Drop key:

1. Press **Feature**.
2. Press **Redial**.
3. Press the One-Touch key.
4. Dial **#**.
5. Dial **5** HL.
6. Press **Feature**.

To use the Drop key from a Multiline Terminal with a CO/PBX call in progress:

1. Press the Feature Access or One-Touch key programmed as a Drop key.
2. Receive new CO/PBX dial tone.
3. Dial the desired number.

SERVICE CONDITIONS

Restrictions

- ④ The Drop key provides a timed disconnect signal on CO/PBX lines. The time of a disconnect signal is fixed at 1.5 seconds, and cannot be changed by System Programming.
- ④ The Drop key cannot be used for internal, DID, or Tie line calls.



General

- ④ When on a CO/PBX call, you can press the Feature key and dial 5 to use the Drop key function.

RELATED FEATURES LIST

Feature Number	Feature Name
R-1	Recall Key

GUIDE TO FEATURE PROGRAMMING

Order and Shortcut	System Data Name	Memory Block	Function	1-8-07 Attendant Page-Line Key	1-8-08 Station Page-Line Key
 +BN	Line Key Selection	2-05			
 +BN	Line Key Selection for Tenant Mode	2-06			
 +BTM	Line Key Selection for Telephone Mode	4-12			

Dterm Series i Multiline Terminals

D-19

FEATURE DESCRIPTION

The D^{term} Series i Multiline Terminals provide ergonomic form and user-friendly functions. With advanced digital circuitry, these terminals consist of distinct models to meet users' diverse telephone terminal needs.

SYSTEM AVAILABILITY

Terminal Type

DTR-16LD-1A (BK)/(WH) TEL
DTR-32D-1A (BK)/(WH) TEL
DTR-16D-1A (BK)/(WH) TEL
DTR-8D-1A (BK)/(WH) TEL
DTR-2DT-1A (BK) TEL
DCR-60-1A (BK)/(WH) CONSOLE

Required Components

ESI(8)-U() ETU
ESIB(8)-U() ETU
ESIE(8)-U() UNIT

Optional Components

AD(A)-R() UNIT (Adapter for Call Recording)
AP(A)-R() UNIT (Analogue Port Adapter [without Ringer])
AP(R)-R() UNIT (Analogue Port Adapter [with Ringer])
CT(A)-R() UNIT (TAPI Adapter connect by RS-232C)
CT(U)-R() UNIT (TAPI Adapter connect by USB)

WM-R() UNIT (Wall Mount Unit)
ACA-U() UNIT (AC Adapter)

OPERATING PROCEDURES

Refer to individual feature for details.

Specifications

	DTR-16LD-1A	DTR-32D-1A	DTR-16D-1A	DTR-8D-1A	DTR-2DT-1A
Dedicated Function Keys	11	11	11	11	9
Line/Feature Access/ Programmable Feature Access Key	16	32*	16	8	2
LCD (3x24)	Yes	Yes	Yes	Yes	No
Call/Message Indicator	Yes	Yes	Yes	Yes	Yes
Adjustable Base	Yes	Yes	Yes	Yes	No
Built-in Wall Mount	Yes	Yes	Yes	Yes	Yes
Headset Jack (Built-in)	Yes	Yes	Yes	Yes	No
DESI Label by LCD	Yes	No	No	No	No
Receiver Volume Control for:					
Handset	Yes	Yes	Yes	Yes	Yes
Speakerphone	Yes	Yes	Yes	Yes	Yes
Headset	Yes	Yes	Yes	Yes	No
Ring Volume Control	Yes	Yes	Yes	Yes	Yes
LCD Contrast Control	Yes	Yes	Yes	Yes	No
Housing Colour	White or Black	White or Black	White or Black	White or Black	Black
Soft Keys	Yes	Yes	Yes	Yes	No

* A maximum of 24 keys may be programmed as Line Keys.

SERVICE CONDITIONS

General

- ④ The D^{term} Series i Multiline Terminals with an adjustable display offer soft key operation. The LCD panel has three lines of display, each with 24 characters. Standard features include headset jacks, wall mount units, and adjustable-base units.
- ④ The D^{term} Series i Multiline Terminals support dedicated function keys to provide easy one-touch access to the most common telephone operations. These keys include: Feature, Recall, Conference, Redial, Hold, Transfer, Answer, Speaker, Microphone, Directory, and Message. Directory and Message keys are not available on the DTR-2DT-1A (BK) TEL.

- ④ The dial pad is detachable allowing for easy customisation for a foreign language or for Automatic Call Distribution (ACD) applications.
- ④ With the DTR-16LD-1A() TEL, the 16-Line Keys are labelled by the LCD by assignment in system data. The LCD also supports the LED status for trunks, Call Appearance Keys (CAP), DSS/BLF keys, and select Feature keys/Feature Access keys.
- ④ Use Memory Block 4-68 (Line Key Name Assignment) to assign names to each LCD Line Key of the DTR-16LD-1A() TEL Telephone. Up to eight characters can be assigned.
- ④ The LCD of the D^{term} Series i Multiline Terminals provide a volume bar indication, while adjusting the following volume levels or controls:
 - Speaker Volume
 - Handset/Headset Volume
 - BGM Volume
 - Ring Volume/Off Hook Ring Volume
 - LCD Contrast
- ④ The MIC Key controls the built-in microphone during speakerphone mode and controls the handset mute feature during handset/headset operation.
- ④ The Directory Key performs the same function as the Caller ID Scroll Key.
- ④ The Message Key acts as a Voicemail access key to call the Voicemail pilot number.

Restrictions

- ④ For compatibility of Adapter Units and Terminals, refer to the following table:

Adapter Unit	Terminal				
	DTR-16LD-1A	DTR-32D-1A	DTR-16D-1A	DTR-8D-1A	DTR-2DT-1A
AD(A)-R()	X	X	X	X	–
AP(A)-R()	X	X	X	X	–
AP(R)-R()	X	X	X	X	–
CT(A)-R()	X	X	X	X	–
CT(U)-R()	X	X	X	X	–
Button Units					
BS()-R() UNIT	X	X	X	X	–
Other					
WM-R() UNIT	X	X	X	X	–
ACA-U() UNIT	X	X	X	X	–
X = Compatible – = Non-compatible					

- ④ Up to two adapters can be installed in a D^{term} Series i Multiline Terminal (except DTR-2DT-1A). For compatibility of multiple adapter units, refer to the following table.

	AD(A)-R()	AP(A)-R()	AP(R)-R()	CT(A)-R()	CT(U)-R()
AD(A)-R()		X	X	X	X
AP(A)-R()	X		-	X	X *1
AP(R)-R()	X	-		X	X *1
CT(A)-R()	X	X	X		-
CT(U)-R()	X	X *1	X *1	-	

X = Compatible

- = Non-compatible





*1 = The Voice Application of CT(U)-R() cannot be used when installed with AP(A/R)-R() UNIT.

- ④ The ACA-U() UNIT (AC Adapter) is required when any of the following adapters are installed in a D^{term} Series i Multiline Terminal:
- AP(R)-R()
 - CT(U)-R()
 - DCR-60-1A() Console
- ④ The WM-R() UNIT (Wall Mount Unit) is required when any adapter is installed in a D^{term} Series i Multiline Terminal and the terminal is to be wall mounted.

RELATED FEATURES LIST

Feature Number	Feature Name
A-7	Ancillary Device Connection
D-20	DTU-type Multiline Terminal Migration
E-2	Electronic Volume Control
F-6	Full Duplex Handsfree
F-7	Full Handsfree Operation
H-3	Handsfree Dialling and Monitoring
O-1	Off-Hook Ringing
S-9	Softkeys

GUIDE TO FEATURE PROGRAMMING

Order and Shortcut	System Data Name	Memory Block	Function	1-8-07 Attendant Page-Line Key	1-8-08 Station Page-Line Key
 +BS	Telephone Type Assignment	7-2			
 +BTM	Line Key Selection for Telephone Mode	4-12			
 +BTM	Multiline Terminal Type Selection	4-50			
 +BTM	LCD Line Key Name Assignment	4-68			

THIS PAGE INTENTIONALLY LEFT BLANK

DTU-type Multiline Terminal Migration

D-20

FEATURE DESCRIPTION

DTU-type Multiline Terminal Migration allows an Xen Axis/Master customer to protect their investment in terminals when purchasing Xen IPK system. DTU-type Multiline Terminals can be easily used with the Xen IPK systems. With very few exceptions, all terminal features and abilities that are possible on Xen Axis/Master systems are also possible with the Xen IPK system.

SYSTEM AVAILABILITY

Terminal Type

DTU-type Multiline Terminals

Required Components

ESI(8)-U() ETU
ESIB(8)-U() ETU
ESIE(8)-U() UNIT

OPERATING PROCEDURES

Refer to individual feature for details.

SERVICE CONDITIONS

Restrictions



- ⓘ Dedicated Function Keys for Microphone, Directory, and Message are not provided with DTU-type Multiline Terminals.
- ⓘ The Full Duplex handsfree feature is only supported by the DTU-type Multiline Terminals with an HFU-U() Unit installed.
- ⓘ ETW-type Multiline Terminals are not supported with the Xen IPK system.

RELATED FEATURES LIST

Feature Number	Feature Name
A-7	Ancillary Device Connection
D-19	Dterm Series i Multiline Terminals
E-2	Electronic Volume Control
F-6	Full Duplex Handsfree
F-7	Full Handsfree Operation
H-3	Handsfree Dialling and Monitoring
O-1	Off-Hook Ringing

Feature Number	Feature Name
S-9	Softkeys

GUIDE TO FEATURE PROGRAMMING

Order and Shortcut	System Data Name	Memory Block	Function	1-8-07 Attendant Page-Line Key	1-8-08 Station Page-Line Key
 +BS	Telephone Type Assignment	7-2			
 +BTM	Line Key Selection for Telephone Mode	4-12			
 +BTM	Multiline Terminal Type Selection	4-50			

Elapsed Call Timer

E-1

FEATURE DESCRIPTION

The Elapsed Call Timer feature provides each Multiline Terminal with an indication on the LCD showing how long the station has been connected to an outside line.

SYSTEM AVAILABILITY

Terminal Type

All Multiline Terminals equipped with an LCD.

Required Components

None.

OPERATING PROCEDURES

Not applicable.

SERVICE CONDITIONS

General

- ④ The elapsed call time is shown on the LCD when a Multiline Terminal user is talking on an outside line.
- ④ The maximum display on the Elapsed Call Timer is 99 minutes and 59 seconds. When the timer reaches the maximum, it resets to 00 minutes and 00 seconds.
- ④ When a call is placed on hold (Exclusive or Non-Exclusive) or a Transfer Recall, the Elapsed Call Timer continues timing.
- ④ When a transferred call is answered, the Elapsed Call Timer is reset to 00:00.
- ④ For outgoing CO/PBX calls, the starting time is set at 20 seconds (default) after the last digit is dialed. For incoming outside calls, the starting time is immediate. However, there is a five second delay after the call is answered.
- ④ The starting time for outgoing Tie line calls is when the called party answers the call.
- ④ The Elapsed Call Timer display clears during dialling and returns five seconds after the last digit is dialed.
- ④ The Elapsed Call Timer for each outside line operates independently. When several outside calls have been made from a station, the LCD displays the elapsed time when talking on each individual call.
- ④ During a 2-line conference call, the LCD displays the elapsed time of the last individual line call.

- ④ The Elapsed Call Timer display clears when receiving a Tone Override.
- ④ During a conference call that includes one outside party and two internal parties, the Elapsed Call Timer shows on the display of the two internal parties.

GUIDE TO FEATURE PROGRAMMING

Order and Shortcut	System Data Name	Memory Block	Function	1-8-07 Attendant Page-Line Key	1-8-08 Station Page-Line Key
 +BM	Start Time Selection	1-1-05			

Electronic Volume Control

E-2

FEATURE DESCRIPTION

Electronic Volume Control is provided on all Multiline Terminals. This allows for easy changes to the LCD contrast on Multiline Display Terminals, Off-Hook Ringing volume, Station Ringing volume, and Handset/Station Speaker volume control.

SYSTEM AVAILABILITY

Terminal Type







All Multiline Terminals.

Required Components



None.

OPERATING PROCEDURES





To change the LCD contrast for Multiline Terminals with an LCD:

1. Go off-hook by pressing .
2. Dial Access Code   (default).
3. Dial  from the dial pad.
4. Press  (Λ = darker) or  (V = lighter) to increase/decrease LCD contrast.
5. Go on-hook.





- OR -

While the station is idle, press  (Λ = darker) or  (V = lighter) to increase/decrease LCD contrast.

To change the off-hook ringing volume:

1. Go off-hook with the handset.
2. Dial Access Code   (default).
3. Dial  from the dial pad.
4. Press  (Λ = higher) or  (V = lower) to increase/decrease off-hook ringing volume.
5. Go on-hook.



To change the station ringing volume:

1. Go off-hook by pressing .
2. Dial Access Code   (default).
3. Dial  from the dial pad.
4. Press  (\wedge = higher) or (\vee = lower) during ringing to increase/decrease ringing volume.
5. Go on-hook.

To set the handset receiver volume:

1. Go off-hook with the handset.
2. Press  (\wedge = higher) or (\vee = lower) to increase/decrease handset receiver volume.

To set the speaker volume:



1. Go off-hook by pressing .
2. Press  (\wedge = higher) or (\vee = lower) to increase/decrease speaker volume.
3. Go on-hook.

- OR -

While using the speakerphone, press  (\wedge = higher) or (\vee = lower) key to adjust the volume.

SERVICE CONDITIONS



Data Assignment

-  Depending on System Programming, it is possible to retain the last handset receiver volume set by the station user, per station.
-  Single Line Telephone users can also have their handset volume increased by 6 dB in System Programming.

General

-  LCD contrast, off-hook ringing volume, station ringing volume, and speaker volume adjustments are saved in system memory.

GUIDE TO FEATURE PROGRAMMING

Order and Shortcut	System Data Name	Memory Block	Function	1-8-07 Attendant Page-Line Key	1-8-08 Station Page-Line Key
 +BTT	* Access Code (1-, 2-, or 3-Digit) Assignment	1-1-46/47/48	049		
 +BTT	Receiving Volume Selection	4-92			

THIS PAGE INTENTIONALLY LEFT BLANK

E&M Tie Lines (4-Wire)

E-3

FEATURE DESCRIPTION

E&M Tie Lines (4-Wire) can be connected to the system. Tie lines provide access to and from remote systems and facilities. The system can receive and/or transmit DTMF or Dial Pulse signals on E&M Tie Lines.

SYSTEM AVAILABILITY

Terminal Type

All terminals

Required Components

TLI(2)-U() ETUs

OPERATING PROCEDURES

To originate a call:

1. Dial the Trunk Group Access Code assigned for E&M Tie Lines.
 2. Dial the station to be called, or if using Uniform Numbering Network, dial the distant system number and the station to be called, or dial the Trunk Access Code and number to be called.
- OR -
3. Press the line key with direct E&M Tie Line appearance, and receive a dial tone.
 4. Dial the station to be called if using Uniform Numbering Network, dial the distant system number and the station to be called, or dial the Trunk Access Code and number to be called.

SERVICE CONDITIONS

Data Assignment

- ④ Each port of the TLI(2)-U() ETU can be programmed to send and receive DTMF or Dial Pulse signalling (10 or 20 pps) on E&M Tie Lines.
- ④ Dial tone can be sent or disabled on E&M Tie Lines to distant systems via System Programming (default: Send Dial Tone).
- ④ Access to E&M Tie Lines can be denied, per line/per station, via Outgoing Restriction.
- ④ Each station in the system can be restricted to a maximum number of digits that can be dialled out on a Tie line when Code Restriction is programmed in System Programming.

- ④ Internal and External Transmit and Receive pad adjustments (volume levels) are programmable in System Programming.
- ④ An unanswered Tie/DID call can be switched to a different ringing pattern and ring selected stations by using the Day or Night Mode ringing assignment, if assigned, in System Programming. The switching options are 10, 20, 30 seconds, or No Timeout (default: No Timeout).
- ④ Tie/DID lines can be assigned to add up to two digits and/or delete up to two digits per Trunk group as needed, in System Programming.





















General









- ④ Each TLI(2)-U() ETU supports a maximum of two 4-wire E&M Tie Lines.
- ④ When a call from/to the remote end is made to a busy station in the Xen IPK systems, the caller cannot set Callback Request, Step Call, or Camp-On.
- ④ The incoming ringing pattern for Tie line calls can be changed in System Programming, or voice announcement can be selected system-wide (default: 2 seconds ON/4 seconds OFF).
- ④ Any of the following methods of loop supervision can be selected via System Programming per trunk: immediate start, wink start, delay start, or second dial tone (default: Second Dial Tone).
- ④ If voice announcement for incoming Tie calls is selected, the outside party cannot switch the call to a ringing call.
- ④ The Recall key and Drop key are ignored when Tie lines are used.

RELATED FEATURES LIST

Feature Number	Feature Name
F-3	Flexible Numbering Plan
T-1	Tandem Switching of 4-Wire E&M Tie Lines
T-6	Trunk-to-Trunk Transfer
U-2	Uniform Numbering Network

GUIDE TO FEATURE PROGRAMMING

Order and Shortcut	System Data Name	Memory Block	Function	1-8-07 Attendant Page-Line Key	1-8-08 Station Page-Line Key
 +BS	Card Interface Slot Assignment	7-1			
 +BCT	Trunk Type Selection	3-91			
 +BCT	Trunk (Installed, DP/DTMF) Selection	3-92			
 +BCT	Trunk-to-Trunk Group Assignment	3-03			
 +ALT	Tie Line Type Assignment	3-14			
 +BCT	Trunk DTMF Duration/Interdigit Selection	3-15			
 +ALM	Tie Line Prepause Time Selection	3-16			
 +ALM	Tie Line Answer Detect Time Selection	3-17			
 +ALM	Tie Line Release Detect Time Selection	3-18			
 +ALM	Tie Line Wink/Delay Signal Detect Timeout Selection	3-25			
 +ALM	Tie Line Loop Off-Guard Time Selection	3-20			
 +ALM	Tie Line Length of Wink Signal Selection	3-21			
 +ALM	Tie Line Length of Delay Signal Selection	3-22			
 +ALM	Tie Line Incoming Interdigit Timeout Selection	3-24			
 +BCT	Tie Line/CO/PBX Incoming Signal Detect Time Selection	3-19			
 +ALN	Digit Add/Del for Tie Line Networking Assignment	5-00			
 +ALN	Tie Line First Ring Pattern Selection	1-1-34			
 +ALM	Tie Line Delay Ringing Time Selection	1-1-07			
 +ALN	Tie Line Delay Ring Pattern Selection	1-1-53			
 +AC	Tie Line Code Restriction Assignment	1-1-69			
 +BCT	Trunk Internal Transmit Pad Selection	3-29			

Order and Shortcut	System Data Name	Memory Block	Function	1-8-07 Attendant Page-Line Key	1-8-08 Station Page-Line Key
 +BCT	Trunk Internal Receive Pad Selection	3-30			
 +BCT	Trunk External Transmit Pad Selection	3-31			
 +BCT	Trunk External Receive Pad Selection	3-32			
 +ALT	Tie Line Dial Tone Selection	3-27			
 +ALT	Tie Line Reorder Tone Selection	3-28			
 +BTT	CO/PBX Ring Assignment (Day Mode)	4-01			
 +BTT	CO/PBX Ring Assignment (Night Mode)	4-02			
 +BTT	Trunk Digit Restriction	4-32			

Equal Access Accommodation

E-4

FEATURE DESCRIPTION

The Equal Access Accommodation feature permits Speed Dial memories and Code Restriction to be applied to CO/PBX lines that provide access to Specialised Common Carriers (SCCs).

SYSTEM AVAILABILITY

Terminal Type

All terminals

Required Components

None

OPERATING PROCEDURES

To use this feature from a Multiline Terminal:

1. Press an outside line key.
2. Dial Equal Access Code $\textcircled{1}$ $\textcircled{0}$ + XXX. Equal Access inspection is applied.
3. Dial the long distance number.
4. Talk with called party.

To use this feature from a Single Line Telephone:

1. Lift the handset, and receive internal dial tone.
2. Dial a trunk Access Code, and receive outside dial tone.
3. Dial Equal Access Code $\textcircled{1}$ $\textcircled{0}$ + XXX.
4. Dial the applicable long distance number. Code Restriction inspection is applied.
5. Talk with called party.







SERVICE CONDITIONS

- \textcircled{C} Stations can have access to other specified long distance common carriers by Code Restriction Class Assignment (Day and Night) when assigned in System Programming.
- \textcircled{C} Code Restriction applies after an Other Common Carrier (OCC) code is dialled.

RELATED FEATURES LIST

Feature Number	Feature Name
C-19	Code Restriction
C-21	CO/PBX, Tie Line Digit Restriction

GUIDE TO FEATURE PROGRAMMING

Order and Shortcut	System Data Name	Memory Block	Function	1-8-07 Attendant Page-Line Key	1-8-08 Station Page-Line Key
 +AC	OCC Table Assignment	1-1-67			
 +AC	OCC Table to Trunk Group Assignment	5-03			
 +AC	8-Digit Matching Table to OCC Table Assignment	1-1-68			
 +AC	* Code Restriction Class Assignment (Day Mode)	4-07			
 +AC	* Code Restriction Class Assignment (Night Mode)	4-08			
 +AC	8-Digit Matching Table to Class Assignment	1-1-61			

* When the system is at default this Memory Block **must** be programmed for the feature to be used.

External Tone Ringer

E-5

FEATURE DESCRIPTION

The External Tone Ringer provides a common audible tone signal with relay contacts for control when incoming CO/PBX calls are received in Day and Night Mode. The relay contact closures may be used for external bells or chimes. When an Attendant is not available, station users may respond to the external ring signal and answer incoming calls. This feature provides for wide area coverage or loud ringing for noisy locations when there are incoming CO/PBX calls to be answered.

SYSTEM AVAILABILITY

Terminal Type

Not applicable.

Required Components

ECR-U() ETU for common audible and control relays

OPERATING PROCEDURES





Not applicable.

SERVICE CONDITIONS

General

- ④ An ECR-U() ETU is required for common audible and control relays. Ten relays are provided with this ETU.
- ④ A maximum of four relays are programmable for External Tone Ringer control.
- ④ Each External Tone Ringer control relay is programmable based on Tenant Groups.
- ④ Each External Tone Ringer control circuit is programmable for one of five distinctive ringing intervals, including continuous ring.
- ④ Tie lines, DIT/ANA calls, and DID trunks do not activate the External Tone Ringer control relays.
- ④ The external ringing equipment must be locally provided.
- ④ Incoming calls to an External Tone Ringer can be answered by Call Pickup (Intra-tenant/Inter-tenant).
- ④ The External Tone Ringer feature does not operate on a trunk that is not assigned to a Tenant group.

GUIDE TO FEATURE PROGRAMMING

Order and Shortcut	System Data Name	Memory Block	Function	1-8-07 Attendant Page-Line Key	1-8-08 Station Page-Line Key
 +BS	Card Interface Slot Assignment	7-1			
 +BP	General Purpose Relay Assignment	1-8-37			
 +BN	* ECR Relay to Tenant Assignment	2-08			
 +BP	External Ring Relay Cycle Selection	1-7-07			

* When the system is at default this Memory Block **must** be programmed for the feature to be used.

External Zone Paging (Meet-Me)

E-6

FEATURE DESCRIPTION

The External Zone Paging (Meet-Me) feature allows for up to three zones of External Zone Paging plus All Zone External Paging. This feature allows the user to locate personnel quickly using external paging. An external speaker can be installed in a noisy area where a telephone would not be appropriate. All Zone External Paging enables emergency announcements to be made to all areas quickly. The Meet-Me function allows the paged party to respond quickly to the paged call.

With the Xen IPK system, a single external paging zone output is built into and provided with the basic B64-U() KSU.

SYSTEM AVAILABILITY

Terminal Type

All terminals.

Required Components

ECR-U() ETU and a 1- or 2-way amplifier

OPERATING PROCEDURES

To originate on a Multiline Terminals:

1. Lift the handset.
2. Dial the Access Code $\textcircled{5}_{JKL} \textcircled{5}_{JKL} \sim \textcircled{5}_{JKL} \textcircled{9}_{WXYZ}$ (as set in default) for the required zone, or press the programmed Feature Access or One-Touch key.

To answer on a Multiline Terminals:

1. Lift the handset.
2. Dial the Meet-Me Access Code ($\textcircled{5}_{JKL} \textcircled{*}$, if the page is an Internal/ External Page, or $\textcircled{5}_{JKL} \textcircled{\#}$, if the page is an External Page, as set in default), or press the programmed Feature Access or One-Touch key.

To originate on a Single Line Telephones:

1. Lift the handset.
2. Dial the desired Access Code $\textcircled{5}_{JKL} \textcircled{5}_{JKL} \sim \textcircled{5}_{JKL} \textcircled{9}_{WXYZ}$ (as set in default) for the required zone.

To answer on a Single Line Telephones:

1. Lift the handset.
2. Dial the Meet-Me Access Code ($\textcircled{5}$ $\textcircled{9}$ $\textcircled{*}$, if the page is an Internal/ External Page, or $\textcircled{5}$ $\textcircled{\#}$, if the page is only an External Page, as set in default).

SERVICE CONDITIONS

Data Assignment

- \textcircled{f} After five minutes (default value for External Page timeout) a page automatically disconnects.
- \textcircled{f} An alert tone to external speakers can be specified in System Programming. The alert tone can be provided at the beginning and end of the external page.
- \textcircled{f} Internal and External Zone Paging time outs can be assigned individually. During an All Internal/External Zone Page, the external timeout timer is used.

General

- \textcircled{f} Up to three zones of paging and All Zone Paging are possible.
- \textcircled{f} When an External Zone Page is in progress (either Zone A, B, C, or All Zone), no other station can activate External Zone Paging until all zones become idle again.
- \textcircled{f} Default Access Codes are:









All External Zones	55	Default Access Codes can be changed at the time of installation.
External Zone A	56	
External Zone B	57	
External Zone C	58	
All Internal/External Zones	59	
External Meet-Me	5#	
Internal Meet-Me	5*	

- \textcircled{f} After a page is established and the Meet-Me code is dialed, the paging circuit is released and another party may page.
- \textcircled{f} If external speakers are used, they must be specified (YES/NO) in System Programming as being connected to the system. Up to three external zones can be connected.
- \textcircled{f} A Multiline Terminal user can conference an outside line with an External Zone Page; this allows a conversation to be monitored by people within speaker range.
- \textcircled{f} Talk Back Paging is supported on Xen IPK.
- \textcircled{f} A single external paging zone is built into the Xen IPK KSU.

RELATED FEATURES LIST

Feature Number	Feature Name
B-2	Background Music Over External Speakers

GUIDE TO FEATURE PROGRAMMING

Order and Shortcut	System Data Name	Memory Block	Function	1-8-07 Attendant Page-Line Key	1-8-08 Station Page-Line Key
 +BS	Card Interface Slot Assignment	7-1			
 +BA	Access Code (1-, 2-, or 3-Digit) Assignment	1-1-46/47/48	074 ~ 079, 081		
 +BTD	Attendant Add-On Console Key Assignment	1-6-05			
 +BP	External Speaker Connection Selection	1-7-02			
 +BP	External Paging Alert Tone Selection	1-7-03			
 +BP	External Paging Timeout Selection	1-7-06			
 +BP	External Speaker Pre-Tone/Chime Selection	1-7-08			
 +BP	External Speaker Chime Start Time Selection	1-7-09			
 +BTM	Line Key Selection for Telephone Mode	4-12			

THIS PAGE INTENTIONALLY LEFT BLANK

Feature Access – User Programmable

F-1

FEATURE DESCRIPTION

The User Programmable - Feature Access keys and One-Touch keys on the Multiline Terminals can be used for System/Station Speed Dial and many system features.

SYSTEM AVAILABILITY

Terminal Type

All Multiline Terminals.

Required Components

None.

OPERATING PROCEDURES

To program the Feature Access key for DSS/BLF:

1. Press **Feature**.
2. Press **Redial**.
3. Press the Feature Access key.
4. Dial **1**.
5. Dial the station number.
6. Dial **1** (optional step, refer to Note).

Note: Dialling 1 switches the call from Voice to Tone or Tone to Voice.

7. Press **Feature**.

To program the Feature Access key for Station Speed Dial:

1. Press **Feature**.
2. Press **Redial**.
3. Press the Feature Access key.
4. Dial **0**.
5. Dial the Trunk or Trunk Group Access Code (maximum 4 digits).
6. Dial the telephone number to be dialled.
7. Press **Feature**.

To program the Feature Access key for a dial code feature:

1. Press **Feature**.
2. Press **Redial**.
3. Press the Feature Access key.
4. Dial **1**.
5. Dial the feature code
6. Press **Feature**.

To program a Feature Access key for a Feature key + code feature:

1. Press **Feature**.
2. Press **Redial**.
3. Press the Feature Access key.
4. Dial **#**. (**#** is used to indicate **Feature** to the Xen IPK system.)
5. Dial the Feature Access Code.
6. Press **Feature**.

SERVICE CONDITIONS

Data Assignment

- ④ Feature Access keys and One-Touch keys are similar in purpose and ability. Up to 16 feature access keys are available depending on system programming. Unused Line keys can be assigned as Feature Access keys. One-Touch key availability is controlled by the type of Multiline Terminal.



General

- ④ Line keys, not used for CO/PBX line access, may be assigned as Feature Access keys in System Programming. The user can then program the Feature Access keys for Speed Dial, DSS/BLF, and selected features (e.g., Call Pickup, Paging, DND set, and DND cancel).
- ④ Each Feature Access key can store up to 16 digits.

RELATED FEATURES LIST

Feature Number	Feature Name
D-12	Direct Station Selection
F-2	Flexible Line Assignment
N-1	Nesting Dial
O-3	One-Touch/Feature Access Key
S-10	Speed Dial – Station
S-12	Speed Dial – System

GUIDE TO FEATURE PROGRAMMING

Order and Shortcut	System Data Name	Memory Block	Function	1-8-07 Attendant Page-Line Key	1-8-08 Station Page-Line Key
 +BN	Line Key Selection	2-05			
 +BN	Line Key Selection for Tenant Mode	2-06			
 +BTM	Line Key Selection for Telephone Mode	4-12			

THIS PAGE INTENTIONALLY LEFT BLANK

Flexible Line Assignment

F-2

FEATURE DESCRIPTION

Each Multiline Terminal has complete flexibility of line key assignments to meet individual needs. Functions can be programmed on Flexible Line Keys, including DSS numbers and a variety of Feature Access Codes to simplify the use of these functions. Outside line appearances and Secondary Incoming Extensions can also be assigned to Flexible Line keys.

SYSTEM AVAILABILITY

Terminal Type

All Multiline Terminals.

Required Components

None.

OPERATING PROCEDURES

Not applicable.

SERVICE CONDITIONS

Data Assignment



- ④ Flexible Line key assignment is done in System Programming.
- ④ Memory Block 4-50 (Multiline Terminal Type Selection) to assign a 32-button terminal with 16 (default) or 24 line keys.

General

- ④ Each Flexible Line key can be assigned one of the following 10 options:
 1. Outside Lines (01~64)
 2. Trunk Groups (01~32)
 3. Route Advance Blocks (01~32)
 4. Secondary Incoming Extensions (01~120)
 5. Call Appearance keys (for Groups 00~47, Locations 01~24)
 6. Feature Access keys (01~16)
Applicable for tenant mode and telephone mode.
 7. MIC ON/OFF key
 8. Headset ON/OFF key
 9. Call Arrival Key (05~120)

10. Scroll Key for Caller ID Indication
 11. Call Forward - Busy/No Answer
 12. Call Forward - All Calls
 13. Do Not Disturb/Break On/Off
 14. Log On/Off
 15. Background Music On/Off
 16. ICM key (only one is possible per hand set)
- ☉ SIE and CAR extensions are used for incoming call pickup operation only. Outgoing calls cannot be made using these features.
 - ☉ The DTR-8D-1A() TEL and DTU-8D-1A() TEL have eight Flexible Line keys.
 - ☉ The DTR-16D-1A() TEL, DTU-16D-1A() TEL, DTU-32D-1A() TEL each have 16 flexible line keys.
 - ☉ The DTR-32D-1A() TEL has 16 or 24 flexible line keys.
 - ☉ A maximum of one MIC ON/OFF key and one Headset ON/OFF key can be assigned for each Multiline Terminal.
 - ☉ Feature Access keys are programmed by the user for DSS, Speed Dial, or Feature Access Codes.
 - ☉ At system default, Flexible Line keys 01~08 are assigned as CO 01~08, if 8 trunks are installed. Any unassigned trunks will be indicated as vacant.
 - ☉ There are 16 Feature Access keys per terminal, each is unique and cannot be double assigned in one terminal.

GUIDE TO FEATURE PROGRAMMING

Order and Shortcut	System Data Name	Memory Block	Function	1-8-07 Attendant Page-Line Key	1-8-08 Station Page-Line Key
 +BN	Line Key Selection	2-05			
 +BN	Line Key Selection for Tenant Mode	2-06			
 +BTM	Line Key Selection for Telephone Mode	4-12			

Flexible Numbering Plan

F-3

FEATURE DESCRIPTION

A Flexible Numbering Plan is automatically assigned by the Resident System Program when the system power is first turned on. The Station Numbering Plan may be changed via System Programming to fit customer needs. A station can be assigned a 2-, 3-, or 4-digit station number. An Automated Attendant Numbering Plan is also available within the Flexible Numbering Plan.

SYSTEM AVAILABILITY

Terminal Type

All terminals.

Required Components

None.

OPERATING PROCEDURES

Not applicable.

SERVICE CONDITIONS

Data Assignment

- Station Numbering Plan, Automated Attendant/DISA Numbering Plan, and Uniform Numbering plan can be assigned in System Programming.



Restrictions

- The same station number may not be assigned to two or more stations.
- Station Numbering Plan can be 2, 3, or 4 digits; however, only one plan can be used at a time.

General

- The default station numbers are 100~219 (depending on system configuration).
- Refer to the Xen IPK System Programming Manual for the Numbering Plan Access Code defaults.

GUIDE TO FEATURE PROGRAMMING

Order and Shortcut	System Data Name	Memory Block	Function	1-8-07 Attendant Page-Line Key	1-8-08 Station Page-Line Key
 +BS	2-, 3-, or 4-Digit Station Numbering Selection	1-2-03			
 +BA	Access Code (1- or 2-Digit) Assignment	1-1-46/47	001		
 +BS	Station Number Assignment	4-10			

Flexible Ringing Assignment

F-4

FEATURE DESCRIPTION

Flexible Ringing Assignments for incoming outside calls and Secondary Incoming Extension appearances can be programmed to ring at specified Multiline Terminals. Separate day and night ring assignments are available and Delayed Ringing is an option for Multiline Terminals.

SYSTEM AVAILABILITY

Terminal Type

All terminals.

Required Components

None.

OPERATING PROCEDURES

Not applicable.

SERVICE CONDITIONS















Data Assignment

- ④ CO/PBX ringing is assigned per line, per station. Day and Night mode are also independently assigned.
- ④ Secondary Incoming Extensions and Call Arrival Keys can be assigned to ring at Multiline Terminals, per extension/per line key, if assigned on a Flexible Line key. Day and Night mode are also independently assigned.
- ④ Distinctive Ringing Assignments can be programmed in System Programming per station or per trunk.

General

- ④ Single Line Telephones can be assigned to ring for any line.
- ④ Single Line Telephones support Delayed Ringing.
- ④ Default values assign Attendants 1 and 2 (stations 100 and 101) to have CO/PBX lines 01~08 ringing.

GUIDE TO FEATURE PROGRAMMING

Order and Shortcut	System Data Name	Memory Block	Function	1-8-07 Attendant Page-Line Key	1-8-08 Station Page-Line Key
 +BTM	Line Key Selection for Telephone Mode	4-12			
 +BTT	CO/PBX Ring Assignment (Day Mode)	4-01			
 +BTT	CO/PBX Ring Assignment (Night Mode)	4-02			
 +BTT	CO/PBX Answer Key Operation Without Ringing Assignment (Day Mode)	4-52			
 +BTT	CO/PBX Answer Key Operation Without Ringing Assignment (Night Mode)	4-53			
 +BTM	Extension Line Key Ring Assignment (Day Mode)	4-37			
 +BTM	Extension Line Key Ring Assignment (Night Mode)	4-38			
 +BTP	Doorphone Chime Assignment (Day Mode)	4-03			
 +BTP	Doorphone Chime Assignment (Night Mode)	4-04			
 +BTS	Distinctive Ring by Telephone or CO Selection	1-1-28			
 +BCT	CO/PBX Ringing Variation Selection	3-07			
 +BTM	Telephone Ringing Variation Selection	4-91			
 +BI	Intercom Ring Pattern Selection	1-2-19			
 +BI	Intercom Ring Tone Selection	1-2-20			
 +BTM	Off-Hook Ringing Selection	4-51			

* When the system is at default this Memory Block **must** be programmed for the feature to be used.

Flexible Timeouts

F-5

FEATURE DESCRIPTION

The Flexible Timeouts feature provides a variety of timeouts in the Resident System Program to allow the system to operate without initial programming. The system timeouts can be changed to meet customer needs according to the requirements of the system application.

SYSTEM AVAILABILITY

Terminal Type

All terminals.

Required Components

None.







OPERATING PROCEDURES

Not applicable.

SERVICE CONDITIONS

☎ Refer to the Xen IPK System Programming Manual for more information.

GUIDE TO FEATURE PROGRAMMING

Order and Shortcut	System Data Name	Memory Block	Function	1-8-07 Attendant Page-Line Key	1-8-08 Station Page-Line Key
 +AU	Automated Attendant Answer Delay Time Assignment	1-4-13			
 +AU	Automated Attendant First Digit PBR Release Time Selection	1-4-01			
 +AU	Automated Attendant No Answer Disconnect Time Selection	1-4-03			
 +AU	Automated Attendant Transfer Delayed Ringing Time Selection	1-4-02			
 +BCM	CO/PBX Prepause Time Selection	1-1-57			
 +BCM	DP Interdigit Time Selection	1-1-01			
 +BCM	Hookflash Time Selection	1-1-02			

Order and Shortcut	System Data Name	Memory Block	Function	1-8-07 Attendant Page-Line Key	1-8-08 Station Page-Line Key
 +BCM	Pause Time Selection	1-1-00			
 +BCT	Automatic Release Signal Detection Time Selection	3-40			
 +BCT	Disconnect Recognition Time Selection	3-33			
 +BCT	Trunk DTMF Duration/Interdigit Selection	3-15			
 +BCT	Tie Line CO/PBX Incoming Signal Detect Time Selection	3-19			
 +AR	First Delay Announcement Start Time Selection	1-1-71			
 +AR	First to Second Delay Announcement Interval Time Selection	1-1-73			
 +AR	Second Delay Announcement Repeat Interval Time Selection	1-1-75			
 +BP	External Paging Timeout Selection	1-7-06			
 +BM	Automatic Callback Release Time Selection	1-2-02			
 +BM	Call Forward – No Answer Time Selection	1-2-22			
 +BM	CO/PBX Incoming Ringing Alarm Time Selection	1-1-06			
 +BM	PBR Interdigit Release Time Selection	1-8-10			
 +BM	Start Time Selection	1-1-05			
 +BM	System Refresh Time Assignment	1-8-11			
 +BM	Trunk Queuing Timeout Selection	1-1-37			
 +ALM	Tie Line Incoming Interdigit Timeout Selection	3-24			
 +ALM	Tie Line Length of Delay Signal Selection	3-22			
 +ALM	Tie Line Length of Wink Signal Selection	3-21			
 +ALM	Tie Line Loop Off-Guard Time Selection	3-20			
 +BP	Internal Paging Timeout Selection	1-2-00			
 +ALM	Tie Line Answer Detect Time Selection	3-17			
 +ALM	Tie Line Prepause Time Selection	3-16			

Order and Shortcut	System Data Name	Memory Block	Function	1-8-07 Attendant Page-Line Key	1-8-08 Station Page-Line Key
 +ALM	Tie Line Release Detect Time Selection	3-18			
 +ALM	Tie Line Wink/Delay Signal Detect Timeout Selection	3-25			
 +BM	Attendant Add-On Console Transfer/Camp-On Recall Time Selection	1-1-64			
 +BM	Hold Recall Time Selection (Exclusive)	1-1-63			
 +BM	Hold Recall Time Selection (Non-Exclusive Hold)	1-1-03			
 +BM	Station Transfer/Camp-On Recall Time Selection	1-1-12			
 +BM	System Call Park Recall Time Selection	1-2-23			
 +BTI	Bounce Protect Time Selection	1-3-01			
 +BTI	First Digit PBR Release Time Selection	1-3-03			
 +BTI	Hookflash End Time Selection	1-3-06			
 +BTI	Hookflash Start Time Selection	1-3-05			
 +AS	SMDR Valid Call Time Assignment	1-5-25			
 +ALM	Tie Line Delay Ringing Time Selection	1-1-07			
 +AT	Tandem Transfer Automatic Disconnect Time Selection	1-4-00			
 +AV	Voice Mail Disconnect Time Selection	1-3-09			
 +AV	Voice Mail DTMF Delay Time Selection	1-3-08			
 +AV	Voice Mail DTMF Duration/Interdigit Time Selection	1-3-10			

THIS PAGE INTENTIONALLY LEFT BLANK

Full Duplex Handsfree

F-6

FEATURE DESCRIPTION

The HFU-U() Unit is an add-on device to the DTU-Type Multiline Terminals that provides full duplex speakerphone ability. An external microphone is also provided with the HFU-U() Unit. The microphone has a push-to-mute control button that turns the microphone off when it is pushed and held down.

SYSTEM AVAILABILITY

Terminal Type

All DTU-Type Multiline Terminals

Required Components

The HFU-U() Unit must be installed in each DTU-Type Multiline Terminal.

OPERATING PROCEDURES

To use the HFU-U():

1. Press  and make an internal or external call.
2. When muting is desired press and hold down the Mute key on the external microphone.

SERVICE CONDITIONS

General

- ⓘ This is a full duplex unit, however, it cannot be assumed to work as well as a conference-room-type speakerphone. The echo cancellation is geared towards a smaller area (such as an office) with average acoustic realities. Large environment or areas that have hard surfaces that tend to bounce sound have an adverse affect on the speakerphone quality. The HFU-U() Unit can be turned to a half-duplex mode in these cases.

GUIDE TO FEATURE PROGRAMMING

Order and Shortcut	System Data Name	Memory Block	Function	1-8-07 Attendant Page-Line Key	1-8-08 Station Page-Line Key
 +BTM	* HFU Selection	4-29			

* When the system is at default this Memory Block **must** be programmed for the feature to be used.

Full Handsfree Operation

F-7

FEATURE DESCRIPTION

A built-in handsfree ability is included with all Multiline Terminals for internal and outside calls. A MIC ON/OFF key or Feature Access Code allows the microphone to be muted.



SYSTEM AVAILABILITY

Terminal Type
All Multiline Terminals.

Required Components
None.

OPERATING PROCEDURES

To turn the built-in Microphone ON/OFF:

1. Press .
2. Dial .
- OR -
3. Press the Flexible Line key assigned as a MIC ON/OFF key or One-Touch key programmed as a Microphone Control key.

To use this feature with Multiline Terminal :

ORIGINATING

1. Press .
2. Dial the desired internal or outside number.
3. Talk with the party when the call is answered.
- OR -
4. Press the desired Feature Access or One-Touch key programmed for Speed Dial.
5. Talk with the party when the call is answered.

ANSWERING

1. Press the line key receiving an incoming call or press .
2. Talk with the calling party.

SERVICE CONDITIONS

General

- ④ One Override can be received during handsfree conversation.
- ④ The microphone must be ON to answer calls handsfree.
- ④ A Flexible Line key can be assigned as a MIC ON/OFF key, or a One-Touch key can be programmed as a Microphone Control key.
- ④ While engaged on an outside line conversation using the built-in Handsfree Operation feature, the conversation may be interrupted (half-duplex) if both parties speak simultaneously.
- ④ Allow or Deny Full Handsfree Operation is determined, per station, via System Programming.
- ④ During a conversation, the MIC ON/OFF key can be used to mute the microphone.
- ④ Monitoring volume can be adjusted using the volume control on the Multiline Terminal.
- ④ When a Multiline Terminal user lifts the handset, the monitoring condition is automatically released, and the Speaker LED goes off.
- ④ The built-in Speakerphone is a half-duplex speaker phone. Noisy or poor acoustical environments have a large impact on the speaker phone switching from transmit to receive calls and vice versa.

GUIDE TO FEATURE PROGRAMMING

Order and Shortcut	System Data Name	Memory Block	Function	1-8-07 Attendant Page-Line Key	1-8-08 Station Page-Line Key
 +BTM	* HFU Selection	4-29			

* When the system is at default this Memory Block **must** be programmed for the feature to be used.

General Purpose Relays

G-1

FEATURE DESCRIPTION

Two relays located on the ECR-U() ETU are designated for use as an application dictates. These relays are either off or on, and do not change state until a station user manually makes the change.

SYSTEM AVAILABILITY

Terminal Type

All Multiline Terminals.

Attendant Add-on Console.

Required Components

ECR-U() ETU

OPERATING PROCEDURES

To control the General Purpose Relay from the Attendant Add-on Console:

1. Press the key assigned GPR0 or GPR1.
2. The GPR LED is on (red) to indicate the relay is closed (on), or Off to indicate the relay is open (off).

To control the General Purpose Relay from a Multiline Terminal:





To turn the GPR relay on:

1. Press **Feature** + **0**.
2. Dial the relay number **0** or **1** (for GPR0 or GPR1).
3. Dial the desired number + **Feature**.



To turn the GPR relay off:

1. Press **Feature** + **0**.
2. Dial the relay number **0** or **1** (for GPR0 or GPR1).
3. Dial the ***** + **Feature**.





To toggle the relay from on to off (or off to on):

1. Press  + .
2. Dial the relay number  or  (for GPR0 or GPR1).
3. Press .

**SERVICE
CONDITIONS**

-  The rating of the General Purpose relays are 24 Vdc at 500 mA.
-  The red LED indication is provided to indicate on or off when the GPR Access Codes are assigned to a Feature Access key.
-  The LED indication is provided to all Feature Access keys and Attendant Add-on Consoles that are assigned with a GPR0 or GPR1 key.

**GUIDE TO
FEATURE
PROGRAMMING**

Order and Shortcut	System Data Name	Memory Block	Function	1-8-07 Attendant Page-Line Key	1-8-08 Station Page-Line Key
 +BTS	Class of Service (Station) Feature Selection 2	1-8-08			1-7
 +BP	General Purpose Relay Assignment	1-8-37			
 +BN	* ECR Relay to Tenant Assignment	2-08			
 +BP	External Ring Relay Pattern Selection	1-7-07			
 +BTD	Attendant Add-On Console Key Selection	1-6-05			

* When the system is at default this Memory Block **must** be programmed for the feature to be used.

Group Listening

G-2

FEATURE DESCRIPTION

The Group Listening feature allows user to press the Speaker key so others in the room can listen to a conversation over the built-in speaker of a Multiline Terminal. While Group Listening is active, the Multiline Terminal user can continue to talk on the handset or headset.

SYSTEM AVAILABILITY

Terminal Type

All Multiline Terminals.

Required Components

None.

OPERATING PROCEDURES

To activate/deactivate Group Listening:

1. While using the handset/headset, prospect activate Group Listening.
2. Press  or go on-hook to end Group Listening.

To mute the handset during Group Listening using DTU-Type Multiline Terminals :

While Group Listening is active, press the MIC button.



SERVICE CONDITIONS

General

- ⓘ Group Listening applies to the following conditions:
 - During an internal call
 - During an outside call
 - During a conference call
 - During a Voice Over call
 - During a Whisper Page call
- ⓘ The Group Listening feature is assigned in Station Class of Service.
- ⓘ A feedback loop is possible if the Group Listening feature is not cancelled before the handset is placed in the cradle. The outside caller hears a feedback squeal. When switching to Handsfree Monitor Mode or Speakerphone Mode, NEC recommends muting the handset before placing it in the cradle.

- ④ When the user goes on-hook during Group Listening, the call is automatically placed in Handsfree Monitor/Speakerphone Mode and Group Listening is cancelled.
- ④ Off-hook ringing is provided with this feature.
- ④ Camp-on tone and Tone Override are heard over the handset, headset, or speakerphone.
- ④ During Group Listening, speaker volume can be adjusted using the Multiline Terminal volume control. The handset volume cannot be adjusted.
- ④ During Group Listening, the user cannot use the built-in microphone for handsfree use. When the MIC key is pressed, it controls the handset mute and the MIC LED flashes red during handset mute mode.

GUIDE TO FEATURE PROGRAMMING

Order and Shortcut	System Data Name	Memory Block	Function	1-8-07 Attendant Page-Line Key	1-8-08 Station Page-Line Key
 +BTS	* Class of Service (Station) Feature Selection 2	1-8-08			5-2
 +BTT	Station to Class of Service Feature Assignment	4-17			

* When the system is at default this Memory Block **must** be programmed for the feature to be used.

Handset Mute

H-1

FEATURE DESCRIPTION

The Handset Mute feature is provided to most terminals connected to the Xen IPK system. While talking on the Multiline Terminal handset, a station user can dial a feature code or press MIC button to mute the transmit speech path. The station user can still hear the outside (or intercom) voice.



SYSTEM AVAILABILITY

Terminal Type
All Multiline Terminals.

Required Components
None.

OPERATING PROCEDURES

While talking on a Multiline Terminal Handset:

1. Press  + .

SERVICE CONDITIONS

None.

RELATED FEATURES LIST

Feature Number	Feature Name
F-1	Feature Access – User Programmable

GUIDE TO FEATURE PROGRAMMING

Order and Shortcut	System Data Name	Memory Block	Function	1-8-07 Attendant Page-Line Key	1-8-08 Station Page-Line Key
 +BTM	Line Key Selection for Telephone Mode	4-12			

THIS PAGE INTENTIONALLY LEFT BLANK

Handsfree Answerback

H-2

FEATURE DESCRIPTION

Each Multiline Terminal is equipped with a microphone for Handsfree Answerback during internal voice calls. Microphone status is indicated by a MIC LED located on each Multiline Terminal. The MIC key or Feature Access Code is used to mute the microphone to ensure privacy.



SYSTEM AVAILABILITY

Terminal Type
All Multiline Terminals.

Required Components
None.

OPERATING PROCEDURES

To turn microphone ON/OFF:

1. Press .
2. Dial .

- OR -

Press the programmable line key assigned as a MIC ON/OFF key.

- OR -

Press the *Push to Mute* button on the external microphone on the HFU-U() Unit.

To use this feature when receiving an internal voice call:



1. Ensure MIC LED is on.
2. Talk with calling party.

SERVICE CONDITIONS

Data Assignment

-  A programmable line key can be assigned as a MIC ON/OFF key.

Restrictions

-  If a station is signalled by a tone signal, the station user cannot respond with Handsfree Answerback, unless the calling party changes to voice call.
-  This feature works only for incoming internal voice calls.







General

- ④ Multiline Terminal MIC LED must be turned on.
- ④ The calling station controls the voice announcement or ringing signal.
- ④ Multiline Terminal users can receive voice calls from Single Line Telephone users.
- ④ Group Call Pickup and Call Forwarding do not operate for voice announcement calls.

RELATED FEATURES LIST

Feature Number	Feature Name
I-4	Internal Voice/Tone Signalling

GUIDE TO FEATURE PROGRAMMING

Order and Shortcut	System Data Name	Memory Block	Function	1-8-07 Attendant Page-Line Key	1-8-08 Station Page-Line Key
 +BI	Intercom Call Voice/Tone Signal Selection	1-2-01			
 +BTD	DSS Call Voice/Tone Signal Selection	1-6-03			
 +BA	Intercom Feature access Code Assignment	1-2-24	001		
 +BN	Line Key Selection	2-05			
 +BN	Line Key Selection for Tenant Mode	2-06			
 +BTM	Line Key Selection for Telephone Mode	4-12			

Handsfree Dialling and Monitoring

H-3

FEATURE DESCRIPTION

The Handsfree Dialling and Monitoring feature enables all Multiline Terminal users to dial and monitor calls without using the handset. This feature frees the user to perform other tasks while waiting for a call to be answered or while on hold.

SYSTEM AVAILABILITY

Terminal Type

All Multiline Terminals.

Required Components

None.

OPERATING PROCEDURES

To use handsfree dialling:

1. Press .
2. Use any dialling method allowed by the system.
3. When the party answers, talk using the handset or built-in Handsfree Unit if enabled.
4. If a no answer or busy tone is received, prospect disconnect the line.

To use monitoring with a call in progress:



1. Press .
2. Restore the handset.

SERVICE CONDITIONS

Restrictions

-  This feature is available only on Multiline Terminals.

General

-  A Multiline Terminal is considered off-hook by the system when this feature is used.
-  This feature may be used for internal and outside calls.
-  Monitoring volume may be adjusted using the volume control on the Multiline Terminal.

- ④ When a Multiline Terminal user lifts the handset, the monitoring condition is automatically released, and the Speaker LED goes off.
- ④ The Multiline Terminal must remain in monitor mode when Automatic Redial is being used.

RELATED FEATURES LIST

Feature Number	Feature Name
A-24	Automatic Hold

Headset Connection (Built In)

H-4

FEATURE DESCRIPTION

A headset can be connected directly to a D^{term} Series i or DTU-type Multiline Terminal. This eliminates the need for an external headset switch. In addition, a headset ON/OFF key can be assigned to the terminal to allow easy operation of the headset.

SYSTEM AVAILABILITY

Terminal Type

All Multiline Terminals.

Required Components

None.

OPERATING PROCEDURES

To make a call:

1. Press the headset ON/OFF key.
2. Dial the desired number and talk.

To end a call:

1. At the end of a conversation, press the headset ON/OFF key.
2. Call is disconnected.

SERVICE CONDITIONS

General

- ⓘ This feature works with several compatible capsule-only type headsets.



Note: Capsule-only type headsets do not require external power. The Multiline Terminal provides a built-in headset amplifier and volume control.

- ⓘ The headset ON/OFF Feature Access key must be programmed in System Programming.

RELATED FEATURES LIST

Feature Number	Feature Name
F-1	Feature Access – User Programmable

GUIDE TO FEATURE PROGRAMMING

Order and Shortcut	System Data Name	Memory Block	Function	1-8-07 Attendant Page-Line Key	1-8-08 Station Page-Line Key
 +BN	Line Key Selection	2-05			
 +BN	Line Key Selection for Tenant	2-06			
 +BTM	* Line Key Selection for Telephone Mode	4-12			

* When the system is at default this Memory Block **must** be programmed for the feature to be used.

Hold With Recall (Exclusive & Non- Exclusive)

H-5

FEATURE DESCRIPTION

Station users can place a call on Hold, to free the station for other calls. Multiline Terminal users can use Exclusive Hold (a held line can only be picked up at the station that put the line on hold) and Non-Exclusive Hold (a held line can be picked up at any station that has access to that line). Single Line Telephone users place calls on Exclusive Hold. A call on hold for longer than a preprogrammed interval generates a recall at the originating station. When the recalled Multiline Terminal is idle, an audible signal and an LCD indication (if equipped) are provided to indicate that the line is recalling.

SYSTEM AVAILABILITY

Terminal Type
All terminals.

Required Components
None.

OPERATING PROCEDURES

To execute from a Multiline Terminal with an outside call in progress (Non-Exclusive Hold):

1. Press **Hold**.
2. To retrieve a Non-Exclusive Hold call, press the flashing line key or Call Appearance Key.

To execute from a Multiline Terminal with an outside call in progress (Exclusive Hold):

1. Press **Feature** and then **Hold**.
2. To retrieve an Exclusive Hold call, press the flashing line key or Call Appearance Key.

To execute from a Single Line Telephone with a Call in progress:

1. Momentarily press the hookswitch; the call is placed on Exclusive Hold. If the handset is returned to the cradle, the call recalls immediately.
2. To retrieve a held call, momentarily press the hookswitch; the held call is connected.

- OR -

To retrieve a held call, return the handset to the cradle.

3. When recall begins, lift the handset and the call is connected.

SERVICE CONDITIONS

MULTILINE TERMINAL

Non-Exclusive Hold

- ④ After Non-Exclusive Hold is set, the user can originate or answer other calls.
- ④ Any station with the same outside line or programmed Call Appearance key can pick up the held call.
- ④ A CO/PBX call on Non-Exclusive Hold can be picked up by dialling an Access Code (Specified Line Seizure) if assigned in System Programming.
- ④ After a preprogrammed time (default: 1 minute), the held or parked line recalls to the station where the call was placed on Hold.
- ④ The station where the Hold originated receives an I-Hold indication (flashing green LED). The LED associated with the held line key flashes red on all other Multiline Terminals.

Exclusive Hold

- ④ After Exclusive Hold is set, the user can originate or answer other calls.
- ④ If assigned, a call is held on a CO line key appearance. If not assigned, the call is exclusively held on Call Appearance key.
- ④ Only the station where the Exclusive Hold was set can retrieve the held call, until the call recalls.
- ④ After a preprogrammed time (default: 1 minute), the held line recalls to the station where the call was placed on hold and the held call changes to Non-Exclusive Hold.
- ④ The LED of other Multiline Terminals for the held line have a red LED steadily lit until the call recalls.
- ④ Exclusive Hold and Non-Exclusive Hold Recall time intervals can be adjusted independently of one another.



Hold Recall

- ④ Provides a timed reminder to the user that a call was placed on hold.
- ④ When a held line recalls, Multiline Terminals equipped with an LCD receive the following information: the upper LCD line shows the recalling outside line number, the lower LCD line shows the station number the call was held at and the station number where the call was transferred (used for recalling Ring Transfer or Camp-On calls).
- ④ Non-Exclusive Hold, Ring Transfer, Hold Recall, Call Park System, and Attendant Ring Transfer/Camp-On have separate Recall Timers.
- ④ For Multiline Terminals, internally held calls do not recall.
- ④ A Recall Tone is provided when the handset is on-hook. Off-key ringing is not provided if the handset is off-hook.

Single Line Telephone

- ④ If the user goes on-hook during Exclusive Hold, a recall immediately follows.
- ④ When a line is holding on a Multiline Terminal, the red LED is steadily lit until the Exclusive Hold Recall Timer expires.
- ④ The System Call Park feature can be used to put calls on hold.

GUIDE TO FEATURE PROGRAMMING

Order and Shortcut	System Data Name	Memory Block	Function	1-8-07 Attendant Page-Line Key	1-8-08 Station Page-Line Key
 +BM	Hold Recall Time Selection (Non-Exclusive Hold)	1-1-03			
 +BM	Hold Recall Time Selection (Exclusive)	1-1-63			
 +BTM	Hold/Transfer Recall Display Selection	4-30			

THIS PAGE INTENTIONALLY LEFT BLANK

Hot Line

H-6

FEATURE DESCRIPTION

The Hot Line feature enables a station user to automatically dial an outside number or another station when the station goes off-hook. This feature is provided for Multiline Terminals and Single Line Telephones.

SYSTEM AVAILABILITY

Terminal Type
All terminals.

Required Components
None.

OPERATING PROCEDURES

To execute from any station programmed for Hot Line:

1. Go off-hook by lifting the handset or pressing .
2. The station or outside number is called.

SERVICE CONDITIONS

Data Assignment

- ☎ The Hot Line feature must be programmed in System Programming.



General

- ☎ There is no limit, other than hardware abilities, to the number of Hot Lines that can be supported in the system.
- ☎ Up to 10 digits can be stored for dialling, including Trunk Access Codes.
- ☎ Multiline Terminal users assigned Hot Line can press the Feature key and Access Code 6* or press Feature + Speaker to receive internal dial tone.
- ☎ With Hot Line assigned, internal dial tone can be received by pressing the Hold, Conference, or Transfer key.

RELATED FEATURES LIST

Feature Number	Feature Name
F-1	Feature Access – User Programmable

GUIDE TO FEATURE PROGRAMMING

Order and Shortcut	System Data Name	Memory Block	Function	1-8-07 Attendant Page-Line Key	1-8-08 Station Page-Line Key
 +BA	Access Code (1-, 2-, or 3-Digit) Assignment	1-1-46/47/ 48	001 101~ 132, 176~199, 201~232, 401~416		
 +BTT	* Prime Line/Hot Line Assignment	4-23			

* When the system is at default this Memory Block **must** be programmed for the feature to be used.

Howler Tone Service

H-7

FEATURE DESCRIPTION

The Howler Tone Service feature provides a Howler Tone when a station remains off-hook after a call is completed or when a station is off-hook and digits are not dialled in a predetermined time.

SYSTEM AVAILABILITY

Terminal Type
All terminals.

Required Components
None.

OPERATING PROCEDURES

Not applicable.

SERVICE CONDITIONS

- ④ Howler tone occurs 30 seconds after a call has been disconnected or digits have not been dialled.
- ④ The Howler tone is continuously modulating at 2400 Hz and 16 Hz, by system default. This cycle can be changed in System Programming.
- ④ This tone can be disabled (system-wide) in System Programming.

GUIDE TO FEATURE PROGRAMMING

Order and Shortcut	System Data Name	Memory Block	Function	1-8-07 Attendant Page-Line Key	1-8-08 Station Page-Line Key
 +BI	Tone Assignment	1-8-15			

* When the system is at default this Memory Block **must** be programmed for the feature to be used.

THIS PAGE INTENTIONALLY LEFT BLANK

I-Hold Indication

I-1

FEATURE DESCRIPTION

The I-Hold Indication feature provides a green LED line key indication for calls held at a Multiline Terminal. Calls held at other stations provide a red LED line key indication. This feature allows easy identification of calls the user placed on hold.

SYSTEM AVAILABILITY

Terminal Type

All Multiline Terminals.

Required Components

None.

OPERATING PROCEDURES





To place a call on Hold:

1. Press **Hold** (the call is placed on Non-Exclusive Hold).
- OR -
2. Press **Feature**, and then **Hold** (the call is placed on Exclusive Hold).

SERVICE CONDITIONS

- ⓘ The I-Hold and other hold-flash rates are the same, 0.25 seconds ON/ 0.25 seconds OFF.
- ⓘ When a call is placed on Exclusive Hold, all other Multiline Terminals with that line appearance receive a busy indication (steady red LED).
- ⓘ Internal calls can only be put on Exclusive Hold.
- ⓘ Answer Hold, Transfer Hold, and Conference Hold use the I-Hold indication.

GUIDE TO FEATURE PROGRAMMING

Order and Shortcut	System Data Name	Memory Block	Function	1-8-07 Attendant Page-Line Key	1-8-08 Station Page-Line Key
 +BM	Hold Recall Time Selection (Non-Exclusive Hold)	1-1-03			
 +BM	Hold Recall Time Selection (Exclusive)	1-1-63			
 +BM	Station Transfer/Camp-On Recall Time Selection	1-1-12			
 +BM	Attendant Add-On Console Transfer/Camp-On Recall Time Selection	1-1-64			

Incoming Call Identification

I-2

FEATURE DESCRIPTION

The Incoming Call Identification feature identifies incoming calls on Multiline Terminals with an LCD. Internal calls are identified by showing the caller name and station number. A ringing Tie line/DID call generates a display on the LCD of the line number.

SYSTEM AVAILABILITY

Terminal Type

All Multiline Terminals with LCD.

Required Components

None.

OPERATING PROCEDURES



For an incoming internal call

1. The ICM LED flashes.
2. The caller station number and name (if assigned) are displayed on the LCD.

SERVICE CONDITIONS

- ④ When an internal call is received at a station, that station user number is displayed to the left, and the station number and name (if assigned) of the station where the call was initiated are displayed to the right on the LCD. If the call is placed on hold, the station user number remains and the number of the station where the call was initiated disappears.
- ④ In an Add-On Conference, the station numbers of the parties are displayed.
- ④ Each station can be assigned a name (maximum of six characters, including spaces).
- ④ Incoming Call Identification is provided for Internal Ring Transfer, Call Forward, and CO Transfer Ring.

GUIDE TO FEATURE PROGRAMMING

Order and Shortcut	System Data Name	Memory Block	Function	1-8-07 Attendant Page-Line Key	1-8-08 Station Page-Line Key
 +BCT	* Trunk Name/Number Assignment	3-00			
 +BTT	Station Name Assignment	4-18			

* When the system is at default this Memory Block **must** be programmed for the feature to be used.

Intercom By-Pass CO Call

I-3

FEATURE DESCRIPTION

This feature allows a multiline telephone user to bypass a ringing trunk call and make an intercom call instead when the station is assigned with ringing line preference.



SYSTEM AVAILABILITY

Terminal Type
Multiline Terminals.

Required components
None.

OPERATION PROCEDURE

Accessing extension while a CO call is offered.

1. Press ICM Key or dial   to obtain intercom dial tone.
2. Dial extension number.

SERVICE CONDITIONS

Data Assignment

- ④ The ICM key must be assigned to the Multiline Terminal at the time of system programming.

THIS PAGE INTENTIONALLY LEFT BLANK

Internal Voice/Tone Signalling

I-4

FEATURE DESCRIPTION

The Internal Voice/Tone Signalling feature allows Multiline Terminal users to be signalled on incoming internal calls by voice announcement or by ringing, depending on System Programming. The caller can dial an additional digit to switch a voice announcement call to a ringing call, or switch a ringing call to voice announcement. This feature allows Voice/Tone switching from the calling side.

SYSTEM AVAILABILITY

Terminal Type

All Multiline Terminals.

Required Components

None.

OPERATING PROCEDURES

When programmed for Voice/Tone:

1. Lift the handset, and receive internal dial tone.
2. Dial the station number.
3. Receive voice page alert tone.
4. Voice announce the call.
5. Called party can reply handsfree.

- OR -

Dial  (set as default). (Called party lifts the handset to respond to ringing.)

When programmed for Tone/Voice:

1. Lift the handset, and receive internal dial tone.
2. Dial the station number. (Called party station rings.)
3. Talk with party after the call is answered.

- OR -

Dial  (set as default).

4. Voice announce the call.
5. Called party can reply handsfree.

SERVICE CONDITIONS

Data Assignment

- ☎ Voice/Tone or Tone/Voice is assigned in System Programming system-wide (default: voice/tone call).



Restrictions

- ☎ Single Line Telephone users can voice announce to Multiline Terminal users but cannot receive voice announcements.

General

- ☎ The Access Code used to change from a voice call to a tone call, or from a tone call to a voice call, can be changed in System Programming.
- ☎ Voice or Tone can be selected as often as needed by dialling **1** (set as default) during a call.
- ☎ If the station is receiving a handsfree call, the MIC must be activated for reply.
- ☎ Single Line Telephone users can switch from voice to tone or from tone to voice by dialling **1** (set at default) during an internal call to a Multiline Terminal.
- ☎ When a voice announcement is received at a Multiline Terminal, other audible signals cannot be received.
- ☎ This feature allows Voice/Tone switching only from the calling side.

GUIDE TO FEATURE PROGRAMMING

Order and Shortcut	System Data Name	Memory Block	Function	1-8-07 Attendant Page-Line Key	1-8-08 Station Page-Line Key
 +BI	Intercom Call Voice/Tone Signal Selection	1-2-01			
 +BTD	DSS Call Voice/Tone Signal Selection	1-6-03			
 +BA	Intercom Feature Access Code Assignment	1-2-24	001		



Intercom Function

I-5

FEATURE DESCRIPTION

This feature allows all internal extensions to call each other without accessing the telephony network.

There are three ways to generate an intercom call.

1. Using speaker key when Prime Line (refer to P5 of this document) or Hot Line (refer to H6 of this document) is not set.
2. Using a Intercom key programmed into the Multiline Terminal.
3. Pressing  followed by the  key on a Multiline Terminal.

SYSTEM AVAILABILITY

Terminal Type

Multiline Terminals
Single Line Telephone

Require Components

ESI(8)-U() ETU
ESIB(8)-U() ETU
ESIE(8)-U() ETU
SLI(4)-U() ETU
SLI(8)-U() ETU

OPERATING PROCEDURES

On MLT and SLT without Prime Line or Hot Line Set:

1. Lift the handset or press .
2. Receive intercom dial tone.
3. Dial extension number.



On MLT with Prime Line or Hot Line Set and Intercom key programmed in one touch key:

1. Lift the handset or press .
2. Press the pre-programmed Intercom key.
3. Receive intercom dial tone.
4. Dial extension number.



On MLT with Prime Line or Hot Line Set and ICM key programmed:

1. Lift the handset or press .
2. Press the pre-programmed ICM key.
3. Receive intercom dial tone.
4. Dial extension number

On MLT with Prime Line or Hot Line Set:

1. Lift the handset or press .
2. Press .
3. Receive intercom dial tone, an intercom extension call or directed trunk call (DIT termination, AA termination or DID).
4. Dial extension number.

On SLT with Prime Line or Hot Line Set:

1. Lift the handset or press .
2. Press the  key.
3. Receive intercom dial tone.
4. Dial extension number.

**SERVICE
CONDITION****Data Assignment**



The ICM (Intercom) key is assigned by system programming.



Restrictions



There are no restrictions on intercom call provided the extension exists in the system.

General

The following applies only to Multiline Terminals.

- ④ With a call in progress (internal or trunk call) the user can answer an intercom call or directed trunk call (DIT termination, AA termination, or DID), by pressing ,  or the pre-programmed Intercom key. However, this will terminate the existing call.

- ④ With a call in progress (internal or trunk call) the user can terminate the existing call and start an intercom call by pressing ,  or the pre-programmed Intercom key.

- ④ A call from the door phone can be answered by pressing ,  or the pre-programmed Intercom key.

THIS PAGE INTENTIONALLY LEFT BLANK

Internal Zone Paging (Meet Me)

I-6

FEATURE DESCRIPTION

The Internal Zone Paging feature allows for up to three zones of internal paging. The zones, consisting of Multiline Terminals, can be paged individually or all zones can be paged at once. Any station user can answer the page and speak privately to the originator of the page with the Meet-Me feature.

SYSTEM AVAILABILITY

Terminal type













All terminals.

Required Components



None.

OPERATING PROCEDURES

To originate a page:

1. Press  or lift the handset.
2. Dial the Access Code. Default values are as follows:
 -   - All Internal Zones
 -   - Internal Zone A
 -   - Internal Zone B
 -   - Internal Zone C
 -   - All Internal/External Zones
 -   - Internal/External Meet-Me
3. Use the handset to page.
- OR -
Press a Feature Access key or One-Touch key programmed for one of the above Access Codes.
4. Use handset to page.

To answer a page (Meet-Me):

1. Press  or lift the handset.
2. Dial Access Code   (set as default).
3. Use the handset to talk with party.







**SERVICE
CONDITIONS****Data Assignment**

-  Internal Zone Page times out after 90 seconds (set as default). Timeout options include 90 seconds, 120 seconds, or No Timeout.





Restrictions

-  Multiline Terminal users do not receive internal pages when already engaged in a call.

General

-  Simultaneous zone paging (Internal Zones A, B, and C) can be established; however, All Internal Zone Paging and internal Emergency All Call Paging cannot be performed if any other internal page is in use.
-  A station can be assigned to one Internal Page Zone or it can be assigned to No Zone.
-  Multiline Terminals assigned to No Zone receive any All Internal Zone Pages unless assigned.
-  Internal Emergency All Call and Internal Paging by Tenant Group overrides No Page Receive in System Programming.
-  Single Line Telephone users cannot receive an internal page, but can originate a page and Meet-Me answer.
-  Any station user can answer an internal page if the page was an All Internal Zone Page, Internal Emergency All Call Page, or All Internal/External Zone Page; however, only stations in the Internal Zone Page that were being paged can answer an Internal Zone Page.
-  The All Internal/External Zone Paging uses the Internal Zone Paging timeout.

GUIDE TO FEATURE PROGRAMMING

Order and Shortcut	System Data Name	Memory Block	Function	1-8-07 Attendant Page-Line Key	1-8-08 Station Page-Line Key
 +BA	Access Code (1-, 2-, or 3-Digit) Assignment	1-1-46/47/48	070 ~ 074, 081		
 +BTM	* Internal Zone Paging Selection	4-93			
 +BTT	Receiving Internal/All Call Page Selection	4-31			
 +BP	Internal Paging Alert Tone Selection	1-2-25			
 +BP	Internal Paging Timeout Selection	1-2-00			

* When the system is at default this Memory Block **must** be programmed for the feature to be used.

THIS PAGE INTENTIONALLY LEFT BLANK

ISDN-BRI Trunk Connections

I-7

FEATURE DESCRIPTION

ISDN-BRI (Integrated Service Digital Network - Basic Rate Interface) is a Public Switched Telephone Network (PSTN) service that provides two B channels (2B + D) for voice call trunking. The B channels are used to provide two CO/PBX type connections. Caller ID is a standard feature on ISDN-BRI provided trunks. Caller ID indication displays the calling party telephone number on the LCD of the Multiline Terminal for CO incoming calls. This interface provides voice communication path only.

Malicious Call Trace is available for the Australian Network.

Stimulus type network supplementary services (Keypad mode of operation) is also available.

SYSTEM AVAILABILITY

Terminal Type

Not applicable

Required Components

To provide ISDN trunk connection:

- BRT(4)-U() ETU
- CLKG-U() Unit

OPERATING PROCEDURES

Not applicable.

SERVICE CONDITIONS

Data Assignment

- ④ Use Memory Block 1-1-80 (ISDN DTMF Duration/Interdigit Selection) to specify tone duration (default:100ms.) and interdigit time (default=70ms.) of DTMF signals for the ISDN trunk.
- ④ Use Memory Block 1-1-81 (ISDN Dial Interval Time Selection) to specify the time (default: 4s) between dialled digits.
- ④ Use Memory Block 1-8-33 (Master Clock Selection) to assign the necessary source for synchronisation clocking.
- ④ Use Memory Block 3-29 (Trunk Interval Transmit Pad Selection) to specify Internal Transmit (default: 8 dB) Pad (Volume) control.
- ④ Use Memory Block 3-31 (Trunk External Transmit Pad Selection) to specify External Transmit (default: 0 dB) Pad control.
- ④ Use Memory Block 3-32 (Trunk External Receive Pad Selection) to specify External Receive (default: 9 dB) Pad control.
- ④ Use Memory Block 3-52 (ISDN Trunk Directory Number Assignment) to assign the ISDN directory Number.

- ④ Use Memory Block 3-72 (ISDN BRT Connection Configuration) to assign the BRT Interface as Point to Point or Point to Multipoint (default: Point to Multipoint).
- ④ Use Memory Block 4-47 (ISDN Directory Number Selection) to specify whether or not the directory number is presented to the network.
- ④ Use Memory Block 4-62 (ISDN DID Directory Number Assignment) to specify per station the outgoing Caller ID Number to be presented.
- ④ Use Memory Block 7-1 (Card Interface Slot Assignment) to specify the BRT(4)-U() ETU.

Restrictions

- ④ The ISDN-BRI interface provides a voice communication path only.
- ④ The System does not support Multipoint access.

General

Xen IPK Expanded

- ④ Eight BRT(4)-U() ETUs can be installed in a system.
- ④ Sixty-four ISDN trunks (B channels) can be assigned in a system.
- ④ The BRT(4)-U() ETU can be installed in any slot (1~8) of any cabinet (1~3).

Xen IPK Basic

- ④ Two BRT(4)-U() ETUs can be installed in a system.
- ④ Sixteen ISDN trunks (B channels) can be assigned in a system.
- ④ The BRT(4)-U() ETU can be installed in any slot (1~8) of any cabinet (1~3).















Common

- ④ ISDN Trunk DTMF Duration/Interdigit Selection is effective after Answer Supervision is received from the CO.
- ④ When an ISDN line Layer 1 or Layer 2 down condition occurs, the CO line key LED turns solid red, and the following message is displayed on the first line of the LCD of the Multiline Terminals connected to Port 01:
Layer 1 Down: COXX Layer1 DOWN
Layer 2 Down: COXX Layer2 DOWN
 - ☞ XX represents the CO Trunk number (01~64).
 - ☞ Layer 1 down display has a higher priority than Layer 2 down. This error display disappears automatically when Layer 1/Layer 2 error is recovered.
- ④ The Xen IPK system supports BRI ISDN lines conforming to the ETSI standard.
- ④ The BRT(4)-U() ETU supports the T-interface, but not the U-interface.

- ④ For BRI firmware version 1.35 or higher, Malicious Call Trace is possible provided the class of service is set in the system and is subscribed with the Telstra Network. If only class of services is set in Xen IPK, activating Malicious Call Trace does not mean it has occurred in the Network.
- ④ For BRI firmware version 1.63 or higher, access to network Stimulus Mode supplementary services is possible using Keypad mode of operation.

















GUIDE TO FEATURE PROGRAMMING

CO Line Service

Order and Shortcut	System Data Name	Memory Block	Function	1-8-07 Attendant Page-Line Key	1-8-08 Station Page-Line Key
 +BS	Card Interface Slot Assignment	7-1			
 +AD	* Master Clock Selection	1-8-33			
 +AN	ISDN DTMF Duration/Interdigit Selection	1-1-80			
 +AN	ISDN Dial Interval Time Selection	1-1-81			
 +BCT	Trunk Internal Transmit Pad Selection	3-29			
 +BCT	Trunk Internal Receive Pad Selection	3-30			
 +BCT	Trunk External Transmit Pad Selection	3-31			
 +BCT	Trunk External Receive Pad Selection	3-32			
 +AN	* ISDN Line SPID Assignment	3-50			
 +AN	* ISDN Trunk Directory Number Assignment	3-52			
 +BTM	Line Key Selection for Telephone Mode	4-12			
 +BTT	CO/PBX Ring Assignment (Day Mode)	4-01			
 +BTT	CO/PBX Ring Assignment (Night Mode)	4-02			
 +BTM	Extension Line Key Ring Assignment (Day Mode)	4-37			
 +BTM	Extension Line Key Ring Assignment (Night Mode)	4-38			

* When the system is at default this Memory Block **must** be programmed for the feature to be used.

Calling Party Number (CPN) Service

Order and Shortcut	System Data Name	Memory Block	Function	1-8-07 Attendant Page-Line Key	1-8-08 Station Page-Line Key
 +BS	Card Interface Slot Assignment	7-1			
 +BS	MIF (Caller ID) Assignment	7-3-04			
 + AI	Caller ID Display Assignment for System Mode	1-1-78			
 +BTS	* Class of Service (Station) Feature Selection 2	1-8-08			4-3, 4-4, 5-7, 6-5
 +BCT	DIT Assignment	3-42			
 +BCT	ANA Assignment	3-43			
 + AI	Caller ID Display Assignment for CO/PBX Line	3-44			
 + AI	Caller Name Indication Selection	3-53			
 +BTT	CO/PBX Ring Assignment (Day Mode)	4-01			
 +BTT	CO/PBX Ring Assignment (Night Mode)	4-02			
 +BTM	Line Key Selection for Telephone Mode	4-12			
 +BTT	Station to Class of Service Feature Assignment	4-17			
 +BTM	Extension Line Key Ring Assignment (Day Mode)	4-37			
 +BTM	Extension Line Key Ring Assignment (Night Mode)	4-38			
 + AI	Caller ID Preset Dial Outgoing CO Selection	4-44			
 + AI	Caller ID Display for CAR Key Assignment	4-49			

* When the system is at default this Memory Block **must** be programmed for the feature to be used.

THIS PAGE INTENTIONALLY LEFT BLANK

ISDN-PRI Trunk Connections

I-8

FEATURE DESCRIPTION

This feature allows the system to connect directly to ESTI Primary Rate ISDN Lines. The PRT(1)-U() ETU is required for this facility and allows one connection. Each Primary Rate ISDN connection carries up to 30 channels, providing the system with a total of 30 outside trunks. The use of digital ISDN lines enables voice calls to be made which take advantage of superior voice quality and call security. They may also be more economical than analogue trunks.

Malicious Call Trace is available for the Australian Network.
Network supplementary services via the stimulus (keypad) mode of operation is also available.

SYSTEM AVAILABILITY

Terminal Type

All Stations.

Required Components

PRT(1)-U() ETU

CLKG-U() Unit

OPERATING PROCEDURES

Not applicable.

SERVICE CONDITIONS

Data Assignment for ISDN-PRI Installation

- ④ Use Memory Block 7-1 (Card Interface Slot Assignment) to select the PRT(1)-U() ETU.
- ④ Use Memory Block 1-8-33 (Master Clock Selection) to assign the source for necessary synchronisation of clocking.
- ④ Use Memory Block 1-13-00 (PRT Channel Assignment) to select the available B channels.
- ④ Use Memory Block 1-13-05 (PRT B-Channel Map Assignment) to specify the correspondence between B channels and PRT(CO) trunks.
- ④ Use Memory Block 1-1-80 (ISDN DTMF Duration/Interdigit Selection) to specify the tone duration (default: 100ms) and interdigit time (default: 70 ms) of DTMF signals sent from the ISDN trunk.
- ④ Use Memory Block 3-03 (Trunk-to-Trunk Group Assignment) to assign each ISDN-PRI trunk to a Trunk Group.
- ④ Use Memory Block 3-92 (Trunk Installed, DP/DTMF Selection) to specify each ISDN-PRI trunk as DP or DTMF.

- ④ Use Memory Block 3-91 (Trunk Type Selection) to specify each ISDN-PRI trunk as CO or DID. CO sets ISDN trunks for CO services. DID sets ISDN Trunks for DID services.
- ④ Use Memory Block 3-29 (Trunk Internal Transmit Pad Selection) to specify Internal Transmit volume level (default: 8 dB).
- ④ Use Memory Block 3-30 (Trunk Internal Receive Pad Selection) to specify Internal Receive volume level (default: 8 dB).
- ④ Use Memory Block 3-31 (Trunk External Transmit Pad Selection) to specify External Transmit volume level (default: 0 dB).
- ④ Use Memory Block 3-32 (Trunk External Receive Pad Selection) to specify External Receive volume level (default: 0 dB).

Data Assignment for CO Line Services

- ④ Use Memory Block 3-52 (ISDN Trunk Directory Number Assignment) to assign the ISDN Directory Number.
- ④ Use Memory Block 3-91 (Trunk Type Selection) to specify each ISDN-PRI trunk as CO Lines.
- ④ Use Memory Block 4-12 (Line Key Selection for Telephone Mode) to assign the Trunk Appearance, Route Advance Block or CAP key to line keys for each MLT using ISDN-PRI.
- ④ Use Memory Block 4-01 [CO/PBX Ringing Assignment (Day Mode)] to assign ISDN-PRI trunks to ring during day mode at specified stations.
- ④ Use Memory Block 4-02 [CO/PBX Ringing Assignment (Night Mode)] to assign ISDN-PRI trunks to ring during night mode at specified stations.
- ④ Use Memory Block 1-1-81 (ISDN Dial Interval Time Selection) to specify the time (default: 4s) between dialled digits.

Data Assignment for DID Line Services

- ④ Use Memory Block 3-91 (Trunk Type Selection) to specify each ISDN-PRI trunk as DID Lines.
 - ☞ Refer to D-9 Direct Inward Dialling in the Features and Specifications Manual to convert incoming digits to the correct Station number.

Data Assignments for Caller ID Calling Party Number (CPN)

- ④ Use Memory Block 1-8-08 [Class of Service (Station) Feature Selection 2] Page 4 LK3 to allow (LED ON) or deny (default: LED Off) Caller ID.
- ④ Use Memory Block 1-8-08 [Class of Service (Station) Feature Selection 2] Page 4 LK4 to allow (LED ON) Caller ID Number display or deny (default: LED Off) to display the Caller ID Name when Name and Number are received.

- ④ Use Memory Block 1-8-08 [Class of Service (Station) Feature Selection 2] Page 5 LK7 to allow (LED ON) or deny (default: LED Off) display of both name and number. Page 4 LK4 selects the position of the name or number on the display for the stations assigned to the Class of service.
- ④ Use Memory Block 4-17 (Station to Class of Service Feature Assignment) to assign each station to Class of Service Assignments.

Data Assignments for Calling Party Number (CPN) Presentation from Station

- ④ Use Memory Block 4-47 (ISDN Directory Number Selection) to specify whether or not the station is allowed to present the assigned number in Memory Block 4-62 to the network for Caller ID information when trunks are assigned as DID in Memory Block 3-91.
- ④ Use Memory Block 4-62 (ISDN-PRI Directory Number Selection) to provide individual stations with the 10-digit number to be presented to the ISDN Network when trunks are assigned as DID in Memory Block 3-91. User provided Call screening and presentation may or may not be needed from the ISDN provider.

Restrictions

- ④ The ISDN-PRI interface provides voice communication only.
- ④ The ISDN-PRI interface does not support Multipoint Access.

Restrictions for Calling Party Name and Calling Party Number Presentation from Station

- ④ The Xen IPK can only display 13 characters of the provided Name or Number from the ISDN Network.
- ④ The Xen IPK does not display the name presentation status as private or unavailable.
- ④ When Memory block 4-47 is assigned as YES, and Memory Block 4-62 has a number assigned, the setting in Memory Block 4-62 overrides the number set in Memory Block 3-52 when the station places an outgoing call using PRI.
- ④ PRT trunk types must be assigned as DID in Memory Block 3-91 for Memory Block 4-62 to provide the number to the ISDN Network.
- ④ Incoming calls may display either the Calling Line Identification (CLI) information or the internal Trunk Name information, as specified in system programming (Memory Block 3-00).
- ④ Calling Line Identification Restrictions (CLIR), when set, restricts the caller's line information from being sent on outgoing calls. This can also be accessed by dialling a code using the telephone key pad, on a call by call or station by station basis from analogue or digital phones.
- ④ Outgoing calls display the Exchange Group Directory Number (GDN) if no number is programmed for the B Channel.

Xen IPK Restrictions











- ④ Two PRT(1)-U() ETUs can be installed in a system.
- ④ Up to 60 ISDN trunks (B Channels) can be assigned in a system.
- ④ The PRT(1)-U() ETU can be installed in any slot (1-8) in any cabinet (1-3), except when more than 24 channels are assigned in which case a free slot is required to be left to the right of the slot containing the PRT card.

General





- ④ Each PRT(1)-U() ETU supports the connection of one Primary Rate ISDN line, complying to the European ETSI standard (Australian standard ACA TS038).
 - ④ Memory Block 1-1-80 (ISDN DTMF Duration/Interdigit Selection) is effective after answer supervision is received from the CO.
 - ④ When an ISDN line layer 1 or layer 2 down condition occurs, the CO line key red LED is On, and the following error message is displayed on the first line of the LCD of Multiline Terminals connected to port 1:
 - Layer 1 Down: COxx Layer1 DOWN
 - Layer 2 Down: COxx Layer2 DOWN
 - xx is the CO Trunk Number (01~64)
- Layer 1 has a higher priority than Layer 2. This display disappears automatically when the error is recovered.
- ④ For the Australian Network only, Malicious Call Trace is possible on MLT. This service can only operate when the class of service is assigned and is subscribed with the Telstra Network.
 - ④ The subscription to Malicious Call Trace (MCT) is per interface. That is, to have MCT for more than one PRT(1)-U() in a system, all are required to be subscribed.
 - ④ PRI firmware version 2.12 or higher, access to network supplementary services is possible via the stimulus (Keypad) mode of operation
 - ④ The CLKG-U() Unit must be fitted onto the CPUI-U() ETU when the PRT(1)-U() ETU is installed. The clock unit is a Phase Locked Oscillator which automatically synchronises the Xen IPK system with the ISDN Network. If a BRT(4)-() ETU is also installed in the system, the synchronisation can be provided from either interface. Switch SW1 on the CLKG-U() Unit must be set to the ISDN-PHS setting.
 - ④ The PRT(1)-U() ETU supports DTMF signalling during the conversation phase of the call.

GUIDE TO FEATURE PROGRAMMING







ISDN – PRI Installation

Order and Shortcut	System Data Name	Memory Block	Function	1-8-07 Attendant Page-Line Key	1-8-08 Station Page-Line Key
 +BS	Card Interface Slot Assignment	7-1			
 +AD	Master Clock Selection	1-8-33			
 +AN	ISDN DTMF Duration/Interdigit Selection	1-1-80			
 +AN	PRT Channel Assignment	1-13-00			
 +AN	PRT B Channel-to-Trunk Group Assignment	1-13-05			
 +BCT	Trunk-to-Trunk Group Assignment	3-03			
 +BCT	Trunk Internal Transmit Pad Selection	3-29			
 +BCT	Trunk Internal Receive Pad Selection	3-30			
 +BCT	Trunk External Transmit Pad Selection	3-31			
 +BCT	Trunk External Receive Pad Selection	3-32			
 +BCT	Trunk Type Selection	3-91			







CO Line Service

Order and Shortcut	System Data Name	Memory Block	Function	1-8-07 Attendant Page-Line Key	1-8-08 Station Page-Line Key
 +BCT	Trunk Type Selection	3-91			
 +AN	* ISDN Trunk Directory Number Assignment	3-52			
 +BTT	CO/PBX Ring Assignment (Day Mode)	4-01			
 +BTT	CO/PBX Ring Assignment (Night Mode)	4-02			
 +BTM	Line Key Selection for Telephone Mode	4-12			



DID Line Service

Order and Shortcut	System Data Name	Memory Block	Function	1-8-07 Attendant Page-Line Key	1-8-08 Station Page-Line Key
 +BCT	* Trunk Type Selection	3-91			
 +ALN	Digit Add/Delete for Tie Line Networking Assignment	5-00			
 +ALN	DID Digit Length Selection	1-1-20			
 +ALN	DID Digit Conversion Assignment	1-1-21			
 +ALN	DID Digit Conversion Table	1-1-22			
 +ALN	DID Forward Station Number for Busy Station or Undefined Digit	1-1-23			

Calling Party Number (CPN) Service

Order and Shortcut	System Data Name	Memory Block	Function	1-8-07 Attendant Page-Line Key	1-8-08 Station Page-Line Key
 +BS	MIF (Caller ID) Assignment	7-3-04			
 +AI	Caller ID Display Assignment for System Mode	1-1-78			
 +BTS	Class of Service (Station) Feature Selection 2	1-8-08			4-3, 4-4, 5-7, 6-5
 +AI	Caller ID Display Assignment for CO/PBX Line	3-44			
 +BTT	Station to Class of Service Feature Assignment	4-17			
 +AI	Caller ID Preset Dial Outgoing CO Selection	4-44			
 +AI	Caller ID Display for CAR Key Assignment	4-49			

Calling Party Number (CPN) Presentation from Station

Order and Shortcut	System Data Name	Memory Block	Function	1-8-07 Attendant Page-Line Key	1-8-08 Station Page-Line Key
 +BCT	* Trunk Type Selection	3-91			
 +AN	ISDN Directory Number Selection	4-47			
 +AN	* ISDN-PRI Directory Number Selection	4-62			

THIS PAGE INTENTIONALLY LEFT BLANK

ISDN Supplementary Services

I-9

FEATURE DESCRIPTION

This feature allows a Multiline telephone user to access the various supplementary services which may be available on your ISDN network. The types of supplementary services which can be accessed are those which can be activated using the Stimulus (Keypad) mode of operation. Consult your ISDN service provider for further details.

SYSTEM AVAILABILITY

Terminal Type

All Multiline Terminals.

Required Components

PRT(1)-U() ETU

BRT(4)-U() ETU

CLKG-U() Unit

OPERATING PROCEDURES

Assigning a key to activate network supplementary services from a MLT:





1. Press **Feature** .
2. Press **Redial** .
3. Press the Feature Access key.
4. Dial ***** .
5. Dial **0** **1** .
6. Press **Feature** .

Activating network supplementary services from a MLT.

1. Press **Linekey** or dial a Trunk Access Code (0 or 63x) to seize an ISDN trunk.
2. Press the Feature Access Key programmed as the Supplementary Services key.
3. Refer to your ISDN service provider's supplementary services handbook for details of the individual features available.
4. Press the Feature Access Key programmed as the Supplementary Services key or hang up.

To Activate Malicious Call Trace from a MLT:

Before termination of the call;

1. Press    , or the assigned feature access key.

If allowed in Class of Service, the MLT LCD displays "MCT INITIATED". However, if the facility is not subscribed within the network, no call trace will result.

SERVICE CONDITIONS

Data Assignment

- ④ Use Memory Block 1-8-08 (Class of Service (Station) Feature Selection 2), Page 6: LK 4, to assign Supplementary Services access to stations via Feature Class of Service.
- ④ Use Memory Block 1-1-85 (ISDN Stimulus Method Selection) to specify whether the system is being used in Australia or New Zealand.
- ④ Use Memory Block 3-72 (ISDN BRT Connection Configuration) to assign the BRT interface as Point-to-Point or Point-to-Multipoint (default: Point-to-Multipoint).

General

- ④ This feature provides access to various Supplementary Services provided by the ISDN network only. BRI or PRI ISDN trunks must therefore be installed in the system.
- ④ Depending on the ISDN network to which you are connected, there may be no service tones returned from the network upon setting a feature. The Xen IPK system does not provide tones or any other indications to indicate feature status.
- ④ Performing the procedure on a station for which the setting of Supplementary Services is not allowed by the Class of Service, does not allow the user to activate supplementary services.
- ④ Pressing the Supplementary Services Key or performing the procedure to disconnect the line during the setting of Supplementary Services enables the user to exit from this mode.
- ④ Supplementary Services can be assigned to a Line Key assigned as a one-touch or a DSS key. However, it must not be registered twice on the same handset.
- ④ The Supplementary Services key can be registered only on a station allowed by the Class of Service. The Supplementary Services key already registered is retained however if it is then restricted by Class of Service.
- ④ When the Supplementary Services key is pressed other than while seizing an ISDN trunk, it will respond depending on the type of key to which it has been allocated; One-touch key = ERROR displayed; DSS key = None displayed.

I-Use Indication

I-10

FEATURE DESCRIPTION

The I-Use Indication feature provides a green LED line key indication for the line being used on Multiline Terminals. Other busy line keys are shown with red LEDs. This quickly identifies the line being used by the station user.

SYSTEM AVAILABILITY

Terminal Type

All Multiline Terminals.

Required Components

None.

OPERATING PROCEDURES

No manual operation required.

SERVICE CONDITIONS

General

- ④ The indication provided is a green LED when a CO/PBX line is in use or a winking green LED when the line is on hold.
- ④ All other Multiline Terminals with that line appearance show a red lit LED.
- ④ When a Multiline Terminal does not have a CO/PBX line appearance on a Flexible Line key, the I-Use is indicated on a Call Appearance Key LED.
- ④ When a Multiline Terminal has the CO/PBX line appearance on a Flexible Line key, the I-Use indication is indicated on the CO/PBX line key.

THIS PAGE INTENTIONALLY LEFT BLANK

Key Function/Multifunction Registration

K-1

FEATURE DESCRIPTION

The system can be registered as either a Key Function (KF) or a Multifunction (MF) telephone system. This feature is set via a switch on the CPU()-U() ETU at the time of installation.

SYSTEM AVAILABILITY

Terminal Type
Not applicable.

Required Components
CPU()-U() ETU

OPERATING PROCEDURES

Not applicable.

SERVICE CONDITIONS

General

- ④ When the system is set as KF, CO/PBX lines must appear on Multiline Terminals. Outside calls cannot be made by dialling a Trunk Access Code from internal dial tone except when specified trunk seizure is used.
- ④ When a system is set as KF, the following CO/PBX calls are prohibited:
 - Route Advance key
 - Trunk Group key
 - Hot Line/Prime Line with Automatic Trunk Selection
 - Trunk Group Access Call, Route Advance Access Call
 - Least Cost Routing (LCR)
 - Speed Dial with Automatic Trunk Selection
 - Last Number Redial with Automatic Trunk Selection
- ④ When the system is set as multifunction, CO/PBX lines can be accessed from internal dial tone by dialling a Trunk Access Code.
- ④ KF or MF selection is set by a hardware switch on the CPU()-U() ETU. To change the KF/MF selection after First Initialisation of the system, First Initialisation must be performed again.
- ④ In KF mode, Single Line Telephones can be used for internal calls and can access an outside line using the specified trunk seizure Access Code or Prime Line Pickup assignment.

THIS PAGE INTENTIONALLY LEFT BLANK

Large LED Indication

L-1

FEATURE DESCRIPTION

All Multiline Terminals are equipped with a Large LED to indicate incoming calls or messages that have been sent from the Attendant or a Voice Mail system.

SYSTEM AVAILABILITY

Terminal Type
All Multiline Terminals.

Required Components
None.

OPERATING PROCEDURES

Not applicable.

SERVICE CONDITIONS

Visual Indications for the Large LED include the following:

Incoming CO/PBX Call	Flashing Green	0.125 sec. ON 0.125 sec. OFF
Incoming internal Call	Flashing Red	0.125 sec. ON 0.125 sec. OFF
Message from Attendant Add-On Console	Flashing Green	0.5 sec. ON 0.5 sec. OFF
Message from Voice Mail	Flashing Red	0.5 sec. ON 0.5 sec. OFF
CO Ring Transfer Calls	Flashing Green	0.125 sec. ON 0.125 sec. OFF

Calls are in the following priority order:

1. Internal
2. CO Ring Transfer
3. CO/PBX
4. Message from Voice Mail
5. Message from Attendant Add-On Console

THIS PAGE INTENTIONALLY LEFT BLANK

Last Number Redial

L-2

FEATURE DESCRIPTION

The Last Number Redial feature is used to redial the last outside number the user dialed by pressing the Redial key and $\#$. This is useful when a busy or no answer is received when trying to place a CO/PBX call.

SYSTEM AVAILABILITY

Terminal Type
All terminals.

Required Components
None.

OPERATING PROCEDURES

To use this feature from a Multiline Terminal:

KEY FUNCTION

1. Press an idle CO/PBX/Tie line key.
2. Press .
3. Dial $\#$.

MULTIFUNCTION (DIAL ACCESS)

1. Press .
2. Dial $\#$.

To use this feature from a Single Line Telephone:

Multifunction (Dial Access) Only

1. Lift the handset to receive internal dial tone.
2. Dial $\#$ (set as default).

SERVICE CONDITIONS

Data Assignment

- ☎ The Last Number Redial Access Code (default #) can be changed in System Programming.

Restrictions

- ☎ Internal calls do not apply to this feature.

General

- ☎ Last Number Redial memory is protected by battery backup.
- ☎ Last Number Redial stores up to 24 digits (plus the Trunk Access Code).
- ☎ The Access Code # is fixed in system software for use with the Redial key.
- ☎ This feature can be assigned to a Feature Access or One-Touch key.
- ☎ The Last Number Redial memory buffer can be displayed by pressing the Conf key, Redial key, and then #.
- ☎ A Private Line must be accessed by Direct CO access for Redial to operate.
- ☎ Manually dialled numbers, Speed Dial numbers, Save/Store and Repeat numbers, One-Touch dial numbers, or their combinations can be redialled via the Last Number Redial feature if the last number dialled was less than 24 digits.
- ☎ A Trunk Access Code is automatically inserted if the last call was made by manually selecting an outside line.

GUIDE TO FEATURE PROGRAMMING

Order and Shortcut	System Data Name	Memory Block	Function	1-8-07 Attendant Page-Line Key	1-8-08 Station Page-Line Key
 +BA	Access Code (1-, 2-, 3-Digit) Assignment	1-1-46/47/ 48	096		

Least Cost Routing (LCR)

L-3

FEATURE DESCRIPTION

The Least Cost Routing feature routes outside calls to the least expensive route available. The MIFM-U() ETU and KMM()UA provides cost effective call routing based on the time of day, day of week, or holiday based on the Central Office number dialed. This option minimises call costs by automatically selecting the least expensive available connection for outgoing calls.

SYSTEM AVAILABILITY

Terminal Type
All terminals.

Required Components
MIFM-U() ETU
KMM()UA

OPERATING PROCEDURES

To use this feature

1. Lift the handset and receive internal dial tone.
2. Dial the Code 0 and receive LCR dial tone.
3. Dial the desired number.

SERVICE CONDITIONS

Data Assignment

- ☎ LCR can be programmed by time-of-day, day-of-week, or holiday.
- ☎ All Trunk groups in the system (except 00) can be accessed using LCR.
- ☎ Trunk groups 2~32 are programmable to bypass LCR at stations assigned for LCR.
- ☎ Local Call Override of LCR is available.
- ☎ The Priority Selection in the Route Advance Table is set in System Programming.









Restrictions

- ☎ Route Advance Blocks assigned on a line key bypass LCR.
- ☎ If the Xen IPK system is designated as KF registration, this feature is not available.
- ☎ Outgoing calls via DISA cannot access LCR.

General

- ④ LCR access is assigned per station in LCR Class Selection.
- ④ LCR is programmed via a Personal Computer and diskette through the MIFM-U() ETU. This connection is the same as the PC programming connection.
- ④ Trunk Group Access Code (0 set as default) activates LCR at stations assigned for LCR.
- ④ LCR is based on the first eight digits dialed.
- ④ When using Code Restriction with LCR, Code Restriction is applied to the digits dialed by the system.
- ④ Extra Code Tables can be programmed to provide Trunk Access Codes, OCC Access Codes, and pauses for the distant-end system.
- ④ The maximum number of extra code digits is 32, including pauses (each pause counts as one digit).
- ④ LCR provides up to eight different routes for each call.
- ④ If the station user seizes the most expensive trunk, alarm tone is not provided.
- ④ When the interdigit time exceeds 10 seconds, the outgoing call, via LCR, is disconnected.
- ④ When the station user places an outside call using LCR, Trunk Queuing cannot be set.

GUIDE TO FEATURE PROGRAMMING

Order and Shortcut	System Data Name	Memory Block	Function	1-8-07 Attendant Page-Line Key	1-8-08 Station Page-Line Key
 +BS	* Card Interface Slot Assignment	7-1			
 +BS	* MIF (LCR) Assignment	7-3-01			
 +BA	* Access Code (1-, 2-, or 3-Digit) Assignment	1-1-46/47/ 48	101		
 +BTS	Class of Service (Station) Feature Selection 2	1-8-08			3-4
 +BTT	* LCR Class Selection	4-40			
 +BTT	Station to Class of Service Feature Assignment	4-17			
 +BCT	Trunk Type Selection	3-91			
 +BCT	* Trunk-to-Trunk Group Assignment	3-03			
 +BI	Tone Assignment	1-8-15	Tone Table 10		

* When the system is at default this Memory Block **must** be programmed for the feature to be used.

THIS PAGE INTENTIONALLY LEFT BLANK

FEATURE DESCRIPTION

Xen Multiline Terminal users can listen to voice mail messages as the message is being recorded by the XenMail VMS/FMS. The Live Monitoring feature is password protected and can be used in automatic or manual mode. When Live Monitoring is in use, the audio is played from the Multiline Terminal Speaker. The terminal user can pick up the handset and speak to the caller anytime during the recording.

SYSTEM AVAILABILITY

Terminal Type

All Multiline Terminals with soft keys.

Required Components

VMS (2/4/8)-U() ETU

FMS (2/4)-U() ETU

OPERATING PROCEDURES

To enable Live Monitoring

1. Press the feature access key assigned as Live Monitoring.
2. Live Monitoring key flashes red while this feature is being set.
3. Dial the password (same as Station Outgoing Lockout password; default is 0000000000).

To operate Manual Live Monitoring while the caller is leaving a voice mail message

1. Press the Start soft key while the CO caller is leaving a message.
2. Press the Cancel softkey to stop Live Monitoring.

- OR -

Pick up handset to retrieve the call from voice mail.

To stop Live Monitoring while the caller is leaving a voice mail message in Automatic mode

Press the Cancel soft key.

- OR -

Press the Live Monitoring feature access key.

To cancel the Live Monitoring Feature when not in use

Press the Live Monitoring Feature Access key.

To retrieve a call during the Live Monitoring Feature

Pick up the handset.

- OR -

Press .

**SERVICE
CONDITIONS****Data Assignment**





- ④ The Live Monitoring feature key is required for feature operation. The terminal user can assign the key on a Feature Access or One-Touch key. Feature code for Live Monitoring is 07.
- ④ Voice Mail must have Live Monitoring set per mailbox for one of the following.
 - Manual Mode
 - Automatic Mode
 - Not Available (Default)

Restrictions



- ④ Live Monitoring is not available for internal calls but is available for the following outside calls.
 - Calls forwarded to Voice Mail
 - Calls transferred to Voice Mail
 - DIT/DID calls to Voice Mail
- ④ Manual Mode is available only on terminals with soft keys.
- ④ Live Monitoring is not available for the following conditions.
 - During an internal call to a station
 - When a station places a conference call on hold
 - For Voice Mail messages sent to multiple mailboxes
 - For Voice Mail messages sent to mailboxes that do not correspond to the actual station number.

- ⓘ If DND, Call Forward - All Call, or Station Outgoing Lockout is set during Live Monitoring Mode, the Live Monitoring mode is cancelled. If required, a station user must set up Live Monitoring mode after setting Call Forward - All Call.
- ⓘ Live Monitoring calls cannot be picked up by Call Pickup feature.

General

- ⓘ Visual indications for Live Monitoring line key LED include the following.
 - Red flash Setting up Live Monitoring Mode
 - Red steady In Live Monitoring Mode (Station is available to receive Live Monitoring)
 - Green steady When Live Monitoring is playing through Multiline Terminal
- ⓘ When the Live Monitoring key is assigned on a One-Touch or Feature-Access key, the key toggles Live Monitoring on/off.
- ⓘ When multiple calls are recording to the same mailbox, user can Live Monitor the first call only.
- ⓘ If you press , ,  or  key, or a Line/Feature Access key, Live Monitoring is cancelled and the function of the key you pressed is activated.
- ⓘ Live Monitoring can be turned ON or OFF using the personal settings when using Softkeys.
- ⓘ Automatic Mode and Manual Mode for Live Monitoring can be toggled between settings using Softkeys.

GUIDE TO FEATURE PROGRAMMING

Order and Shortcut	System Data Name	Memory Block	Function	1-8-07 Attendant Page-Line Key	1-8-08 Station Page-Line Key
 +BS	Card Interface Slot Assignment	7-1			
 +BTM	Line Key Selection for Telephone Mode	4-12			
 +BTS	* Class of Service (Station) Feature Selection 2	1-8-08			5-6

* When the system is at default this Memory Block **must** be programmed for the feature to be used.

Doc. No. 8201 - Release 1.0
July 2003

THIS PAGE INTENTIONALLY LEFT BLANK

Loop Start Trunks

L-5

FEATURE DESCRIPTION

Loop Start Trunks can be connected to the Xen IPK system via the COI ()-U() ETU or COID()-U() ETU.

SYSTEM AVAILABILITY

Terminal Type
Not applicable .

Required Components
COI()-U() ETU or COID()-U() ETU

OPERATING PROCEDURES

Not applicable.

SERVICE CONDITIONS

General

- ⓘ If the serving CO sends a disconnect signal when the outside party abandons a call, the trunk is automatically released.
- ⓘ Sixty-four trunks (Loop Start, ISDN, E&M Tie Lines, and DID Trunks) can be installed in the Xen IPK Expanded system or 16 trunks in a Xen IPK Basic system.

GUIDE TO FEATURE PROGRAMMING

Order and Shortcut	System Data Name	Memory Block	Function	1-8-07 Attendant Page-Line Key	1-8-08 Station Page-Line Key
 +BS	Card Interface Slot Assignment	7-1			

THIS PAGE INTENTIONALLY LEFT BLANK

Message Waiting

M-1

FEATURE DESCRIPTION

A locally provided music source or an internal music source can be used to supply music to parties on hold, to assure them that they are still connected to the system.

System Software allows CO ports to provide multiple music sources to different COs in the system.

SYSTEM AVAILABILITY

Terminal Type

All terminals that are assigned on the Attendant Add-On Console, except Single Line Telephones supported by an SLT Adapter.

Required Components

DCU-60-1A(WH)/DCR-60-1A() for Attendant Message Waiting.
Voice Mail Unit for Voice Mail Message Waiting.

OPERATING PROCEDURES

To set a Message from the Attendant Position using the Attendant Add-On Console:

1. Press the Message key on the Attendant Add-On Console.
2. Press the DSS key on the Attendant Add-On Console that is associated with the station where Message Waiting indication is to be set.

To cancel a Message from the Attendant Position using the Attendant Add-On Console:

1. Press the Message key on the Attendant Add-On Console.
2. Press the DSS key on the Attendant Add-On Console that is associated with the station where Message Waiting is to be cancelled.

To respond to Message Waiting indication:

Dial  or the associated Attendant station with the Attendant Add-On Console used to set the message.

- OR -



Call the Voice Mail System and retrieve the messages.

SERVICE CONDITIONS

General

- ④ A Message Waiting indication can be identified on the large LED on the recipient Multiline Terminal. Message Waiting indications from the Attendant Add-On Console flash green; indications from a Voice Mail Unit flash red.
- ④ To confirm a Message Waiting indication at an Attendant Add-On Console, ensure that the green LED associated with the station is lit. A Message Waiting indication remains on until the message is cancelled at the Attendant Add-On Console where it was set.
- ④ When two or more (system maximum of four) Attendant Add-On Consoles are installed, the message is displayed only on the Attendant Add-On Console where the setting was made.
- ④ All Attendant Add-On Consoles can be used to set a Message Waiting to the same station.
- ④ Single Line Telephones supported by an SLI(8)-U() ETU with a Message Waiting LED receive a flashing Message Waiting indication when set.
- ④ Message Waiting from an Attendant Add-On Console has higher priority than Message Waiting from a Voice Mail Unit.
- ④ An Attendant Add-On Console with a Message Waiting key assigned on it cannot be used to set the Attendant Station Outgoing Lockout feature.
- ④ Message Waiting status is retained in memory by the memory backup battery.

GUIDE TO FEATURE PROGRAMMING

Order and Shortcut	System Data Name	Memory Block	Function	1-8-07 Attendant Page-Line Key	1-8-08 Station Page-Line Key
 +BTD	Attendant Add-On Console to Telephone Port Assignment	1-6-01			
 +BTD	Attendant Add-On Console Key Selection	1-6-05			

Microphone Control

M-2

FEATURE DESCRIPTION

The Microphone Control feature allows microphone control with ON/OFF status indication on all Multiline Terminals. A Flexible Line key or One-Touch key programmed for Microphone Control or an Access Code is used to mute the microphone for privacy during incoming voice announcement calls and during calls using the built-in speakerphone.

D^{term} Series i Multiline Terminals have a dedicated MIC key for this purpose.

SYSTEM AVAILABILITY

Terminal Type

All Multiline Terminals.

Required Components

None.

OPERATING PROCEDURES

When using the D^{term} Series i Multiline Telephone:

1. When the MIC LED is off, press the dedicated MIC key to turn the MIC LED on and to activate the microphone.
2. When the MIC LED is on, press the dedicated MIC key to turn the MIC LED off and to deactivate the microphone.

When the MIC ON/OFF feature is assigned on Feature Access key or a One-Touch key on a Flexible Line key:

1. When the MIC LED is off, press the MIC key to turn the MIC LED on and to activate the microphone.
2. When the MIC LED is on, press the MIC key to turn the MIC LED off and to deactivate the microphone.

When the MIC ON/OFF feature is not assigned on a Feature Access key or a One-Touch key:

When the MIC LED is off

1. Press **Feature**.
2. Dial Access Code **1**.
3. The MIC LED goes on.

When the MIC LED is on

1. Press **Feature**.
2. Dial Access Code **1**.
3. The MIC LED goes off.

**SERVICE
CONDITIONS**

General

- ④ D^{term} Series i Multiline Terminals have a built-in MIC key.
- ④ The MIC key controls the built-in microphone during handsfree mode and controls the handset mute feature during handset/headset operation.
- ④ The microphone is activated when the MIC LED is lit, and an internal voice signal call is made to a Multiline Terminal.
- ④ If full handsfree is denied in System Programming, Handsfree Dialling/Monitoring does not activate the microphone.
- ④ The microphone status is indicated by the LED labelled MIC (not the Flexible Line key, if assigned). When the MIC LED is on, the microphone is on.

**RELATED
FEATURES LIST**

Feature Number	Feature Name
F-7	Full Handsfree Operation
H-1	Handset Mute
H-2	Handsfree Answerback

**GUIDE TO
FEATURE
PROGRAMMING**

Order and Shortcut	System Data Name	Memory Block	Function	1-8-07 Attendant Page-Line Key	1-8-08 Station Page-Line Key
 +BTM	Line Key Selection for Telephone Mode	4-12			

THIS PAGE INTENTIONALLY LEFT BLANK

Multiline Conference Bridge

M-3

FEATURE DESCRIPTION

The Multiline Conference Bridge allows any intercom or outside caller to call the CNF(8)-U() ETU to place a multiparty conference call. Each CNF(8)-U() ETU supports one 8-party conference or two 4-party conferences regulated by a switch setting. Up to two CNF(8)-U() ETUs may be installed. DSP based amplification provides a higher quality conference call.

SYSTEM AVAILABILITY

Terminal Type







All Terminals.

Required Components





CNF(8)-U() ETU

OPERATING PROCEDURES





To set the Supervisor Password:

1. Call the Conference Bridge extension number and wait for the voice prompt.
2. Dial the default Supervisor Password (   ), then  .
3. Follow the voice prompt, and enter the setting verification mode (). Then enter system set mode.
4. Follow the voice prompt to change Supervisor Password (4~8 digits).

To set the Conference 1 and/or Conference 2 Password:

1. Call the Conference Bridge extension number and wait for the voice prompt.
2. Dial the default Supervisor Password (   ), then  .
3. Skip the steps until Conference Setup mode is available for conference 1 or conference 2.
4. Follow the voice prompt and set the conference 1 or the conference 2 password (4~8 digits).

To record new Customised Greeting:

1. Call the Conference Bridge extension number and wait for the voice prompt.
2. Dial the default Supervisor Password (   ), then  .
3. Skip options until the Customised Greeting option selected.
4. Follow the voice prompt and record a new Customised Greeting.

To start Conference Call from an internal extension:

1. Call the Conference Bridge extension number.
2. When you hear the voice prompt, enter the Conference Bridge 1 or 2 password and press  .
3. Start the conference call.

To start Conference Call from an outside DID call:

1. Call DID number for the Conference Bridge.
2. When the voice prompt is heard, enter the Conference Bridge 1 or 2 password and press  .
3. Start the conference call.

To start Conference Call from an outside DIT call:

1. Call a trunk that is set as DIT to Conference Bridge.
2. When the voice prompt is heard, enter the Conference Bridge 1 or 2 password and press  .
3. Start the conference call.

To start a conference call from an incoming CO call using an Automated Attendant:

1. Call a trunk that is set as Automated Attendant.
2. Select the option for an extension connected to the Conference Bridge.
3. When the voice prompt is heard, enter the Conference Bridge 1 or 2 password and press **#**.
4. Start the conference call.

To start a conference call from an incoming CO call using an Attendant:

1. Call the Attendant and ask to be transferred to an extension connected to the Conference Bridge.
2. When the voice prompt is heard, enter the Conference Bridge 1 or 2 password and press **#**.
3. Start the conference call.

SERVICE CONDITIONS

Data Assignment

- ☎ The CNF(8)-U() ETU must be assigned as an SLI(8)-U() ETU using Memory Block 7-1.
- ☎ The ports connected to the CNF(8)-U() ETU must be assigned as voice mail ports using Memory Block 4-35 to ensure proper disconnect signals.
- ☎ All ports that are set to the same conference group should be set to the same Master Hunt Group using Memory Blocks 4-14 and 4-15.
- ☎ When CNF is set for two, four-party conferences, ports 1~4 should be set to the same Master Hunt Group, and ports 5~8 should be set to a different Master Hunt Group using Memory Blocks 4-14 and 4-15. This allows two different Pilot Numbers for each conference.

- OR -









If only one Pilot Number is needed, out all eight ports in one hunt group using Memory Block 4-15. When the password is entered, the conference selected is the conference you enter.

- ☎ DIT assignment may be set to Master Hunt Group using Memory Block 3-42 for Day or 3-43 for night.

Restrictions

- ④ The supervisor must perform the Setting Procedures before the conference Bridge can be used.
- ④ Up to 16 analogue voicemail ports are available. The CNF(8)-U() ETU reduces this number by 8.
- ④ Each CNF(8)-U() ETU reduces the number of stations and CAR keys by 8.
- ④ It is the characteristic of the network that audio losses of up to 6dB may be experienced over analogue PSTN services, depending on the length of the line back to the local exchange. When analogue lines are incorporated into a conference, the end to end loss can therefore add up to 12dB. This loss is significant and may not be able to be compensated for by the Automatic Gain Control (AGC) facility of the Xen IPK conference card, resulting in some conversations being low in volume. Such losses should not be experienced when using ISDN lines. Therefore, in order to ensure audio levels are maintained at acceptable levels, NEC recommend to use ISDN lines where possible, for all conference parties.

GUIDE TO FEATURE PROGRAMMING

Order and Shortcut	System Data Name	Memory Block	Function	1-8-07 Attendant Page-Line Key	1-8-08 Station Page-Line Key
 +BS	Card Interface Slot Assignment	7-1			
 +BTI	* Voice Mail/SLT Selection	4-35			
 +BS	Station Number Assignment	4-10			
 +BTT	* Intercom Master Hunt Number Selection	4-14			
 +BTT	* Intercom Master Hunt Number Forward Assignment	4-15			
 +BTT	Station Name Assignment	4-18			
 +BCT	DIT Assignment	3-42			
 +BCT	ANA Assignment	3-43			

* When the system is at default this Memory Block **must** be programmed for the feature to be used.

Multilingual LCD Indication

M-4

FEATURE DESCRIPTION

The Multilingual LCD indication feature provides the option for English, French, Spanish or Japanese characters on Multiline Terminals that have an LCD. Language selection is made per station via System Programming.

SYSTEM AVAILABILITY

Terminal Type
Multiline Terminals with LCD.

Required Components

None.

OPERATING PROCEDURES

Not applicable.

SERVICE CONDITIONS



Data Assignment

- Language selection is set for English by default.

General

- Multilingual Indication per station only applies for fixed LCD messages.
- Programmable messages such as station name and Customised Messages are programmed per message.

GUIDE TO FEATURE PROGRAMMING

Order and Shortcut	System Data Name	Memory Block	Function	1-8-07 Attendant Page-Line Key	1-8-08 Station Page-Line Key
 +BTM	* Multilingual LCD Indication Selection	4-28			
 +BTT	Station Name Assignment	4-18			
 +BI	Customised Message 1~10 Assignment	1-2-09 ~ 18			

* When the system is at default this Memory Block **must** be programmed for the feature to be used.

THIS PAGE INTENTIONALLY LEFT BLANK

Multiple Trunk Groups

M-5

FEATURE DESCRIPTION

A maximum of 32 Trunk groups may be assigned. Each group can have a separate Trunk Group Access Code. Assigning Trunk groups provides access to different types of outside trunks. With Tenant Service, different tenants can be programmed to access only their Trunk groups.

SYSTEM AVAILABILITY

Terminal Type

All terminals.

Required Components

None.

OPERATING PROCEDURES

To use this feature from any station:

1. Lift the handset; receive internal dial tone.
2. Dial the Trunk Group Access Code.
3. Receive outside dial tone.
4. Dial the desired telephone number.

SERVICE CONDITIONS

Data Assignment

- ☎ Trunk groups can be assigned a Dial Access Code (up to three digits). Trunk Access Codes are programmable.
- ☎ Default Trunk Access Codes include the following:
 - Dial 81 = Trunk Group 1
 - Dial 82 = Trunk Group 2
 - Dial 83 = Trunk Group 3
 - Dial 84 = Trunk Group 4
 - Dial 85 = Trunk Group 5



Restrictions

- ☎ A trunk can be assigned to only one Trunk group in System Programming.

General

- ④ Dial Access is provided only on systems registered as Multifunction.
- ④ At default, CO/PBX/ISDN lines 01~ 08 are assigned in Trunk Group 1, all Tie lines are assigned in Trunk group 2, and all additional CO/PBX/ISDN lines and DID lines are not assigned to a Trunk group.
- ④ The system provides for 32 Trunk groups. Any number of trunks, up to 64, can be in a Trunk group.
- ④ Trunks can be assigned to any or all Tenant groups.
- ④ Various features such as Code Restriction (outgoing), LCR, and Route Advance Block are based on Trunk groups.
- ④ Trunk groups can be assigned to a Flexible Line key as a Pooled Line (outgoing).

GUIDE TO FEATURE PROGRAMMING

Order and Shortcut	System Data Name	Memory Block	Function	1-8-07 Attendant Page-Line Key	1-8-08 Station Page-Line Key
 +BCT	Trunk-to-Trunk Group Assignment	3-03			
 +BA	Access Code (1-, 2-, or 3-Digit) Assignment	1-1-46/47/ 48	101 ~ 132		

Multi-Zone Digital Cordless

M-6

FEATURE DESCRIPTION

The PHS Multi-zone Digital Cordless system is essential for busy people on the move. Using a series of internally placed micro cellular repeater stations, you can move around freely within the workplace and always be in contact, with no mobile call charges. Best of all, the super compact, lightweight handset enables you to access all the main Xen IPK communications functions, including call transfer and XenMail.

A BSU(2)-U() ETU interfaces the KSU to an antenna unit called Base Station (BS). These units are placed throughout the facility to manage calls through a network for wireless communication using the *D^{term}* Drovers PHS handsets.

SYSTEM AVAILABILITY

Terminal Type

D^{term} Drovers Handsets.

Required Components

CLKG-U() UNIT

BS21(AU)-ID

BS21(AU)-ND

BSU(2)-U() ETU

OPERATING PROCEDURES

Refer to the *D^{term}* Drovers PHS handset user guide.

FEATURES

ANNOUNCEMENT - PS NO ANSWER/ANNOUNCEMENT - PS OUT OF ZONE

This feature allows a call from a *D^{term}* Drovers that cannot be paged in a programmed time to be routed to a display that indicates the *D^{term}* Drovers is Out of Zone and cannot be answered.

AUTOMATIC RELEASE - OUT OF ZONE CALLS

When a *D^{term}* Drovers caller either crosses the service area boundary or enters a zone where all channels are busy and communication is impossible, the call is disconnected automatically, and the other party receives reorder tone or Out of Area display.

CALL FORWARDING

When a *D^{term}* Drover is powered off or Out of Zone, a call directed to it is forwarded to a VMS, and a message can be recorded to the VMS and checked from the *D^{term}* Drover. The VMS can page the *D^{term}* Drover automatically after the Voice Mail message is recorded.

CALLING NAME DISPLAY - *D^{term}* Drover

When an incoming call is ringing, or a hold call terminates on the *D^{term}* Drover, the calling party name is displayed on the LCD.

CALLING NUMBER DISPLAY - *D^{term}* Drover

This feature allows the Station Number of an incoming call to be displayed on the LCD of the *D^{term}* Drover receiving the call.

DTMF SIGNAL SENDER

This feature allows a *D^{term}* Drover user to send a DTMF tone to the called party terminal or Voicemail.

HAND OVER

When signal transmission quality becomes a problem, the *D^{term}* Drover originates another call automatically to seize another radio channel and force the system to handover the call to another base station to maintain quality.

INDIVIDUAL *D^{term}* DROVER CALLING

The calling party can page the individual *D^{term}* Drover. If the calling number is available, the lower number digits are displayed on the LCD of the called *D^{term}* Drover. The called *D^{term}* Drover user can then press LK1 to answer.

LAST NUMBER REDIAL

The *D^{term}* Drover user can store the number for the previous five calls. The stacked numbers are sequentially displayed on the LCD to allow the user to make an outgoing call by selecting the desired number from the display.

OUT OF ZONE INDICATION

A warning tone and LCD display indicate when the *D^{term}* Drover user moves out of the service area.

OVERLAP DIALLING

The *D^{term}* Drover user accesses dial tone and then dials the indicated number to originate a call.

PRESET DIALLING

The *D^{term}* Drover user can confirm the number to be dialled before originating a call.

PS AUTHORIZATION

The D^{term} Drover user can confirm the identity to prevent an unauthorized D^{term} Drover from accessing the system. Identity is confirmed between the system and D^{term} Drover by checking the unique key information of the D^{term} Drover.

PS LOCATION REGISTRATION

The system can supervise the location of each D^{term} Drover and allow call termination after receiving the location registration request.

RADIO CHANNEL CHANGEOVER

Speech quality and interference are monitored. When the quality is poor or interference makes communication difficult, automatic changeover to another channel improves the speech quality and eliminates interference.

SPEECH ENCRYPTION

A call is protected from being tapped.

SPEED DIAL

The D^{term} Drover user can dial frequently called numbers using 2-digit abbreviated call codes.

VOICE MAIL INDICATION

When a message is mailed to the D^{term} Drover, the envelope icon is displayed on its LCD along with a short ring tone.

**SERVICE
CONDITIONS****Data Assignment**

- ④ PHS handsets can be assigned to receive internal calls with Voice or Tone signalling.
- ④ The PS handsets must be allocated extension numbers from the systems internal numbering plan.
- ④ Ringing line preference can be assigned to PS handset ports.
- ④ Function numbers 083 and 084 must be assigned to Access Codes (not set in default).
- ④ DIT/ANA can be assigned to PHS handsets.
- ④ The PS handsets must be allocated port numbers in blocks of 4. These form part of the systems total port capacity.
- ④ The tone presented to a caller when the PHS handset is out of the coverage area can be assigned as either Busy Tone or Ring Back Tone.
- ④ If the PHS phone is set with CFBNA and is turned off or Out of Area:
When MB1-2-30 = 00, call goes to the Personal VM Greeting Message after the MB1-2-22 timer.

When MB1-2-30 = XX sec, call goes to the Opening Greeting Message of VM after the 1-2-30 timer.

If the PHS phone is set with CFA, all calls go immediately to the Personal VM Greeting Message.

- ④ A maximum of four PS handsets should be programmed with the same Call Arrival Key (CAR). A maximum of four PS handsets within the same Call Area will ring simultaneously when receiving incoming outside calls on CAR keys.

General

- ④ Maximum allowable placement.

Equipment	Xen IPK Expanded		Xen IPK Basic	
	Maximum No.	Slot Allowed	Maximum No.	Slot Allowed
BSU(2)-U() ETU	8	Any slot in the 1st, 2nd or 3rd KSU, except ISA slot	8	Any slot in the 1st, 2nd or 3rd KSU, except ISA slot.
BS21 (AU)- ID/ND	16	NA	16	NA
PHS Terminals	40	NA	24	NA







- ④ Each base station provides 3 voice channels (3 simultaneous conversations). If a greater amount of simultaneous call traffic is expected in an area, increase the number of base stations in that zone to provide additional voice channels.
- ④ Each base station covers an area of approximately 100 meters in radius. This distance however, depends very much on the nature of the site, e.g.: the materials used in the construction of the building, the layout of the building, the height and location of the base station, etc.
- ④ A site survey should be performed before installation of the system to determine the optimum locations for the base stations. Base stations should be positioned so that a degree of overlap is provided in the coverage of each unit, ensuring reliable hand over of calls when moving between cells.
- ④ One base station in a system must be a BS21(AU)-ID unit (master). The remaining base stations must be BS21(AU)-ND units (slaves).
- ④ Data Communication is not supported with this system.



- Either a Line Key or Call Appearance Key (CAP key) must be programmed for each PS handset port to enable line seizure and to allow DIT, DID and transferred CO calls to be answered.

Table A6-1: Specifications for BS/PS

Cell Station		Personal Station	
Item	Specification	Item	Specification
No of voice channels per BS	Maximum 3	Frequency	1.895 ~ 1.918 GHz
KTS Interface	4-wire	Signal Power	10mW
Power Supply	AC 240V (local supply)	Voice coding/decoding system	32 KBPS ADPCM
Distance between KTS and BS	600m using 0.5mm diameter wire (AWG24)	Battery	Lithium
Dimensions	258(w) x 29(d) x 143(h)mm	Conversation Time	6 hours
Volume	800 cc	Standby Time	500 hours
Weight	630 g	LCD	2 line, 11 digit display (with scrolling)
		Dimensions	38(w) x 28(d) x 123(h) mm
		Volume	95 cc
		Weight	95 g

GUIDE TO FEATURE PROGRAMMING

Order and Shortcut	System Data Name	Memory Block	Function	1-8-07 Attendant Page-Line Key	1-8-08 Station Page-Line Key
 + BS	Card Interface Slot Assignment	7-1			
 + AP	PS Telephone Block Assignment	1-2-21			
 + BS	Station Number Assignment	4-10			
 + BTT	Station Name Assignment	4-18			
 + AP	PS Out of Area Time Assignment	1-2-30			
 + BTM	Ringing Line Preference Selection	4-11			
 + BTS	Class of Service (Station) Feature Selection 2	1-8-08			1-1, 2-5, 3-3, 3-8, 4-3, 4-4, 5-4, 5-7

Order and Shortcut	System Data Name	Memory Block	Function	1-8-07 Attendant Page-Line Key	1-8-08 Station Page-Line Key
 + BTT	Station to Class of Service Feature Assignment	4-17			
 + BTM	Ringing Line Preference Selection	4-11			

Music on Hold

M-7

FEATURE DESCRIPTION

A locally provided music source or an internal music source can be used to supply music to parties on hold, to assure them that they are still connected to the system.

CO ports can also be used to provide multiple music sources to different COs in the system.

SYSTEM AVAILABILITY

Terminal Type

Not applicable.

Required Components

External source connected to the RCA jack on the basic B64-U() KSU, or to a port of a COI()-U() or COID()-U() ETU.

OPERATING PROCEDURES

Not applicable.

SERVICE CONDITIONS

Data Assignment

- ④ Use Memory Block 4-66 (MOH or Ring Back Tone Selection) to assign MOH or Ring Back Tone for the outside party when a trunk call is placed on hold by the Transfer key on a D^{term} Series i, or hook flash from a Single Line Telephone, or the Transfer or Hold keys at a PHS station.
- ④ When Memory Block 3-11 (CO External Source Selection) contradicts Memory Block 3-12 (Trunk-to-MOH Trunk Assignment) MOH works according to the Memory Block 1-8-31 (Hold Tone Source Assignment) setting.
- ④ Use Memory Block 3-11 (CO External Source Selection) to specify whether the MOH source is from the CO (default) or an EXT SOURCE. Unused circuits on a COI/COID ETU can be assigned as MOH inputs.
- ④ Use Memory Block 3-12, (Trunk-to-MOH Trunk Assignment) to assign the external music source to each trunk.

Example:

Trunks 09 and 10 are assigned as external sources. Trunk 09 is programmed as the external source for Trunks 01~05 when a call is placed on hold. Trunk 10 is programmed as the external source for Trunks 06~08 when a call is placed on hold.

- ④ When connecting an external music source to a spare port of a COI()-U() ETU or COID()-U() ETU, a powered line isolation unit with a telecommunications compliance label is required to provide line voltage into the port. For example, Batesford Electronics Model No. TIC2F2.







General

- ④ Music On Hold (MOH) is provided for all outside and internal calls on hold.
- ④ Music On Hold can be disabled if required.
- ④ Music On Hold is provided using the built-in tone melodies or an external source connected to the RCA jack on the basic B64-U() KSU.
- ④ Internal Source:
 - Program one of two melodies (American Folk Song melody, or Christmas Song melody) as an internal source. A volume control for the built-in MOH source can also be programmed.
- ④ External Source:
 - Music source (radio, tape player, or CD) must be provided locally.
 - Source output levels should be less than 0.6 RMS signal level with 600 Ω impedance.
 - Optional interface ETUs are not required for this feature.
- ④ A CO line that is assigned as a CO external music on hold source cannot be seized, even when the CO trunk is assigned on a line key of a Multiline terminal.
- ④ A CO line that is assigned to a CO external music of hold source is skipped without being seized, even when that CO is assigned to a trunk group.

RELATED FEATURES LIST

Feature Number	Feature Name
A-8	Answer Hold
A-15	Attendant Transfer
A-24	Automatic Hold
H-5	Hold With Recall (Exclusive & Non- Exclusive)
S-18	Station Relocation

GUIDE TO FEATURE PROGRAMMING

Order and Shortcut	System Data Name	Memory Block	Function	1-8-07 Attendant Page-Line Key	1-8-08 Station Page-Line Key
 + AU	Automated Attendant Delay Announcement Hold Tone section	1-4-17			
 + BCS	Music on Hold Pattern Selection	1-8-09			
 + BCS	Hold Tone Source Assignment	1-8-31			
 + BCS	Hold Internal Tone Volume Selection	1-8-32			
 + BCT	CO External Source Selection	3-11			
 + BCT	CO External Hold Memory Selection	3-12			
 + BTT	MOH or Ring Back Tone Selection	4-66			

THIS PAGE INTENTIONALLY LEFT BLANK

Nesting Dial

N-1

FEATURE DESCRIPTION

Multiline Terminal users may store up to four Speed Dial (System or Station Speed Dial) buffer numbers in one Station Speed Dial buffer. All four buffers can then be consecutively dialed by pressing the Redial key and dialling a single Station Speed Dial buffer number.

SYSTEM AVAILABILITY

Terminal Type

All Multiline Terminals.

Required Components

None.

OPERATING PROCEDURES

To program Nesting Dial in a Speed Dial buffer:

1. Press **Feature**.
2. Press **Redial**.
3. Dial the Speed Dial buffer number to be programmed (**0 0** ~ **9 9** or **0 0 0** ~ **9 9 9**).
4. Dial the Trunk or Trunk Group Access Code (maximum 4 digits).
5. Press **Answer**.
6. Dial the Speed Dial buffer number to be nested (**0 0** ~ **9 9** or **0 0 0** ~ **9 9 9**).
7. Repeat steps 5 and 6 up to three times if required.
8. Press **Hold**, and enter a name using the Character Codes (optional step).
9. Press **Feature**.

To program Nesting Dial in the Feature Access key:





1. Press **Feature**.
2. Press **Redial**.
3. Press the Feature Access key.
4. Dial (Function) code **0**.
5. Dial the Trunk or Trunk Group Access Code (maximum four digits).
6. Press **Answer**.
7. Dial the Speed Dial buffer number to be nested (**0 0 ~ 9 9**).
8. Repeat steps 6 and 7 up to three times if required.
9. Press **Hold**, and enter a name using the Character Codes (optional step).
10. Press **Feature**.

To program Nesting Dial in a One-Touch key:

1. Press **Feature**.
2. Press **Redial**.
3. Press the One-Touch key.
4. Dial (Function) code **0**.
5. Dial the Trunk or Trunk Group Access Code (maximum four digits).
6. Press **Answer**.
7. Dial the Speed Dial buffer number to be nested (**0 0 ~ 9 9**).
8. Repeat steps 6 and 7 up to three times if required.
9. Press **Feature**.

To Use Nesting/Speed Dial from a Multiline Terminal:

Key Function





1. Press the desired CO/PBX line key.
2. Press .
3. Dial the Speed Dial buffer number (  ~  ) with nested buffer(s).
4. Use Handsfree Answerback or lift the handset, and talk with the called party.

- OR -

Press the desired CO/PBX line key.

5. Press the desired Feature Access key or One-Touch key.
6. Use Handsfree Answerback or lift the handset, and talk with the called party.

Multifunction (Dial Access)

1. Press .
2. Dial the Speed Dial buffer number (  ~  ) with nested buffer(s).
3. Use Handsfree Answerback or lift the handset, and talk with the called party.





- OR -

Press the desired Feature Access key or One-Touch key.

4. Use Handsfree Answerback or lift the handset, and talk with the called party.

To use Nesting/Speed Dial from a Single Line Telephone:

Multifunction (Dial Access) Only

1. Lift the handset and receive dial tone.
2. Dial Speed Dial Access Code  (set as default).
3. Dial the Speed Dial buffer number (  ~  ) with nested buffer(s).
4. Talk with called party.

SERVICE CONDITIONS

Restrictions

- ④ A maximum of 24 digits can be programmed into a Speed Dial buffer.
- ④ A maximum of 22 digits can be programmed into a Feature Access key.
- ④ A maximum of 16 digits can be programmed into a One-Touch key.

General

- ④ Each nested buffer reduces the amount of digits allowed in a Speed Dial buffer by three.
- ④ System and Station Speed Dial buffers can be nested into a Station Speed Dial buffer.
- ④ Station Speed Dial buffers cannot be nested into a System Speed Dial buffer.
- ④ Up to four System Speed Dial buffers can be nested into one System or Station Speed Dial buffer.
- ④ A Speed Dial buffer, with nested number(s), cannot be nested into another Speed Dial buffer.
- ④ Nesting Dial is allowed under Feature Access keys and One-Touch keys.
- ④ Single Line Telephones cannot be used to program Nesting Dial into their Station Speed Dial buffers.

RELATED FEATURES LIST

Feature Number	Feature Name
F-1	Feature Access – User Programmable
S-10	Speed Dial – Station
S-12	Speed Dial – System

Night Call Pickup

N-2

FEATURE DESCRIPTION

The Night Call Pickup feature functions when the system is in Night Mode and an incoming call rings in. When the Night Chime is ringing, station users are able to answer incoming calls by dialling the Night Call Pickup Access Code or by pressing a Feature Access key programmed for Night Call Pickup.

SYSTEM AVAILABILITY

Terminal Type



All terminals.

Required Components

ECR-U() ETU

OPERATING PROCEDURES

For a Night Mode incoming outside call (Night Chime Ringing):



1. Lift the handset; receive internal dial tone.
2. Dial the Night Call Pickup Access Code   (set as default).
- OR -
Press the Feature Access key programmed for Night Call Pickup.
3. Connection to incoming call is completed.
 -  Default Access Codes can be changed in System Programming during installation.

SERVICE CONDITIONS

Data Assignment

-  The Night Call Pickup Access Code can be assigned in System Programming.

Restrictions

-  Tie/DID incoming calls cannot be answered via Night Call Pickup unless Tie/DID Delay Ringing is assigned in System Programming and Delay Ringing has started.
-  DIT/ANA calls cannot be answered via Night Call Pickup.



General

- ④ The Night Call Pickup Access Code is valid when any tenant is in the Night Mode and the Night Chime Feature has been assigned for that tenant in System Programming.
- ④ When several incoming calls are ringing in at the same time, the lowest numbered line is answered first.

RELATED FEATURES LIST

Feature Number	Feature Name
N-3	Night Chime
N-4	Night Transfer

GUIDE TO FEATURE PROGRAMMING

Order and Shortcut	System Data Name	Memory Block	Function	1-8-07 Attendant Page-Line Key	1-8-08 Station Page-Line Key
 +BS	Card Interface Slot Assignment	7-1			
 +BN	ECR Relay to Tenant Assignment	2-08			
 +BA	Access Code (1-, 2-, or 3-Digit) Assignment	1-1-46/47/ 48	058		

Night Chime

N-3

FEATURE DESCRIPTION

The Night Chime feature provides a common audible tone signal with one relay contact for control when incoming CO/PBX calls are received in Night Mode. The relay contact closures may also be used for external bells or chimes. The Night Chime feature is used after working hours to alert night personnel of incoming outside calls.

SYSTEM AVAILABILITY

Terminal Type

Not applicable.

Required Components

ECR-U() ETU for common audible tone and control relay.

OPERATING PROCEDURES

Not applicable.

SERVICE CONDITIONS

Restrictions

- ☎ Tie/DID lines, DIT/ANA calls, and Automated Attendant do not activate the Night Chime relay.



General

- ☎ An ECR-U() ETU is required for common audible tone and control relays. Ten relays are provided with this ETU. One relay is provided for Night Chime control.
- ☎ The Night Chime control relay is activated based on Night Mode of each Tenant group.
- ☎ Ringing interval for Night Chime is fixed (1 sec. ON/1 sec. OFF).
- ☎ The ECR-U() ETU provides a common audible tone source for Night Chime ringing and External Tone ringing.
- ☎ The Night Chime equipment must be provided locally.
- ☎ From a station in the same Tenant group, the Call Pickup Tenant Access Code can be used.
- ☎ If a trunk is not assigned to a Tenant group, the Night Chime feature does not work.

RELATED FEATURES LIST

Feature Number	Feature Name
N-2	Night Call Pickup
N-4	Night Transfer

GUIDE TO FEATURE PROGRAMMING

Order and Shortcut	System Data Name	Memory Block	Function	1-8-07 Attendant Page-Line Key	1-8-08 Station Page-Line Key
 +BS	Card Interface Slot Assignment	7-1			
 +BP	External Ring Relay Cycle Selection	1-7-07			
 +BN	* ECR Relay to Tenant Assignment	2-08			

* When the system is at default this Memory Block **must** be programmed for the feature to be used.

Night Transfer

N-4

FEATURE DESCRIPTION

Attendant Positions (with or without Attendant Add-On Consoles) can place the system in or out of Night Mode. This provides a change in the ring assignment of CO/PBX lines, activates ANA Assignments, Night Call Pickup, Night Chime, Code Restriction Class Assignments, and Automated Attendant messages. This feature can operate system-wide or per tenant.

SYSTEM AVAILABILITY

Terminal Type

Attendant Positions assigned this ability.

Required Components

None.

OPERATING PROCEDURES

To set for Night Transfer system-wide:

1. Press **Feature**.
2. Dial Access Code **8** **0**.
3. Press **Feature**.

- OR -

Press the Night Transfer key on the Attendant Add-On Console during Day Mode.

To cancel Night Transfer system-wide:

1. Press **Feature**.
2. Dial Access Code **8** **0**.
3. Press **Feature**.

- OR -

Press the Night Transfer (NT) key on the Attendant Add-On Console during Night Mode.

To set per tenant:

1. Press **Feature**.
2. Dial Access Code **8** **5**.
3. Enter the Tenant number (**0** **0** ~ **4** **7**).
4. Press **Feature**.

To cancel per tenant:

1. Press **Feature**.
2. Dial Access Code **8** **5**.
3. Enter the tenant number (**0** **0** ~ **4** **7**).
4. Press **Feature**.

**SERVICE
CONDITIONS****Data Assignment**

- ☎ The ability to set/reset Night Transfer is allowed or denied in Attendant Class of Service selection.
- ☎ The system can be programmed to automatically switch to the Night Mode (system-wide) at a specified time.

General

- ☎ The following features are be affected when switching to the Night Mode.
 - Flexible Ringing Assignment
 - ANA Assignment
 - Code Restriction Class Assignment
 - Automated Attendant
 - Night Chime
 - Night Call Pickup
- ☎ Feature Access keys or One-Touch keys can be assigned to set/cancel Night Transfer (system-wide or per tenant).

**RELATED
FEATURES LIST**

Feature Number	Feature Name
C-17	Class of Service

GUIDE TO FEATURE PROGRAMMING

Order and Shortcut	System Data Name	Memory Block	Function	1-8-07 Attendant Page-Line Key	1-8-08 Station Page-Line Key
 +BTS	Class of Service (Attendant) Feature Selection 1	1-8-07		1-1, 1-2,	
 +BTT	Station to Class of Service Feature Assignment	4-17			
 +BTT	Telephone to Tenant Assignment	4-09			
 +BTM	Line Key Selection for Telephone Mode	4-12			
 +BTT	CO/PBX Ring Assignment (Day Mode)	4-01			
 +BTT	CO/PBX Ring Assignment (Night Mode)	4-02			
 +BTM	Extension Line Key Ring Assignment (Day Mode)	4-37			
 +BTM	Extension Line Key Ring Assignment (Night Mode)	4-38			
 +BN	Trunk to Tenant Assignment	2-01			
 +BTD	Attendant Add-On Console Key Selection	1-6-05			
 +BCT	Trunk-to-Trunk Group Assignment	3-03			
 +BCT	DIT Assignment	3-42			
 +BCT	ANA Assignment	3-43			
 +AC	Code Restriction Class Assignment (Day Mode)	4-07			
 +AC	Code Restriction Class Assignment (Night Mode)	4-08			
 +BM	Automatic Day/Night Mode Switching Time Slot	1-1-27			
 +BM	Automatic Day/Night Mode by Day of Week Selection	1-1-32			

THIS PAGE INTENTIONALLY LEFT BLANK

Off-Hook Ringing

O-1

FEATURE DESCRIPTION

The Off-Hook Ringing feature alerts a Multiline Terminal user that an incoming outside call is ringing to that station while the user is engaged on another call. Off-Hook Ringing is provided through the built-in speaker of the Multiline Terminal and at a lower volume than On-Hook Ringing.

SYSTEM AVAILABILITY

Terminal Type

All Multiline Terminals.

Required Components

None.

OPERATING PROCEDURES

To set off-hook ringing volume:

1. Go off-hook with the handset.
2. Dial the Access Code (default $\text{MNO } 0$).
3. Dial T from the dial pad.
4. Press ^ (\wedge = increase) or v (= decrease) to increase/decrease off-hook ringing volume.
5. Go on-hook.

SERVICE CONDITIONS

Data Assignment

- Off-Hook Ringing is assigned per station (default All stations have Off-Hook Ringing).

Restrictions

- Off-Hook Ringing is not provided when the Multiline Terminal speaker is activated or when the terminal is in Do Not Disturb (DND) mode.



General

- Off-Hook Ringing applies only to lines assigned to ring.
- At system default, Off-Hook Ringing tone volume is approximately 10 dB lower than On-Hook Ringing tone volume.
- The Off-Hook Ringing feature is effective when a headset is used.
- Off-Hook Ringing follows the Distinctive Ringing Pattern selection and not Synchronous Ringing.
- Off-Hook Ringing is provided for calls to a Secondary Incoming Extension when the station user is busy on an internal or outside call.

RELATED FEATURES LIST

Feature Number	Feature Name
D-14	Do Not Disturb (DND)

GUIDE TO FEATURE PROGRAMMING

Order and Shortcut	System Data Name	Memory Block	Function	1-8-07 Attendant Page-Line Key	1-8-08 Station Page-Line Key
 +BA	Access Code (1-, 2-, 3-Digit) Assignment	1-1-46/47/48	049		
 +BTS	Off-Hook Ringing Selection	4-51			

* When the system is at default this Memory Block **must** be programmed for the feature to be used.

Off-Premise Extension

O-2

FEATURE DESCRIPTION

This feature allows Single Line Telephones (SLTs) located remotely, up to 6km away, to access the Xen IPK System with the same ability as an on-site Single Line Telephone.

SYSTEM AVAILABILITY

Terminal Type

Single Line Telephones.

Required components

OPX(2)-U() ETU

OPERATING PROCEDURES

Normal programming assignments and call handling procedures apply:

SERVICE CONDITIONS

Restrictions

- ⓘ The OPX(2)-U() ETU Unit does not support a connection to a Voice Mail Unit at the remote site.

General

- ⓘ Each OPX(2)-U() ETU Unit provides two circuits.
- ⓘ The maximum loop resistance between an OPX(2)-U() ETU and an Off-Premise Extension Single Line Telephone is 1800 ohms (including Single Line Telephone set resistance).
- ⓘ The OPX(2)-U() ETU Unit has a built-in ringer (RSG). This ETU supports Synchronous Ringing and detects Dial Pulse/DTMF tones.
- ⓘ In system programming, the OPX(2)-U() ETU is considered to be the same as an SLI(4)-U() Unit.
- ⓘ Maximum of 6 OPX(2)-U() ETUs are supported in an Xen IPK Basic System.
- ⓘ Maximum of 22 OPX(2)-U() ETUs are supported in a Xen IPK Expanded System.

**GUIDE TO
FEATURE
PROGRAMMING**

Order and Shortcut	System Data Name	Memory Block	Function	1-8-07 Attendant Page- Line Key	1-8-08 Station Page- Line Key
 +BS	Card Interface Slot Assignment	7-1			

THIS PAGE INTENTIONALLY LEFT BLANK

One-Touch/Feature Access Key

0-3

FEATURE DESCRIPTION

One-Touch/Feature Access Keys are provided with Multiline Terminals to allow a Multiline Terminal user to press a single, flexible Feature Access key or One-Touch key to access many system features, System/Station Speed Dial or Direct Station Selection without going off-hook first.

SYSTEM AVAILABILITY

Terminal Type

All Multiline Terminals.

Required Components

None.

OPERATING PROCEDURES

Refer to Related Features for the Operating Procedures:

SERVICE CONDITIONS

Restrictions

- Feature Access keys and One-Touch keys are similar in purpose and capability. Up to 16 feature access keys are available depending on system programming and available Line keys. One-Touch key availability is controlled by the type of Multiline Terminal.

General

- You can press a single key to call a station, access a Speed Dial buffer, or activate a feature.
- When the MIC key is programmed on a One-Touch or Feature Access Key, set/cancel is operated by toggle.
- Trunk access can be programmed on a Feature Access or One-Touch key.
- The following quantities of Feature Access Keys and One-Touch Keys are available on each Multiline Terminal. BLF LED indication is provided on each key, each for the One-Touch Keys of the ETW-24S-1A (SW) TEL. The number of Feature Access Keys available depends on the number of Line Keys and Single On/Off Keys assigned in System Programming.

Terminal Type	Feature Access Key	One-Touch Key
DTR/DTU-8D-1A() TEL	8	0
DTR/DTU-16D-1A() TEL	16	0
DTR/DTU-32D-1A() TEL	16	16/8
DTR/DTP-2DT-1A() TEL	2	0

- ④ When programming Feature Access or One-Touch keys, the Conf key can be used to backspace and erase an entry.
- ④ Each One-Touch key can store up to 16 digits.
- ④ Nesting Dial is allowed under One-Touch keys.
- ④ When programming Feature Access or One-Touch keys, the following feature keys can be entered and stored by first pressing the Answer key, then pressing Recall, Feature, Conf, Redial, Speaker, Answer, Transfer, or Hold.

RELATED FEATURES LIST

Feature Number	Feature Name
F-1	Feature Access – User Programmable
N-1	Nesting Dial
S-11	Speed Dial Stored Characters
S-10	Speed Dial – Station

PC Attendant Console

P-1

FEATURE DESCRIPTION

The XenMail PC Attendant is a powerful Windows application that integrates the major features of the traditional attendant position with the power of a PC to form a robust database-driven application that increases productivity and provides efficient, accurate call processing that is required in today's service oriented market.

PC Attendant runs on a the PC and communicates with the Xen IPK system through a normal digital station port using the CT(A)-U() or CT(U)-U() Unit that is installed in the Multiline Terminal.

When calls come in to this station, PC Attendant displays the call information on the PC and provides several options for handling calls quickly and effectively. PC Attendant can be minimised to run in the background and pop to the front when call activity occurs allowing the user to handle the call either with the keyboard or mouse. PC Attendant users can speak either through a headset or the Multiline Telephone.

SYSTEM AVAILABILITY

Terminal Type

Multiline Terminals

Required Components

Pentium 166 or higher with a minimum of 32 MB RAM and a minimum of 15 MB of free hard disk space.

Windows 95 or later.

CD ROM Drive.

MAPI compliant e-mail application (required if using the e-mail features of PC Attendant).

Printer (required if using the printing features of the PC Attendant).

CT(A0-U() or CT(U)-U() Unit installed in a Multiline Terminal.

OPERATING PROCEDURES

Refer to the XenMail PC Attendant Installation Manual.

SERVICE CONDITIONS

- ④ PC Attendant has three main components:
 1. *PC Attendant Application Software*: This application runs on a PC and provides the PC based GUI (Graphical User Interface) and features.
 2. *TAPI Adapter*: The CT(A) or CT(U) Adapter is installed in a Multiline Terminal and connects to a digital station line of the Xen IPK. PC Attendant communicates to the Xen IPK system through the TAPI Adapter.
 3. *Headset*: The headset can be plugged into the Multiline Terminal and is used when making and receiving calls through PC Attendant.

When the KTS is configured to support Caller ID indication, PC Attendant displays the caller ID information on all incoming calls.

If Caller ID is available and the KTS is set up as a square system (i.e. Line Key 1 = CO1, Line Key 2 = CO2, ...), Caller IDs for multiple CO calls coming into the PC Attendant simultaneously may swap on the PC call window indication for those calls. For this reason, NEC does not recommend using caller ID with this product unless the station is set up with CAP keys (Call Appearance Keys). When CAP keys are assigned, Caller ID works properly. Refer to the Xen IPK System Programming Manual for details on CAP key setup.

- ④ PC Attendant can monitor a maximum of 30 DSS/BLF buttons.
- ④ An unlimited number of stations can be entered into the database. Each station record can contain information such as the station user name, address, extension number, e-mail address, pager, other telephone numbers (i.e. cellular, pager, home). Each station record can also show the MONITOR status of that telephone (BUSY, IDLE, or DND). Special notes can also be entered for each station. These notes can provide more details about the station user such as availability, schedule, meetings, and more.
- ④ Intelligent Configuration Wizard: the Configuration Wizard guides users through the setup procedure making installation easy. Answer the Wizard questions, such as "How many DSS keys?", and the Wizard auto-programs the DSS/BLF buttons.
- ④ The Wizard automatically programs up to 20 DSS/BLF buttons based on connected telephone types. Other DSS/BLF buttons must be manually programmed as Feature keys.

- PC Attendant supports a maximum of 24 lines. However, each additional DSS/BLF programmed beyond the value in the Maximum Number of DSS/BLF Buttons Wizard Auto-Programs column, reduces the maximum number of 24 lines by one. Line refers to CO lines, Secondary Incoming Extension (SIE), Call Arrival Keys (CAR keys), or Call Appearance Keys (CAP Keys).

Connected Telephone Type	Maximum Number of DSS/BLF Buttons Wizard Auto-Programs	Maximum DSS/BLFs XenMail Monitors
NONE	20	30
DTU-32D	16	26
DTU-16D	0	10
DTR-16D	20	30

- Multiline Functionality: PC Attendant can handle multiple incoming and outgoing calls and maintain and display the status of each.
- Call Log Capture tracks all incoming and outgoing calls received and made by an attendant displaying the caller ID and duration of each call.
- Unlimited personal speed dial buttons can be added on the user interface.
- PC Attendant provides major attendant functions such as NIGHT MODE set, ZONE PAGING, QUICK TRF to VM, and more. With the Flexible Smart Panel controls, feature buttons are displayed based on the appropriate call state. Buttons can be added or deleted to suit the user needs.
- Live Record to WAV File with E-Mail Option: if someone leaves a message that is too long and fast to type, click the record button and save the conversation to the hard disk on the PC as a WAV file. The sound recorded message can then be e-mailed to the intended recipient.

Note: Recording telephone conversations may be illegal under certain circumstances and laws; consult a legal advisor before recording a telephone conversation. Some federal and state laws require the party recording a telephone conversation to use an alert tone to notify all parties to the telephone conversation. Some of these laws provide strict penalties for illegal recording of telephone conversations.

- To e-mail the message, a MAPI compliant e-mail application is required.

- ④ **Message Pad with E-Mail Option**
Click the TAKE MSG button and a message pad pops up with the name or number of the caller and date and time already filled in. Enter the message and either print it or e-mail it to the intended recipient.
- ④ **Auto Greeting Player**
A different prerecorded WAV file for each line can be set up. When a call is answered, PC Attendant automatically plays the prerecorded WAV file to the calling party.
- ④ **Remember Last Transfer**
PC Attendant remembers who called and for whom they called. If John Smith calls PC Attendant and asks to be transferred to Mary Smith, the next time John Smith calls, PC Attendant defaults the transfer destination to her extension.

FEATURE DESCRIPTION

The MIFM-U() ETU and Maintenance Access Terminal (MAT) software allows the system to be programmed from a personal computer (PC). System Data can be transferred to/from a diskette for backup of system data. MAT PC programming software also allows the user to print station designation strips to shorten installation time. End users can use the Customer Administration Terminal (CAT) PC programming software to program several features for their Multiline Terminals such as: Line Key Assignment, Telephone Names, Zone Paging Groups, or various timers.

SYSTEM AVAILABILITY

Terminal Type

Not applicable.

Required Components

MIFM-U() ETU

Pentium PC with Windows 95 or higher to run MAT PC programming

OPERATING PROCEDURES

Refer to the Xen IPK System Programming Manual for PC programming instructions.









SERVICE CONDITIONS

- ④ The MIFM-U() ETU provides the RS-232C connector for connection of a PC or a modem
- ④ PC Specifications:
 - Pentium PC
 - Windows 95 or higher
 - At least 13MB of free hard disk space
 - Unused PC serial communications port
 - MNP Class 4 or V.42 bis modem (if remote programming is required).

RELATED FEATURES LIST

Feature Number	Feature Name
R-4	Remote Programming

GUIDE TO FEATURE PROGRAMMING

Order and Shortcut	System Data Name	Memory Block	Function	1-8-07 Attendant Page-Line Key	1-8-08 Station Page-Line Key
 +BS	Card Interface Slot Assignment	7-1			
 +BS	MIF (SMDR) Assignment	7-3-02			
 +BS	MIF (LCR) Assignment	7-3-01			
 +CSS	COM Port Parity/Stop Bit Setting Assignment	1-8-36			
 +CSS	COM Port Baud Rate Setting Assignment	1-8-35			
 +CSS	Modem Port for Remote Programming Assignment	1-8-38			
 +CSN	Site Name Assignment	1-8-18			
 +CSP	PC Programming Password Assignment	1-8-17			

Pooled Line (Outgoing)

P-3

FEATURE DESCRIPTION

The Pooled Line feature allows Multiline Terminal users to seize an outside line on one Pooled line key. One Pooled line key can accommodate a Trunk group or Route Advance Block.

SYSTEM AVAILABILITY

Terminal Type

All Multiline Terminals.

Required Components

None.

OPERATING PROCEDURES

To originate an outside call:

1. Press the Pooled line key, and receive outside line dial tone.
2. Dial the desired telephone number.

SERVICE CONDITIONS

Data Assignment

- ⓘ A Pooled Line (Outgoing) can be programmed to appear at a station using line key assignment in System Programming.





Restrictions

- ⓘ A Pooled Line (Outgoing) cannot receive incoming calls.

General

- ⓘ A maximum of 48 pooled groups are allowed per system. Each pooled group corresponds to a Trunk Group number (1~32) or a Route Advance Block number (1~32).
- ⓘ Pooled Line LED indicates the status of the pooled group as follows:
On: All trunks belonging to the pooled group are in use.
Off: Some or all trunks belonging to the pooled group are idle.
- ⓘ When an idle Pooled line key is pressed, an idle trunk belonging to that pooled group is automatically selected. If the Xen IPK system is designated as KF registration, this feature is not available.
- ⓘ A user on a Pooled Line can access Call Park - System, Call Transfer, and Conference.
- ⓘ Trunk Queuing can be set when the Pooled line key is in a busy status (red LED).
- ⓘ When a trunk is selected from Pooled line key, it appears on a CO line key or on a Call Appearance key (CAP) on the Multiline Terminal.

GUIDE TO FEATURE PROGRAMMING

Order and Shortcut	System Data Name	Memory Block	Function	1-8-07 Attendant Page-Line Key	1-8-08 Station Page-Line Key
 +BCT	Trunk-to-Trunk Group Assignment	3-03			
 +BTM	* Line Key Selection for Telephone Mode	4-12			
 +BN	Line Key Selection	2-05			
 +BN	Line Key Selection for Tenant Mode	2-06			

* When the system is at default this Memory Block **must** be programmed for the feature to be used.

Power Failure Transfer

P-4

FEATURE DESCRIPTION

The Power Failure Transfer feature ensures that a customer has access to the Central Office network during a power outage. The CO/PBX tip and ring are automatically transferred to the tip and ring of a preselected Single Line Telephone. The Single Line Telephone can function in the system during normal operation or can be only be used during a power failure. Each B64-U() KSU provide three circuits for this feature.

SYSTEM AVAILABILITY

Terminal Type

Single Line Telephones.

Required Components

None.

OPERATING PROCEDURES

A CO/PBX line is automatically switched to locally provided Single Line Telephone when total system power is lost, and system battery backup expires.

SERVICE CONDITIONS

General

- ④ The Single Line Telephones that are installed must provide dialling signals accepted by the outside exchange (Dial Pulse or Dual-Tone Multifrequency).
- ④ Only Single Line Telephones cross-connected at the MDF can be used for this feature.
- ④ Single Line Telephones and outside lines connected during power failure are fixed one-to-one.
- ④ System features cannot be activated from Single Line Telephones when Power Failure Transfer is in operation.
- ④ When power is restored to the system, Power Failure Transfer is cancelled. Calls in progress on Power Failure Transfer lines are disconnected.

**GUIDE TO
FEATURE
PROGRAMMING**

Order and Shortcut	System Data Name	Memory Block	Function	1-8-07 Attendant Page-Line Key	1-8-08 Station Page-Line Key
 +BS	Card Interface Slot Assignment	7-1			

FEATURE DESCRIPTION

The Preset Dialling feature enables a Multiline Terminal user to originate an outgoing call by predialling digits on the keypad. After dialling the number, the user can go off-hook, press the Speaker key, or press a line key to make the call.

SYSTEM AVAILABILITY

Terminal Type

Any Multiline Terminal.

Required Components

None.

OPERATING PROCEDURES

To use this feature from a Multiline Terminal:

1. Dial the telephone number using the keypad.
2. Go off-hook, or press  (if prime line set for outside line), or press CO line key.

SERVICE CONDITIONS



Data Assignment

- ⓘ This feature is assigned in the class of service assignment.
- ⓘ Caller ID/Preset dial outgoing CO Selection must be assigned.

General

- ⓘ No confirmation tone is heard while dialling.
- ⓘ When a digit is not dialled within 10 seconds, this feature is automatically cancelled.
- ⓘ Pauses cannot be entered while dialling.
- ⓘ A maximum of 24 digits can be displayed.
- ⓘ A call originating using this feature is cancelled when the Redial key, Hold key, Transfer key or Recall key is pressed.
- ⓘ The Least Cost Routing feature (LCR) is in effect when using Preset Dialling.

GUIDE TO FEATURE PROGRAMMING

Order and Shortcut	System Data Name	Memory Block	Function	1-8-07 Attendant Page-Line Key	1-8-08 Station Page-Line Key
 +BTS	* Class of Service (Station) Feature Selection 2	1-8-08			5-5
 +AI	Caller ID Preset Dial Outgoing CO Selection	4-44			

* When the system is at default this Memory Block **must** be programmed for the feature to be used.

Prime Line Assignment

P-6

FEATURE DESCRIPTION

Prime Line Assignment allows a station user to go off-hook and originate an outside call from the trunk assigned as the Prime Line without pressing the line key. This feature allows access to a trunk, Trunk group, or Route Advance Block.

SYSTEM AVAILABILITY

Terminal Type

All terminals.

Required Components





None.

OPERATING PROCEDURES



To originate a call:

1. Lift the handset or press . Prime Line (outside line) is seized.
2. Proceed with the call.

To access an internal dial tone for Feature Access or an internal call from Multiline Terminals:

1. Lift the handset or press . Prime Line (outside line) is seized.
2. Press .
3. Dial Access Code   .
4. Dial the desired Feature Access Code or station number.

- OR -

Press  and .

To access an internal dial tone for Feature Access or an internal call from Single Line Telephones:

1. Lift the handset.
2. Press the hookswitch.
3. Dial the desired Feature Access Code or station number.

SERVICE CONDITIONS

Data Assignment

- ④ Prime Line can be assigned to a Trunk or a Pooled Line (Trunk Group or Route Advance Block) in system programming. There are two ways to achieve this, with MB 4-23 or MB 4-05. Refer programming manual for details.
- ④ Prime Line is assigned per station.

Restrictions

- ④ If Prime Line is busy or on Hold, a busy tone is received when going off-hook. (Another line must be seized manually.)

General

- ④ Ringing Line Preference takes priority over Prime Line when both features are assigned.
- ④ Internal Dial Tone Access Codes can be stored on a Feature Access or One-Touch key.
- ④ An internal line can be seized by pressing the ICM key (if assigned) before going off-hook.
- ④ Prime Line can be assigned to a Single Line Telephone.
- ④ If a Single Line Telephone user provides a hookflash, the outside line is put on hold and internal dial tone is heard. To return to the outside line, provide another hookflash.
- ④ The Service Conditions for Multiline Terminals when the Feature key and Access Code 6* are used to access intercom dial tone include:
 - The seized outside line is disconnected and internal dial tone is heard.
 - During an internal call or when receiving call waiting tone, busy tone, or reorder tone, pressing the Feature key and 6* again provides new internal dial tone.
 - If an incoming internal or ring transfer call is being received while off-hook and an outside dial tone is received, pressing the Feature key and 6* answers the call.
- ④ When using MB 4-05 trunks other than assigned trunk group (MB 2-01) can be accessed.

Privacy on All Calls

P-7

FEATURE DESCRIPTION

The system provides complete Privacy on All Calls. A station user cannot enter another conversation unless allowed via Barge-In or Add-On Conference.

SYSTEM AVAILABILITY

Terminal Type

All terminals.

Required Components

None.

OPERATING PROCEDURES

Not applicable.

SERVICE CONDITIONS

Data Assignment

- Use Memory Block 1-8-08 [Class of Service (Station) Feature Selection 2] Page 1 LK5 to Allow (default: LED On) or Deny (LED Off) Barge-In Receive.
- Use Memory Block 1-8-08 [Class of Service (Station) Feature Selection 2] Page 1 LK4 to Allow (LED On) or Deny (default: LED Off) Barge-In originate.

General

- Only the person talking may allow a third or fourth party to enter the conversation using Add-On Conference, unless the Barge-In feature is allowed at designated stations.
- All stations have privacy at default.

RELATED FEATURES LIST

Feature Number	Feature Name
A-4	Add-On Conference
B-3	Barge-In
C-17	Class of Service

GUIDE TO FEATURE PROGRAMMING

Order and Shortcut	System Data Name	Memory Block	Function	1-8-07 Attendant Page-Line Key	1-8-08 Station Page-Line Key
 +BTS	Class of Service (Station) Feature Selection 2	1-8-08			1-4, 1-5

* When the system is at default this Memory Block **must** be programmed for the feature to be used.

FEATURE DESCRIPTION

Privacy Release allows the multiline terminal user to release the privacy on an outside line by pressing a privacy release key programmed on the station. Another user can then press the same CO/PBX or CAP key to join the conversation in progress.

SYSTEM AVAILABILITY

Terminal Type
Multiline Terminals.

Required components
None.

OPERATING PROCEDURES

To program a Feature Access Key for Privacy Release from a Multiline Terminal:

1. Press **Feature** .
2. Press **Redial** .
3. Press the Feature Access Key.
4. Dial **2** .
ABC
5. Dial 10.
6. Press **Feature** .

Note: A Privacy Release Key must be assigned on the Multiline Terminal with the CO/PBX call before use

To program a One-Touch Key for Privacy Release from a Multiline Terminal:

1. Press **Feature** .
2. Press **Redial** .
3. Press the One-Touch Key.
4. Dial **2** .
ABC
5. Dial 10.
6. Press **Feature** .

To activate Privacy Release from a Multiline Terminal with a CO/PBX call in progress:

1. Lift the handset or press .
2. Press the CO/PBX Line key or CAP key that released privacy.

To Enter a Conversation using the Privacy Release from a Multiline Terminal:

1. Press the flashing line key or dial trunk access code for the trunk.

SERVICE CONDITIONS

Data Assignment

- ④ Use Memory Block 2-05 (Line Key Selection) to assign Tenant-Wide or Telephone (default) Mode for each Tenant.
- ④ Use Memory Block 2-06 (Line Key Selection for Tenant Mode) to assign CO/PBX trunks to the applicable Tenant
- ④ Use Memory Block 4-12 (Line Key Selection for Telephone Mode) to assign Feature Access Key (Page 1 LK6).

Restrictions

- ④ Privacy Release is only available on an Outside line.
- ④ Only two additional stations can be added per CO/PBX call after Privacy Release. After two parties have joined the conversation, the Conf key LED at all stations that did not enter is turned off. A third station that tries to enter receives a busy signal.
- ④ If the originating caller abandons the call, the user cannot enter the call again.
- ④ If there internal stations are connected to the CO/PBX, Privacy Release cannot be activated again until both added stations release the CO/PBX line.
- ④ A maximum of 16 Privacy Release calls are available.
- ④ Voice Over is prohibited to a station that has activated Privacy Release.
- ④ When a station is receiving Voice Over, activating Privacy Release is ignored and Voice Over continues.
- ④ Privacy Release and Live Record are not allowed at the same time.
- ④ Privacy Release cannot be used on Single Line Telephones.
- ④ Setting one feature will automatically cancel the other.
- ④ Specified CO/PBX seizure cannot be used to activate Privacy Release.

- ☎ Privacy Release is not allowed if a conference is in progress.
- ☎ To join a CO/PBX call using Privacy Release the originating CO/PBX key or CAP key must be assigned to that station.
- ☎ When only one station has entered via Privacy Release and feature deactivated, then the feature cannot be activated again until the joined station disconnects from conference.





General

- ☎ Privacy Release can be activated or deactivated while a CO/PBX call is in progress.
- ☎ The red Conf LED flashes during Privacy Release. After Privacy Release is cancelled or all allowed parties have joined, the LED is off
- ☎ The Conf key LED indication for Privacy Release is the same as the indication for a conference call.
- ☎ When Privacy Release is activated, the Conf key LED winks on all Multiline Terminals assigned to the same Tenant as the CO line with Privacy Release, even if the CO line is assigned to multiple Tenants.
- ☎ If the Conf key is pressed from the same station that activated Privacy Release, the Privacy Release feature is cancelled.
- ☎ Holding an internal call has priority over Privacy Release.
- ☎ When a CO assigned as a private line is Privacy Released, the Conf key at the shared private line flashes.

RELATED FEATURES LIST

Feature Number	Feature Name
A-4	Add-On Conference
B-3	Barge-In
C-17	Class of Service

GUIDE TO FEATURE PROGRAMMING

Order and Shortcut	System Data Name	Memory Block	Function	1-8-07 Attendant Page-Line Key	1-8-08 Station Page-Line Key
 +BN	Trunk to Tenant Assignment	2-01			
 +BN	Line Key Selection	2-05			
 +BTT	Telephone to Tenant Assignment	4-09			
 +BN	Line Key Selection for Tenant Mode	2-06			
 +BTM	Line Key Selection for Telephone Mode	4-12			

 One-Touch and Feature Access keys are programmable through SAT but not using system programming.

FEATURE DESCRIPTION

The Private Lines feature allows two outside lines to be programmed as private lines. Only a Multiline Terminal that has been programmed for the Private Lines feature can have access to these private lines. The LED status indication for the Private Lines does not appear on any other Multiline Terminal.

SYSTEM AVAILABILITY

Terminal Type

All terminals.

Required Components

None.

OPERATING PROCEDURES

Not applicable.

SERVICE CONDITIONS

Data Assignment

- ④ Two Private Lines can be specified in System Programming.
- ④ Private Lines can be assigned to Single Line Telephones, but Trunk Seizure depends on Specified Line Seizure assignments in System Programming.

Restrictions

- ④ Last Number Redial does not access a Private Line.

General



- ④ The following combinations are possible:
 1. Two stations with their own Private Line.
 2. Two stations sharing one Private Line.
 3. One station with two Private Lines.
- ④ Barge-In on a Private Line is possible only if the same Private Line is shared by two terminals.
- ④ Private Lines cannot be included in a conference and/or transferred except when two stations share a Private Line.
- ④ Private Lines cannot be accessed by a Trunk Access Code.

- ④ Tie lines can be assigned as Private Lines.
- ④ Private Lines cannot follow Call Forward assignments unless the destination telephones use the same Private Lines.

RELATED FEATURES LIST

Feature Number	Feature Name
B-3	Barge-In

GUIDE TO FEATURE PROGRAMMING

Order and Shortcut	System Data Name	Memory Block	Function	1-8-07 Attendant Page-Line Key	1-8-08 Station Page-Line Key
 +BA	Access Code (1-, 2-, 3-Digit) Assignment	1-1-46/47/48	050,051		
 +BCS	* Private Line Assignment	1-1-29			

* When the system is at default this Memory Block **must** be programmed for the feature to be used.

Programming from Multiline Terminal

P-10

FEATURE DESCRIPTION

System Programming can be performed from designated Multiline Terminals (with an LCD) connected to the first two ESIB(8)-U() ETU ports. Some programming changes can be entered while the system is operating, other programming changes occur when the affected telephones and circuits are idle.

SYSTEM AVAILABILITY

Terminal Type

Multiline Terminals (with LCD).

Required Components

ESIB(8)-U() or ESIE(8)-U() ETU



OPERATING PROCEDURES

Refer to the Xen IPK System Programming Manual for additional information.

SERVICE CONDITIONS

- ④ The first two Multiline Terminal ports are programming positions (default: Stations 100 and 101).
- ④ Both stations can go off-line at the same time to program the system.
- ④ When PC Programming is being used with the system, programming from a Multiline Terminal cannot be performed. When programming from a Multiline Terminal is being performed, PC Programming cannot be performed.

GUIDE TO FEATURE PROGRAMMING

Order and Shortcut	System Data Name	Memory Block	Function	1-8-07 Attendant Page-Line Key	1-8-08 Station Page-Line Key
 +BS	Card Interface Slot Assignment	7-1			
 +BS	Telephone Type Assignment	7-2			

THIS PAGE INTENTIONALLY LEFT BLANK

Push Button Dial - DTMF or DP

P-11

FEATURE DESCRIPTION

The Push Button Dial - DTMF or DP feature is provided on all Single Line Telephones and outside lines. Tie Lines are assigned per trunk to generate either Dual-Tone Multifrequency (DTMF) or Dial Pulse (DP) dialling signals.

SYSTEM AVAILABILITY

Terminal Type

All terminals with a push button dial pad.

Required Components

TLI(2)-U() ETU

OPERATING PROCEDURES

Not applicable.

SERVICE CONDITIONS

- ☎ DTMF or DP programming is per Tie line trunk.
- ☎ Single Line Telephones that are installed can be Push Button DTMF or DP (rotary dial).
- ☎ Default assigns DTMF signalling to all trunks and Single Line Telephone ports.
- ☎ DTMF tone can be sent from Multiline Terminals to Dial Pulse trunks.

GUIDE TO FEATURE PROGRAMMING

Order and Shortcut	System Data Name	Memory Block	Function	1-8-07 Attendant Page-Line Key	1-8-08 Station Page-Line Key
 +BS	Card Interface Slot Assignment	7-1			

THIS PAGE INTENTIONALLY LEFT BLANK

Quick Transfer to Voice Mail

Q-1

FEATURE DESCRIPTION

A station user trying to transfer a call can force the call to be transferred to the called party voice mail box. The transfer can be made after the transferred call recalls or while performing a screened transfer to the internal station.

SYSTEM AVAILABILITY

Terminal Type

All Multiline Terminals may perform both types of operations.

Single line telephones may perform the Quick Transfer only during screened transfer operations. They may not perform Quick Transfer after recall.

Required Components

None.

OPERATING PROCEDURES

To quickly transfer a call while talking with an outside party:

1. Press **Transfer**, and receive an internal dial tone.
2. Enter a station number and get a ring back tone.
3. Dial the Quick Transfer Access Code (default: **7** PKS). The outside party is transferred to the station user Voice Mail box.
4. Hang up.
5. The Voice Mail answers.

To quickly transfer a call during a recall:

1. Press the recalling line key.
2. Press **Feature** and dial **8** TUV **6** MND.
3. Hang up.
4. Voice Mail answers.

To quickly transfer a call to voice mail during an intercom call

1. Make the intercom call.
2. Dial the Quick Transfer Access Code (default: ).
3. Leave a voice mail message.
4. Hang up.







**SERVICE
CONDITIONS****Data Assignment**

-  A Voice Mail Master Number must be assigned in Memory Block 1-8-26 in System Programming.



Restrictions

-  The Quick Transfer to Voice Mail is not allowed when caller is:
 - Listening to the busy tone (BT)
 - Talking on an internal line
 - Talking on an outside line
 - During a Broker's call
 - Conference call
 - After setting Automatic Callback

General

-  The Quick Transfer to Voice Mail feature is allowed when:
 - Listening to the ring back tone (RBT)
 - Listening to the call waiting tone (CWT)
 - In Handsfree Answerback Mode
 - In Voice Over Mode
-  This feature is allowed from a Single Line Telephone until the PBR times out (default: 10 sec).
-  When Quick Transfer to Voice Mail is accessed, the Voice Over feature is cancelled.
-  While on an intercom (ICM) call, automatically transfer to that station Voice Mail box by dialling the Quick Transfer Access Code (default 7).
-  When Quick Transfer to Voice Mail is accessed, the Live Recording feature is cancelled.
-  DTR Multiline terminals that have separate "Message" button, will access extension programmed in Memory Block 1-8-26.

GUIDE TO FEATURE PROGRAMMING

Order and Shortcut	System Data Name	Memory Block	Function	1-8-07 Attendant Page-Line Key	1-8-08 Station Page-Line Key
 +BA	Intercom Feature Access Code Assignment	1-2-24	007		
 +AV	* Voice Mail Quick Transfer Master Hunt Number	1-8-26			

* When the system is at default this Memory Block **must** be programmed for the feature to be used.

THIS PAGE INTENTIONALLY LEFT BLANK

Recall Key

R-1

FEATURE DESCRIPTION

The Recall key feature either generates a hookflash to access features provided by the outside exchange or abandons a call while retaining the CO/PBX line for another call. Each Multiline Terminal is equipped with a Recall key. The function of this key is set in System Programming.

SYSTEM AVAILABILITY

Terminal Type

All Multiline Terminals.

Required Components

None.

OPERATING PROCEDURES

To use this feature with an outside CO call in progress:

1. Press .
2. Receive new CO dial tone; line is not released.

To use this feature with a PBX/Centrex call in progress:

1. Press .
2. Receive PBX/Centrex second dial tone.

SERVICE CONDITIONS

Data Assignment

- ⓘ The default duration of the timed disconnect signal or hookflash is 100 milliseconds and is programmable system-wide.
- ⓘ A hookflash can be programmed as any digit in a Speed Dial buffer.
- ⓘ Single Line Telephones can generate a hookflash on a CO/PBX line if allowed in System Programming (system-wide) or by an Access Code.

General

- ⓘ The Recall key functions only on Loop Start Trunks.
- ⓘ A Drop key can be programmed on a Flexible Line key or One-Touch key to be used for abandoning a call and retaining the same PBX/Centrex line.
- ⓘ While receiving busy, error tone, or an internal call, press the Recall key to provide a new internal dial tone.

- ④ If you press the Recall key at an LCR station during a conversation with an outside party and the trunk is assigned as a CO Trunk (using Trunk Type Assignment Memory Block 3-91), the following occurs:
 - The current call is dropped.
 - A new Least Cost Routing dial tone is heard.
 - Station Message Detail Recording starts again.
 - Code Restriction starts again.

- ④ If you press the Recall key during a conversation with an outside party, the trunk is assigned as a PBX Trunk (using the Trunk Type Assignment Memory Block 3-91), and Least Cost Routing Recall is assigned as Allow (using Class of Service Station Selection Memory Block 1-8-08), the following occurs:
 - The current call is held by a PBX trunk.
 - A new PBX dial tone is heard.
 - Station Message Detail Recording starts again.
 - Code Restriction starts again.

- ④ If you press the Recall key during a conversation with an outside party, the trunk is assigned as a PBX Trunk (using Trunk Type Assignment Memory Block 3-91), and Least Cost Routing Recall is assigned as Deny (using Class of Service Station Selection Memory Block 1-8-08), the following occurs:
 - The current call is dropped.
 - A new CO dial tone is heard.
 - Station Message Detail Recording starts again.
 - Code Restriction starts again.





- ④ If you press the Recall key during a conversation with an outside party, the trunk is assigned as a Centrex Trunk Assume-9 (using Trunk Type Selection CTX - Assume-9 Memory Block 3-91), and Least Cost Routing Recall is assigned as Allow (using Class of Service Station Selection Memory Block 1-8-08), the following occurs:
 - The current call is held by a Centrex trunk.
 - A new Centrex dial tone is heard.
 - Station Message Detail Recording starts again.
 - Code Restriction starts again.

- ④ If you press the Recall key during a conversation with an outside party, the trunk is assigned as a Centrex Trunk Assume-9 (using Trunk Type Selection CTX - Assume-9 Memory Block 3-91), and Least Cost Routing Recall is assigned as Deny (using Class of Service Station Selection Memory Block 1-8-08), the following occurs:
 - The current call is dropped.
 - A new CO dial tone is heard.
 - Station Message Detail Recording starts again.
 - Code Restriction starts again.

RELATED FEATURES LIST

Feature Number	Feature Name
C-17	Class of Service
D-18	Drop Key

GUIDE TO FEATURE PROGRAMMING

Order and Shortcut	System Data Name	Memory Block	Function	1-8-07 Attendant Page-Line Key	1-8-08 Station Page-Line Key
 +BCM	* Hookflash Time Selection	1-1-02			
 +BTI	SLT Hookflash Signal Selection	1-3-02			
 +BA	Access Code (1, 2-, 3--Digit) Assignment	1-1-46/47/ 48	029		
 +BM	Class of Service (Station) Feature Selection 2	1-8-08			4-1
 +BTT	Station to Class of Service Feature Assignment	4-17			

* When the system is at default this Memory Block **must** be programmed for the feature to be used.

THIS PAGE INTENTIONALLY LEFT BLANK

Recall With Station Identification

R-2

FEATURE DESCRIPTION

When the call is not answered in a specified time, it recalls with Station Identification. During the recall, the Multiline Terminal display shows the station number that is recalling and the station that did not answer. This feature applies to transferred, held, or camped-on calls.

SYSTEM AVAILABILITY

Terminal Type

Any Multiline Terminal with LCD.

Required Components

None.

OPERATING PROCEDURES

To use this feature from a Multiline Terminal with an LCD:

1. The Multiline Terminal user answers a CO/PBX incoming call.
2. Press **Transfer**, and dial the desired station number.
3. Go on-hook.
4. After the timeout, if the call has not been answered, the recall tone is received and the CO/PBX line key LED intermittently winks. The station number where the call was transferred to is indicated in the LCD.
5. Press the intermittently winking line key, and go off-hook to answer the recall.

SERVICE CONDITIONS

Data Assignment

- ⓘ The recall timer is programmable in System Programming. A separate recall timer is provided for Attendant Positions and stations (default: 60 seconds for both timers).
- ⓘ The ability to Ring Transfer is assigned as Allow or Deny in System Programming (default Allow Ring Transfer).
- ⓘ System Programming allows station identification during a recall to be shown or removed.







General

- ⓘ I-Hold or Call Park result indicates the station number that set these features.

RELATED FEATURES LIST

Feature Number	Feature Name
C-13	Call Park - System
I-1	I-Hold Indication

GUIDE TO FEATURE PROGRAMMING

Order and Shortcut	System Data Name	Memory Block	Function	1-8-07 Attendant Page-Line Key	1-8-08 Station Page-Line Key
 +BM	Hold Recall Time Selection (Non Exclusive Hold)	1-1-03			
 +BM	Station Transfer/Camp-On Recall Time Selection	1-1-12			
 +BM	System Call Park Recall Time Selection	1-2-23			
 +BM	Hold Recall Time Selection (Exclusive)	1-1-63			
 +BM	Attendant Add-On Console Transfer/Camp-On Recall Time Selection	1-1-64			
 +BTM	Hold/Transfer Recall Display Selection	4-30			

Redial Key

R-3

FEATURE DESCRIPTION

Users can press the Redial key and dial the Speed Dial buffer number to access System and Station Speed Dial. Users can also press the Redial key and # to redial the last outside number dialed.

SYSTEM AVAILABILITY

Terminal type

All Multiline Terminals.

Required Components



None.

OPERATING PROCEDURES

To use this feature from a Multiline Terminal:

Last Number Redial

Key Function

1. Press an idle CO/PBX/Tie line key.
2. Press .
3. Dial .





Multifunction (Dial Access)

1. Press .
2. Dial .





Speed Dial.

Multiline Terminal

Key Function



1. Press an idle CO/PBX/Tie line key.
2. Press .
3. Dial Speed Dial buffer number (  ~  ).

Multifunction (Dial Access)

1. Press  .
2. Dial the Speed Dial buffer number (  ~  ).

SERVICE CONDITIONS



General

-  The last outside line number (24 digits maximum) that is dialed is automatically redialled.
-  The Redial key feature can be assigned to a Feature Access or One-Touch key.

RELATED FEATURES LIST

Feature Number	Feature Name
L-2	Last Number Redial
S-10	Speed Dial – Station
S-12	Speed Dial – System

GUIDE TO FEATURE PROGRAMMING

Order and Shortcut	System Data Name	Memory Block	Function	1-8-07 Attendant Page-Line Key	1-8-08 Station Page-Line Key
 +BTS	Class of Service (Station) Feature Selection 2	1-8-08	4-1		
 +BCM	Hookflash Time Selection	1-1-02			

* When the system is at default this Memory Block **must** be programmed for the feature to be used.

Remote Programming

R-4

FEATURE DESCRIPTION

Remote Programming provides a method to modify and save all system parameters from a remote location using a modem. This is a variation of the Maintenance Access Terminal (MAT) PC Programming, and additional software other than PC Programming is not required.

SYSTEM AVAILABILITY

Terminal type

Not Applicable.

Required Components

PC with MAT PC Programming and modem installed at the remote location.

MIFM-U() ETU

MIF-Modem Unit mounted on the MIFM-U() ETU or an external modem connected to the MIFM-U() ETU through COM1.

OPERATING PROCEDURES

Refer to PC Programming Section of the Xen IPK System Programming Manual.

SERVICE CONDITIONS





General

The MIFM-U() ETU must be installed in S1 or S2 of the first B64-U() KSU when the MIF-Modem Unit is installed.

RELATED FEATURES LIST

Feature Number	Feature Name
P-2	PC Programming

GUIDE TO FEATURE PROGRAMMING

Order and Shortcut	System Data Name	Memory Block	Function	1-8-07 Attendant Page-Line Key	1-8-08 Station Page-Line Key
 +BS	Card Interface Slot Assignment	7-1			
 +CSS	* Modem Number for Remote Programming Assignment	1-8-38			
 +BCT	DIT Assignment	3-42			
 +BCT	ANA Assignment	3-43			

* When the system is at default this Memory Block **must** be programmed for the feature to be used.

Resident System Program

R-5

FEATURE DESCRIPTION

When power is supplied to the system, the hardware configuration is scanned and Resident System Program default values are assigned. This enables immediate operation, even before the system is programmed to accommodate the individual site requirements.

SYSTEM AVAILABILITY

Terminal Type
Not applicable.

Required Components
None.

OPERATING PROCEDURES

Not applicable.

SERVICE CONDITIONS

General

- ④ Default assignments for Multiline Terminals are as follows:
 - LK 01~ LK 08 corresponds to CO 01~ CO 08.
- ④ Default assignments for Attendant Add-On Consoles are as follows:
 - DSS1 Port 1
 - DSS 2 Port 2
 - DSS 3 Port 1
 - DSS 4 Port 2

- ④ Default Attendant Add-On Console key assignments are:

DSS Keys	Assignment
01~48	Stations 100~147 (if installed)
49	Night Mode Change
50	Internal Paging Zone A
51	Internal Paging Zone B
52	Internal Paging Zone C
53	All Internal Zone Paging
54	Vacant
55	Message
56	External Speaker A
57	External Speaker B
58	External Speaker C
59	External Speaker All
60	Transfer

- ④ A First Initialisation of the system returns all programming values to default. This can be performed by disconnecting the battery on the CPU()-U() ETU and turning off system power.

Restriction (Outgoing)

R-6

FEATURE DESCRIPTION

The Restriction (Outgoing) feature denies station users the ability to originate outside calls per station/per trunk. At stations where Outgoing Restriction is assigned, users can continue to answer incoming calls, place and receive internal calls, and pick up held lines on a specified trunk. The number of digits dialled on outgoing calls may also be restricted per station.

SYSTEM AVAILABILITY

Terminal Type

All terminals.

Required Components

None.

OPERATING PROCEDURES

Vary, depending on System Programming.

SERVICE CONDITIONS

General

- ⓘ Outgoing Restriction is assigned in System Programming per station/per trunk.
- ⓘ The default program assigns no restrictions to any station.
- ⓘ If you press the Recall key or any key on the dial pad (while receiving dial tone), the CO/PBX line is dropped and reorder tone is sent to the station user.
- ⓘ Restricted outside lines cannot be seized by using a Trunk Access Code.

RELATED FEATURES LIST

Feature Number	Feature Name
C-19	Code Restriction

GUIDE TO FEATURE PROGRAMMING

Order and Shortcut	System Data Name	Memory Block	Function	1-8-07 Attendant Page-Line Key	1-8-08 Station Page-Line Key
 +BTT	* Trunk Outgoing Restriction	4-19			

* When the system is at default this Memory Block **must** be programmed for the feature to be used.

Ringling Line Preference

R-7

FEATURE DESCRIPTION

The Ringling Line Preference feature allows station users to answer any outside line that is ringling in on their station by going off-hook without having to press the Answer key or the Flexible Line key associated with the ringling line.

SYSTEM AVAILABILITY

Terminal Type

All terminals.

Required Components



None.

OPERATING PROCEDURES

To use from a station where Ringling Line Preference is assigned:

1. Lift the handset.
2. Talk with the calling party.

To set/cancel from a Multiline Terminal:

1. Press .
2. Press  .  LED lights solid red.

SERVICE CONDITIONS

Data Assignment





- ⓘ Ringling Line Preference can be allowed via System Programming or can be set by the user.
- ⓘ User programming of Ringling Line Preference can be allowed or denied in Class of Service assignment.

General

- ⓘ Ringling Line Preference only picks up lines that are programmed to ring at that station.
- ⓘ For multiple calls in one of the following priority levels, the Multiline Terminal answers the line that was ringling first:
 1. Voice Announcement or internal ringling call.
 2. Ring transfer calls to a station.
 3. Ringling call on an outside line key.

- ④ When the user sets Ringing Line Preference, the Answer key lights solid red at their station.
- ④ Ringing Line Preference has priority over Prime Line and Hot Line Assignment.
- ④ The CO line that begins ringing first is answered first.
- ④ No stations are assigned this feature at default.

GUIDE TO FEATURE PROGRAMMING

Order and Shortcut	System Data Name	Memory Block	Function	1-8-07 Attendant Page-Line Key	1-8-08 Station Page-Line Key
 +BTM	Ringing Line Preference Selection	4-11			
 +BTM	SIE/CAR Ringing Line Preference Selection	4-41			
 +BTS	Class of Service (Station) Feature Selection 2	1-8-08			3-2
 +BTT	Station to Class of Service Feature Assignment	4-17			

* When the system is at default this Memory Block **must** be programmed for the feature to be used.

Ring Tone Variation

R-8

FEATURE DESCRIPTION

Ring Tone Variation provides three different tone pitches that can be assigned per telephone or per CO/PBX. With this feature, the user can verify priority CO/PBX calls or identify particular ringing stations in an area.

SYSTEM AVAILABILITY

Terminal type
All terminals.

Required Components
None.

OPERATING PROCEDURES

Not Applicable.

SERVICE CONDITIONS



General

- ☎ Telephone or CO/PBX Ring Tone Variation is assigned per station.
- ☎ This feature works closely with the Distinctive Ringing feature and its pattern selections.

RELATED FEATURES LIST

Feature Number	Feature Name
D-13	Distinctive Ringing

GUIDE TO FEATURE PROGRAMMING

Order and Shortcut	System Data Name	Memory Block	Function	1-8-07 Attendant Page-Line Key	1-8-08 Station Page-Line Key
 +BTS	Distinctive Ringing by Telephone or CO Selection	1-1-28			
 +BCT	CO/PBX Ringing Variation Selection	3-07			
 +BTM	Telephone Ringing Variation Selection	4-91			

Route Advance Block

R-9

FEATURE DESCRIPTION

The Route Advance Block feature allows up to 32 tables to be assigned. Each table may contain four Trunk group priority levels from lowest cost to most expensive. A station user may have a Route Advance key programmed on their telephone or may access this feature using a Trunk Access Code. When placing an outside call, the system follows the Route Advance table assigned for the station, ensuring that the lowest cost available Trunk group is used. Any Trunk group can be assigned to multiple route advance priority tables.

SYSTEM AVAILABILITY

Terminal Type

All terminals.

Required Components

None.

OPERATING PROCEDURES

To use this feature from a Multiline Terminal:

1. Press a line key assigned for a Route Advance Block.
2. Dial the desired number.

To use this feature from any station:

1. Lift the handset, and receive internal dial tone.
2. Dial a Route Advance Block Access Code.
3. Dial the desired number.

SERVICE CONDITIONS

Data Assignment

- ④ The 32 Route Advance Blocks can be programmed in System Programming.
- ④ Up to four Trunk groups can be programmed in one Route Advance Block priority table.
- ④ Trunk groups can be repeated in multiple priority tables.







Restrictions

- ⓘ The system must be assigned as MF registration.

General

- ⓘ Outgoing Restriction and Code Restriction rules apply to stations dialling out via Route Advance Blocks.
- ⓘ The line key assigned for a Route Advance Block does not light when all trunks and Trunk groups assigned to the Route Advance Block are busy.
- ⓘ Stations are allowed to set Trunk Queuing to a Route Advance Block.

GUIDE TO FEATURE PROGRAMMING

Order and Shortcut	System Data Name	Memory Block	Function	1-8-07 Attendant Page-Line Key	1-8-08 Station Page-Line Key
 +BCT	Trunk-to-Trunk Group Assignment	3-03			
 +BCS	* Route Advance Block Assignment	1-1-30			
 +BA	Access Code (1-, 2-, or 3-Digit) Assignment	1-1-46/47/ 48	201 ~ 232		
 +BTM	Line Key Selection for Telephone Mode	4-12			
 +BN	Line Key Selection	2-05			
 +BN	Line Key Selection for Tenant Mode	2-06			
 +ALN	Trunk Group Outgoing Priority Selection	5-06			

* When the system is at default this Memory Block **must** be programmed for the feature to be used.

Save and Repeat

S-1

FEATURE DESCRIPTION

The Save and Repeat feature allows a Multiline Terminal user to save the last outside number dialed in system memory for later use.

SYSTEM AVAILABILITY

Terminal Type

All Multiline Terminals.

Required Components

None.

OPERATING PROCEDURES

To use this feature with an outgoing CO/PBX call in progress:

1. Press **Feature**.
2. Dial **9**.
3. The last number that was dialed is saved into memory.
4. Restore the handset or press **Speaker**.

To repeat saved number:

Key Function

1. Press **Redial**.
2. Dial *****.

Multifunction (Dial Access)

1. Press **Redial**.
2. Dial *****.

SERVICE CONDITIONS

Restrictions

- ☎ Save and Repeat is valid on outside line calls only.

General

- ☎ Only one number (24 digits maximum) can be saved in the memory of each Multiline Terminal.
- ☎ The saved number is retained in memory by the memory backup battery.

- ④ A new number can be saved over the last Save and Repeat Number.
- ④ The Save and Repeat and the Store and Repeat features cannot be simultaneously used from a Multiline Terminal. The same memory area is shared by both features.
- ④ The user can program a Feature Access key or a One-Touch key as a Save key. A second Feature Access key or a One-Touch key can be assigned as a Repeat key. The LED does not light when a number is saved.

RELATED FEATURES LIST

Feature Number	Feature Name
S-1	Save and Repeat

Scrolling Directories

S-2

FEATURE DESCRIPTION

The Scrolling Directories feature functions like a telephone directory. It provides the user of a *D^{term}* Series i Multiline Terminal with Softkeys a list of system and/or station speed dialling numbers. Using the softkeys, the user can select a speed dial number and then dial the number by pressing the Speaker key or by lifting the handset.

SYSTEM AVAILABILITY

Terminal Type



All display Multiline Terminals with Softkeys.

Required Components

None.

OPERATING PROCEDURES

To use this feature:



1. Press the  (SYS or STA) softkey to designate system or station speed dialling.
2. Press the  (UP or DOWN) softkey to view the names/numbers listed in the directory.

- OR -

Press a dial pad key (repeatedly if necessary, to select the first letter of the name or number of the desired speed dial buffer) and .

3. To dial the number press  or lift the handset.

To use this feature with Account Code - Forced/Verified/Unverified:

1. Press the  (SYS or STA) softkey to designate system or station speed dialling.
2. Press the  (UP or DOWN) softkey to view the names/numbers listed in the directory.

- OR -

Press a dial pad key (repeatedly if necessary, to select the first letter of the name or number of the desired speed dial buffer) and .

3. To dial the number press  or lift the handset.
4. Enter the Account Code.

SERVICE CONDITIONS

Data Assignment

- ④ Use Memory Block 1-1-18 (System Speed Dial Restriction by Tenant) to specify whether or not System Speed dial is restricted for tenants. (Default: 00, unrestricted).
- ④ Use Memory Block 1-1-33 (Speed Dial Number/Name Display Selection) to specify whether the dialled number (default: DIAL) or NAME is displayed first on the LCD when an outgoing call is made using speed dial.
- ④ Use Memory Block 1-1-35 (Speed Dial Buffer Allocation) to select either the 100-memory (default) or 1000-memory speed dial buffer allocation.
- ④ Use Memory Block 2-07 (System Speed Dial Display Assignment) to specify whether (LED On) or not (LED off) confirmation of speed Dial numbers and messages stored in Speed Dial Memory is allowed (100-memory default: All Page 1 LEDs On).

Restrictions

- ④ Scrolling Directories can be done only while the station is idle.
- ④ When the *System Speed Dial Display Assignment* is used to restrict Tenants from viewing the numbers stored in System Speed Dial buffers, the scrolling follows these conditions:
 - If both Name and Number are stored, the users can scroll System Speed Dial buffers.
 - If only the Number is stored, the users cannot scroll System Speed Dial buffers.
- ④ When System or Station Speed Dial data is stored or changed by PC Programming, the changes are not displayed by the scrolling feature until the PC Programming connection is released.





General

- ④ Account Code - Forced/Verified/Unverified can be used with the feature.
- ④ Names/numbers can be found in the directory in two ways:
 - Scroll the list using the \triangle (UP or DOWN) softkey.
 - Search by entering a letter or digit using the dial pad keys.
- ④ Both the name and number can be stored in the directory. If both are stored, only the name is shown in the LCD.
- ④ The third line of the LCD displays the softkey designations, which are:
 - SYS = System Speed Dial Numbers.
 - STA = Station Speed Dial Numbers.
 - UP = Moves up to display additional System or Station Speed Dial numbers.
 - DOWN= Moves down to display additional System or Station Speed Dial numbers.

- ④ If the Feature key or digit key is not pressed within 10 seconds, scrolling is cancelled.
- ④ When scrolling, the system uses the following criteria to display the information in the order listed below:
 - Spaces (between alphabetical characters)
 - Alphabetical Characters
 - Digits
 - Special Characters
- ④ If more than one entry has the same name, the Speed Dial buffer with the lowest number is displayed first (*i.e.*, buffer 04 is displayed before buffer 08).
- ④ Users can only scroll Speed Dial buffers that are included in their Tenant Group.
- ④ The spaces programmed in the beginning of a name are ignored during scrolling for sorting (*i.e.*, ^^Jean would be regarded as Jean).
- ④ The speed dial buffers can be manually searched by scrolling through the Speed Dial Directory or the search can be narrowed down to the first letter of the name or first digit of the phone number. For the first letter of the name, the user can use the dial pad key with that letter on it. For example to search for NEC, the user dials 66* (*i.e.*, 6 has three letters, M, N and O). Dial 66 to reach names starting with alphabet N and press * to be used as an Enter key. The LCD displays the name(s) starting with N. The user can then scroll down to the applicable name and make a selection.
- ④ Dial Pad 0 - 9 is valid for searching. The following shows the relation between Dial Pad and Alphabet/Digit:
 - Dial Pad 0 = 0
 - Dial Pad 1 = 1
 - Dial Pad 2 = ABC2
 - Dial Pad 3 = DEF3
 - Dial Pad 4 = GHI4
 - Dial Pad 5 = JKL5
 - Dial Pad 6 = MNO6
 - Dial Pad 7 = PQRS7
 - Dial Pad 8 = TUV8
 - Dial Pad 9 = WXYZ9
- ④ If the system is programmed as Key Function, a number is dialled by selecting the number in the display and pressing an idle trunk line key.
- ④ When the user is viewing the directory to select the number to be dialled, the station is in similar status as User Programming Mode. In this case an incoming call to that station is treated in the same way as a call to a User Programming Mode station.

- ④ Scrolling mode is cancelled when one of the following keys are pressed: Hold, Transfer, Answer, Redial, One-Touch, or Feature Access.
- ④ Key operation is ignored when Conf or Recall is pressed during scrolling.
- ④ A maximum 12 characters are displayed in the Multiline Terminal LCD if the system is programmed for 1000 System Speed Dial numbers.
- ④ A maximum 13 characters are displayed in the Multiline Terminal LCD for Station Speed Dial or if programmed for 100 System Speed Dial numbers.
- ④ If the stored name/number exceeds 12 or 13 characters, only the first 12 or 13 characters are displayed in the Multiline Terminal LCD.

GUIDE TO FEATURE PROGRAMMING

Order and Shortcut	System Data Name	Memory Block	Function	1-8-07 Attendant Page-Line Key	1-8-08 Station Page-Line Key
 +BE	Speed Dial Number/Name Display Selection	1-1-33			
 +BE	Speed Dial Buffer Allocation	1-1-35			
 +BN	System Speed Dial Display Assignment	2-07			
 +AC	System Speed Dial Restriction by Tenant	1-1-18			

Secondary Incoming Extension

S-3

FEATURE DESCRIPTION

Secondary Incoming Extensions can be assigned on Flexible Line keys. The status of the Secondary Incoming Extension appears on the LED of the Secondary Incoming Extension that is assigned. An incoming internal, ringing Tie/DID, DIT/ANA, CO Transfer Ring, or call forwarded call can be picked up from a Secondary Incoming Extension.

SYSTEM AVAILABILITY

Terminal Type

All Multiline Terminals.

Required Components

None.

OPERATING PROCEDURES

To answer a secondary incoming extension call:

1. Receive an incoming ringing call on a Secondary Incoming Extension key.
2. Press the Secondary Incoming Extension key or go off-hook if Ringing Line Preference is assigned, and receive the call.
3. Talk with party. (Normal call handling procedures apply.)

SERVICE CONDITIONS

Data Assignment

- ☎ Any or all line keys can be assigned as Secondary Incoming Extensions.
- ☎ A separate Day or Night Mode ringing assignment is available.

Restrictions







- ☎ A station number cannot be programmed as a Secondary Incoming Extension on multiple Flexible Line keys on a Multiline Terminal.
- ☎ Intercom voice signalling to another station cannot be picked up at the Secondary Incoming Extension. In this case, the LED on the Secondary Incoming Extension indicates Idle.

General

- ☎ Recalls to a station do not appear or ring on a Secondary Incoming Extension.
- ☎ Tone Override and Camp-On calls to a station appear and/or ring on a Secondary Incoming Extension.

- ☎ Calls cannot be originated from a Secondary Incoming Extension.
- ☎ Off-Hook Ringing is provided with calls ringing into Secondary Incoming Extensions.
- ☎ Secondary Incoming Extensions cannot be set for Call Forward.
- ☎ Internal and outside line calls answered from a Secondary Incoming Extension become the answering station user call.
- ☎ Off-Hook indication (BLF) is not provided on the Secondary Incoming Extension.
- ☎ If a Secondary Incoming Extension call is received and answered while the user is also engaged in an internal or outside line call, the first call is automatically put on hold.

GUIDE TO FEATURE PROGRAMMING

Order and Shortcut	System Data Name	Memory Block	Function	1-8-07 Attendant Page-Line Key	1-8-08 Station Page-Line Key
 +BTM	* Line Key Selection for Telephone Mode	4-12			
 +BTM	Extension Line Key Ring Assignment (Day Mode)	4-37			
 +BTM	Extension Line Key Ring Assignment (Night Mode)	4-38			
 +BTM	SIE/CAR Ringing Line Preference Selection	4-41			
 +BN	Line Key Selection	2-05			
 +BN	Line Key Selection for Tenant Mode	2-06			

* When the system is at default this Memory Block **must** be programmed for the feature to be used.

Seized Trunk Name/ Number Display

S-4

FEATURE DESCRIPTION

The Seized Trunk Name/Number Display feature displays the telephone name or number (assigned in System Programming) of each trunk in the system. These names or numbers appear on the Multiline Terminal LCD when a trunk is seized.

SYSTEM AVAILABILITY

Terminal Type



All Multiline Terminals with an LCD.

Required Components

None.

OPERATING PROCEDURES

For an outside call in progress (after Elapsed Call Timer starts):

1. Press .
2. Dial .
3. The trunk number and assigned name or number are briefly displayed.

SERVICE CONDITIONS

Data Assignment

- ④ Each of the 64 available trunks for Xen IPK Expanded or the 16 available trunks for the Xen IPK Basic can be assigned a name or telephone number. The assigned name/number cannot be more than 13 character digits (including spaces and dashes).

Restrictions

- ④ During a conference call, the seized trunk Name/Number is not displayed.

General

- ④ For outgoing calls, the Name/Number assigned is displayed when an outside line is seized until a digit is dialled or the line is dropped.
- ④ For incoming or transferred calls, and calls removed from hold, the Name/Number is displayed briefly (five seconds) after the line is accessed. The Elapsed Call Timer begins immediately after the trunk Name/Number is displayed.

GUIDE TO FEATURE PROGRAMMING

Order and Shortcut	System Data Name	Memory Block	Function	1-8-07 Attendant Page-Line Key	1-8-08 Station Page-Line Key
 +BCT	* Trunk Name/Number Assignment	3-00			

* When the system is at default this Memory Block **must** be programmed for the feature to be used.

Simplified Call Distribution

S-5

FEATURE DESCRIPTION

Simplified Call Distribution is a hunting method that distributes calls evenly to all members of a hunt group. It is very similar to UCD but does not require members to control call processing status by logging off. Hunting is instituted when a DIT, DID, TIE or VRS(4)-U() ETU call is terminated at an SCD group pilot number. Up to 32 SCD members can be divided among four SCD groups or assigned in one SCD group.

SYSTEM AVAILABILITY

Terminal Type

Not applicable.

Required Components

None.

OPERATING PROCEDURES

Not applicable.

SERVICE CONDITIONS

Data Assignment

- Both the SCD pilot number and SCD members are assigned in System Programming.

Restrictions





- SCD is not available for Voice Mail transferred calls, CO transferred calls, or station transferred calls.
- SCD is not available for intercom calls.
- SCD calls do not follow individual settings of CFB/NA.
- SCD calls will not follow any Call Forward Split setting. Setting a Call Forward Split on an SCD agent will cause that agent to be bypassed by SCD calls. Directed calls to that station (e.g. DID, DIT or Ring Transferred calls) will however follow the Call Forward Split settings as appropriate.

General

- The hunt method for SCD is circular. The hunting starts with the station after the last answered SCD station within a group.
- SCD calls follow Station Call Forward - All settings to an internal destination, however when calls terminate at the CF-All destination, if a call is not answered within the time specified in MB1-2-22, it will ring at next SCD agent.

- ④ If an SCD call is unanswered the Xen IPK system uses the Call Forward - No Answer timer to send the call to the next available SCD station. This forward on no answer is a single event and does not repeat itself for the duration of that SCD call.
- ④ Calls to an SCD group must be transferred to an agent and not the pilot.
- ④ SCD group can have a hunt on busy set using MB4-14 and MB4-15.
- ④ Call Arrival (CAR) keys can be assigned as members of an SCD group.

GUIDE TO FEATURE PROGRAMMING

Order and Shortcut	System Data Name	Memory Block	Function	1-8-07 Attendant Page-Line Key	1-8-08 Station Page-Line Key
 +AA	* SCD (Simplified Call Distribution) Pilot Number Assignment	1-8-29			
 +AA	* SCD Group Agent Assignment	1-8-30			
 +BCT	DIT Assignment	3-42			
 +BCT	ANA Assignment	3-43			

* When the system is at default this Memory Block **must** be programmed for the feature to be used.

Single Line Telephone Access

S-6

FEATURE DESCRIPTION

The Xen IPK system provides for the connection of a maximum of 118 Single Line Telephones (SLTs). Single Line Telephone users can make CO/PBX calls, internal calls, and paging calls.

SYSTEM AVAILABILITY

Terminal Type
Single Line Telephones.

Required Components

OPX(2)-U() ETU

SLI(8)-U() ETU

SLI(4)-U() ETU

SLT(1)-U() ADP connected to a ESIB/ESIE(8)-U() ETU port

AP(R)-R() Unit connected to a Multiline Terminal

OPERATING PROCEDURES

To originate an internal calls:

1. Lift the handset, and receive internal dial tone.
2. Dial the applicable station number.
3. Talk when called party answers.

To originate outside calls:

1. Lift the handset, and receive internal dial tone.
2. Dial Trunk Access Code (default: $\textcircled{0}$).
3. Dial the number of outside party.
4. Talk when the called party answers.

To answer outside or internal calls:

Lift the handset and converse.

To transfer an outside call or internal call with a call in progress:

1. Press the hookswitch momentarily, and receive internal dial tone.
2. Dial the station number where call is to be transferred.
3. Hang up.

To access feature:

1. Lift the handset, and receive internal dial tone.
2. Dial the Feature Access Code.

**SERVICE
CONDITIONS****Data Assignment**

- ④ All Feature Access Codes can be used from a Single Line Telephone if allowed by Station Class of Service.
- ④ Internal and outside calls may be held and transferred by pressing the hookswitch. This is determined in System Programming. The choices are:
 1. Press hookswitch for internal hold.
 2. Press hookswitch to send a Hookflash to the outside line.
- ④ If a rotary type Single Line Telephone is used, Access Codes using # and  must be changed to numerical digits because this telephone does not support these digits.

Restrictions

- ④ The SLT(1)-U() ADP and OPX(2)-U() ETU do not support the Message Waiting feature.

General











- ④ Single Line Telephones provide a distinctive ringing pattern between CO/PBX incoming calls and internal calls.
- ④ Both DTMF type and Rotary type Single Line Telephones can be used with the system.
- ④ Message Wait LEDs light if a message is sent to a Single Line Telephone with Message Wait LED.
- ④ A Single Line Telephone can be used to voice announce to a Multiline Terminal.
- ④ Default Access Code 6# can be used to send a hookflash from a Single Line Telephone to an outside line.

- ⓘ After the PBR is released, DTMF tones from a Single Line Telephone are not detected by the system but are sent directly to the CO/PBX line.
- ⓘ If Data Line Security is assigned for a Single Line Telephone, override tones are denied to this station.
- ⓘ When a Single Line Telephone is called, no PBR is connected to that Single Line Telephone. Therefore, no features can be set at that time.









RELATED FEATURES LIST

Feature Number	Feature Name
A-7	Ancillary Device Connection
C-24	Cordless Telephone Connection

GUIDE TO FEATURE PROGRAMMING

Order and Shortcut	System Data Name	Memory Block	Function	1-8-07 Attendant Page-Line Key	1-8-08 Station Page-Line Key
 +BS	* Card Interface Slot Assignment	7-1			
 +BTI	Voice Mail/SLT Selection	4-35			
 +BTI	DTMF/DP SLT Type Selection	4-95			
 +BTI	SLT Hookflash Assignment	4-24			
 +BTI	Dial 1 (DP) Hookflash Selection	1-3-04			
 +BTI	SLT Hookflash Signal Selection	1-3-02			
 +BTI	SLT or Automated Attendant/DISA to PBR Selection	1-8-01			
 +BTI	First Digit PBR Release Time Selection	1-3-03			
 +BTI	Hookflash Start Time Selection	1-3-05			
 +BTI	Hookflash End Time Selection	1-3-06			

Doc. No. 8201 - Release 1.0
July 2003

Order and Shortcut	System Data Name	Memory Block	Function	1-8-07 Attendant Page-Line Key	1-8-08 Station Page-Line Key
 +BTI	Bounce Protect Time Selection	1-3-01			
 +BTT	Station Name Assignment	4-18			
 +BTT	Telephone to Tenant Assignment	4-09			
 +BTT	SLT Data Line Security Assignment	4-90			
 +BTT	CO/PBX Ring Assignment (Day Mode)	4-01			
 +BTT	CO/PBX Ring Assignment (Night Mode)	4-02			
 +BCT	DIT Assignment	3-42			
 +BCT	ANA Assignment	3-43			

* When the system is at default this Memory Block **must** be programmed for the feature to be used.

FEATURE DESCRIPTION

The Single Line Telephone (SLT) Adapter allows a port of an ESIB/ESIE(8)-U() ETU to support a Single Line Telephone. A Single Line Telephone can be connected to the ESI port using the SLT Adapter and 2-wire cable. Seven SLT(1)-U() ADP Single Line Telephone Adapters can be installed in the Xen IPK system.

SYSTEM AVAILABILITY

Terminal Type

Single Line Telephones.

Required Components

SLT(1)-U() ADP

ESIB(8)-U() ETU or ESIE(8)-U() ETU

OPERATING PROCEDURES

To originate internal calls:

1. Lift the handset, and receive internal dial tone.
2. Dial the applicable internal number.
3. Talk when called party answers.

To originate outside calls:

1. Lift the handset, and receive dial tone.
2. Dial Trunk Access Code (default: 0).
3. Dial the number of outside party.
4. Talk when the called party answers.

To answer outside or internal calls:

Lift the handset and converse.

To transfer an outside call or internal call with a call in progress:

1. Press the hookswitch momentarily, and receive second dial tone.
2. Dial the station number where call is to be transferred.
3. Hang up.

To access the feature:

1. Lift the handset, and receive internal dial tone.
2. Dial the applicable Feature Access Code.

SERVICE CONDITIONS

Data Assignment

- ☎ The station must be specified as an SLT in System Programming.



Restrictions

- ☎ Message Waiting LED is not supported.
- ☎ SLT(1)-U() ADPs do not support the connection of a voice mail system.

General

- ☎ A maximum of 7 SLT(1)-U() ADP units can be used in the Xen IPK system.
- ☎ Dial Pulse and Dual-Tone Multifrequency Single Line Telephones are supported.

GUIDE TO FEATURE PROGRAMMING

Order and Shortcut	System Data Name	Memory Block	Function	1-8-07 Attendant Page-Line Key	1-8-08 Station Page-Line Key
 +BS	* Telephone Type Assignment	7-2			
 +BS	Station Number Assignment	4-10			

* When the system is at default this Memory Block **must** be programmed for the feature to be used.

SLT Timed Alarm

S-8

FEATURE DESCRIPTION

A Timed Alarm (reminder) may be set at any Single Line Telephone. At programmed intervals, the system automatically calls the SLT station user to remind the user of a scheduled time.

SYSTEM AVAILABILITY

Terminal Type

All terminals.

Required Components

Any Single Line Telephone port.

OPERATING PROCEDURES

To set Timed Alarm from a Single Line Telephone:

1. Lift the handset, and receive internal dial tone.
2. Dial the Timed Alarm set Access Code _____ (not assigned at default).
3. Enter time for the alarm (24-hour format in 5-minute increments).
4. Restore the handset.





To cancel Timed Alarm from a Single Line Telephone:

1. Lift the handset, and receive internal dial tone.
2. Dial Timed Alarm cancel Access Code _____ (not assigned at default).
3. Restore the handset.

To set Timed Alarm for a Single Line Telephone from a Multiline Terminal (Attendant Position only):

1. Lift the handset or press , and receive internal dial tone.
2. Dial the Timed Alarm set/cancel to Single Line Telephone Access Code _____ (not assigned at default).
3. Dial the Single Line Telephone station number.
4. Enter time to set the alarm (24-hour format in 5-minute increments).
5. Restore the handset.

To cancel Timed Alarm for a Single Line Telephone from a Multiline Terminal (Attendant Position only):

1. Lift the handset or press , and receive internal dial tone.
2. Dial the Timed Alarm set/cancel to Single Line Telephone Access Code _____ (not assigned at default).
3. Dial the Single Line Telephone station number.
4. Enter time as   :   .
5. Restore the handset.





To cancel Timed Alarm (system-wide) from a Multiline Terminal (Attendant Position only):

1. Press  .
2. Dial   .
3. Press  .

SERVICE CONDITIONS

- ⓘ Timed Alarm must be set in five-minute increments for Single Line Telephones using a 24-hour format. For example: 12:10, 12:15,...23:55.
- ⓘ A Timed Alarm rings for four minutes if not answered.
- ⓘ When Timed Alarm is answered, the user hears Music On Hold.
- ⓘ SLT Timed Alarm must be set daily.

GUIDE TO FEATURE PROGRAMMING

Order and Shortcut	System Data Name	Memory Block	Function	1-8-07 Attendant Page-Line Key	1-8-08 Station Page-Line Key
 +BTS	Class of Service (Attendant) Feature Selection 1	1-8-07		2-1	
 +BTS	Class of Service (Station) Feature Selection 2	1-8-08			1-6
 +BTT	Station to Class of Service Feature Assignment	4-17			
 +BA	Access Code (1-, 2-, or 3-Digit) Assignment	1-1-46/47/ 48	044~046,		

Softkeys

S-9

FEATURE DESCRIPTION

The Xen IPK system provides softkeys on all D^{term} Series i display (DTR) and DTU-Type Multiline Terminals. Currently Speed Dial Scrolling Directories, Account Code - Forced/Verified and XenMail Digital Voice Mail systems make extensive use of these keys to guide a station user effortlessly through difficult to use feature operations.

SYSTEM AVAILABILITY

Terminal Type

All Multiline Terminals with Display and Softkeys.

Required Components

None.

OPERATING PROCEDURES

Not applicable.

SERVICE CONDITIONS

- ⓘ The three features that currently use softkeys are Scrolling Directories, ACD Plus and Voice Mail applications supported by the FMS(2)/(4)-U() or VMS(2)/(4)/(8)-U() ETU.

THIS PAGE INTENTIONALLY LEFT BLANK

Speed Dial – Station

S-10

FEATURE DESCRIPTION

When 100-memory allocation is specified, each station in the system can be assigned 20 Station Speed Dial buffers. Each Station Speed Dial buffer may contain 24 digits or four other buffer numbers (Nesting Dial) and the called party name. The DTR-32D-1A TEL and DTU-32D-1A TEL have 16 One-Touch keys that can also be used for Speed Dial. The One-Touch key buffer may contain a maximum of 16 digits with no characters for names. These keys can be used for station speed dialling in addition to the 20 Station Speed dial buffers.

SYSTEM AVAILABILITY

Terminal Type

All terminals.

Required Components

None.

OPERATING PROCEDURES

To program a Station Speed Dial buffer from a Multiline Terminal:

1. Press **Feature**.
2. Press **Redial**.
3. Dial the Station Speed Dial buffer number to be programmed (**8** **0** ~ **9** **9**).
4. Dial the Trunk or Trunk Group Access Code (maximum four digits).
5. Dial the desired telephone number.
6. Press **Hold**, and enter a name using the dial pad characters (optional step). Refer to Section S-11 Speed Dial Stored Characters.
7. Press **Feature**.

To program a Feature Access key for Station Speed Dial from a Multiline Terminal:

1. Press **Feature**.
2. Press **Redial**.
3. Press the Feature Access key.
4. Dial **0**.
5. Dial the Trunk or Trunk Group Access Code (maximum four digits).
6. Dial the desired telephone number.
7. Press **Feature**.

To program a One-Touch key for Station Speed Dial from a Multiline Terminal:

1. Press **Feature**.
2. Press **Redial**.
3. Press the One-Touch key.
4. Dial **0**.
5. Dial the Trunk or Trunk Group Access Code (maximum four digits).
6. Dial the desired telephone number.
7. Press **Feature**.

To program a Station Speed Dial buffer from a Single Line Telephone:

1. Lift the handset, and receive internal dial tone.
2. Dial the Station Speed Dial Program Access Code (default: **7** **6**).
3. Dial the Station Speed Dial buffer number to be programmed (**8** **0** ~ **9** **9**).
4. Dial the Trunk or Trunk Group Access Code (maximum four digits).
5. Dial the telephone number to be stored.
6. Restore the handset.

To use a Station Speed Dial buffer from a Multiline Terminal:

1. Press **Redial**.
2. Dial the Station Speed Dial buffer number (**8** **0** ~ **9** **9**).

To use a Feature Access or One-Touch key programmed for Station Speed Dial from a Multiline Terminal:

1. Press the desired Feature Access or One-Touch key.

To use a Station Speed Dial Buffer from a Single Line Telephone:

1. Lift the handset, and receive internal dial tone.
2. Dial the Station Speed Dial Access Code (default: *).
3. Dial the Station Speed Dial buffer number ($\overline{8}$ $\overline{0}$ ~ $\overline{9}$ $\overline{9}$).
4. Talk with the called party.

SERVICE CONDITIONS

Data Assignment

- An 80 or 1000 System Speed Dial is Assigned in System Programming.

General





- A maximum of 24 digits can be programmed into a Speed Dial buffer.
- A maximum of 16 Feature Access keys per station can be programmed on unused line keys. A maximum of 16 digits can be programmed into each Feature Access key.
- A maximum of 16 digits can be programmed into a One-Touch key.
- A maximum of 13 characters using 80 System Speed Dial Mode or 12 characters using 1000 System Speed Dial mode can be entered for the name.
- One-Touch keys programmed as Station Speed Dial cannot have a name stored with the number to dial.
- A pause, $\overline{\text{Redial}}$, and # may be programmed into a Multiline Terminal Station Speed Dial buffer. Each item is counted as a digit; however, the Trunk and Trunk Group Access Code do not count as digits.
- A pause and hookflash can be programmed into a Single Line Telephone Station Speed Dial buffer, but only when using the Xen IPK System Programming Technician Software.
- Pauses should not be stored in systems with the Least Cost Routing (LCR) feature. These pauses may cause the MIFM-U() ETU with KMM()UA to seize a Least Cost Route because the pauses may be considered digits dialed. In systems using the LCR feature, pauses should be programmed as part of extra codes in the Extra Code Add Table.
- The built-in battery backup on the CPUI()-U() ETU retains Station Speed Dial memories if power fails.

- ④ Multiline Terminals with an LCD display can verify Station Speed Dial buffer contents by pressing the Conference key, then the Redial key, and then dialling the Station Speed Dial buffer (80~99).
- ④ Multiline Terminals with an LCD display can verify Station Speed Dial buffer contents programmed on a Feature Access or One-Touch key by pressing the Feature key and then pressing the Feature Access or One-Touch key.
- ④ Multiline Terminal users may access two or more Station Speed Dial buffers by using the Consecutive Speed Dial feature.

RELATED FEATURES LIST

Feature Number	Feature Name
C-23	Consecutive Speed Dial
F-1	Feature Access – User Programmable
S-12	Speed Dial – System
N-1	Nesting DialNesting Dial

GUIDE TO FEATURE PROGRAMMING

Order and Shortcut	System Data Name	Memory Block	Function	1-8-07 Attendant Page-Line Key	1-8-08 Station Page-Line Key
 +BE	Speed Dial Buffer Allocation	1-1-35			
 +BE	Speed Dial Number/Name Display Selection	1-1-33			
 +BTM	Line Key Selection for Telephone Mode	4-12			
 +BA	Access Code (1-, 2-, or 3-Digit) Assignment	1-1-46/47/ 48	090, 095		

Speed Dial Stored Characters

S-11

FEATURE DESCRIPTION

Each Multiline Terminal in the system may be assigned 20 Station Speed Dial buffers. Depending on System Programming, if 1000 additional System Speed Dial numbers are assigned, the stations do not have Station Speed Dial. Station Speed Dial buffers may contain a maximum of 24 digits and 13 alphanumeric characters for storing a name associated with the number.

SYSTEM AVAILABILITY

Terminal Type

All Multiline Terminals equipped with LCDs.

Required Components

None.

OPERATING PROCEDURES

To program a Station Speed Dial buffer with stored characters:

1. Press **Feature**.
2. Press **Redial**.
3. Dial the Station Speed Dial buffer number to be programmed (**8** **0** ~ **9** **9**).
4. Dial the Trunk or Trunk Group Access Code (maximum four digits).
5. Dial the desired telephone number.
6. Press **Hold**, and enter a name using the Dial Pad character Assignment table at the end of this feature.
7. Press **Feature**.

To program a Feature Access key for Station Speed Dial with stored characters:

1. Press **Feature**.
2. Press **Redial**.
3. Dial the Station Speed Dial buffer number to be programmed (**8** **0** ~ **9** **9**).
4. Dial **0**.
5. Dial the Trunk or Trunk Group Access Code (maximum four digits).

6. Dial the desired telephone number.
7. Press **Hold** , and enter a name using the dial pad character codes.
8. Press **Feature** .

To program a System Speed Dial buffer with stored characters (Attendant Position only):

1. Press **Feature** .
2. Press **Redial** .
3. Dial the System Speed Dial buffer number to be programmed (**0** **0** ~ **7** **9** or **0** **0** **0** ~ **9** **9** **9**).
4. Dial the Trunk or Trunk Group Access Code (maximum four digits).
5. Dial the desired telephone number.
6. Press **Hold** , and enter a name using the dial pad character codes.
7. Press **Feature** .

To use a Speed Dial buffer with stored characters:

1. Press **Redial** .
2. Dial the Speed Dial buffer number (**0** **0** ~ **9** **9** or **0** **0** **0** ~ **9** **9** **9**).

To use the Feature Access key for Station Speed Dial with stored characters:

1. Press the desired Feature Access key.

SERVICE CONDITIONS

Data Assignment

- ④ The 80 or 1000 Speed Dial Mode is Assigned in System Programming.
- ④ In System Programming, the name can be assigned to be displayed first, followed by the number dialled, or the number dialled followed by the name (default: number dialled first, then the name).

Restrictions

- ④ One-Touch keys, programmed as Station Speed Dial, cannot have a name stored with the number to dial.

General

- ④ A maximum of 13 characters, using 80 System Speed Dial Mode, or 12 characters, using 1000 System Speed Dial Mode, can be entered for the name.
- ④ When programming Feature Access or One-Touch keys, the Conference key can be used to backspace and erase an entry.
- ④ Stored characters can only be entered for outside line numbers.



RELATED FEATURES LIST

Feature Number	Feature Name
F-2	Feature Access - User Programmable
N-1	Nesting Dial
S-9	Speed Dial - Station
S-10	Speed Dial - System

Table 2-1 Dial Pad Character Assignment

Button	Key Press													
	1st	2nd	3rd	4th	5th	6th	7th	8th	9th	10th	11th	12th	13th	14th
1	1	@	[¥]	^	_	'	{		}	ä	â	Back to 1
2	A	B	C	a	b	c	2	Back to A						
3	D	E	F	d	e	f	3	Back to D						
4	G	H	I	g	h	i	4	Back to G						
5	J	K	L	j	k	l	5	Back to J						
6	M	N	O	m	n	o	6	Back to M						
7	P	Q	R	S	p	q	r	s	7	Back to P				
8	T	U	V	t	u	v	8	Back to T						
9	W	X	Y	Z	w	x	y	z	9	Back to W				
0	0	!	"	#	\$	%	&	'	()	Back to 0			
*	*	+	,	-	.	/	:	;	<	=	>	?	Back to *	
#	Set	Space	Back to Set											
Conf	clear and back 1 character before cursor													

GUIDE TO FEATURE PROGRAMMING

Order and Shortcut	System Data Name	Memory Block	Function	1-8-07 Attendant Page-Line Key	1-8-08 Station Page-Line Key
 +BE	Speed Dial Number/Name Display Selection	1-1-33			
 +BE	Speed Dial Buffer Allocation	1-1-35			
 +BN	System Speed Dial Display Assignment	2-07			

Speed Dial – System

S-12

FEATURE DESCRIPTION

Attendant Positions can be used to program up to 1000 System Speed Dial memories or 80 System Speed Dial memories that provide shared access by all stations. System Speed Dial memories may be set to override or not override code restriction assignments in groups of 10 or 100.

When 80 system speed dial buffers are allowed, each station user has an additional 20 station speed dial buffers.

SYSTEM AVAILABILITY

Terminal Type

All terminals.

Required Components

None.

OPERATING PROCEDURES

To program the System Speed Dial buffer from the Attendant Position:

1. Press **Feature**.
2. Press **Redial**.
3. Dial the Speed Dial buffer number to be programmed (use **0 0 ~ 7 9** or **0 0 0 ~ 9 9 9**).
4. Dial the Trunk or Trunk Group Access Code (maximum four digits).
5. Dial the desired telephone number.
6. Press **Hold**, and enter the name using the character codes (optional step). Refer to Section S-11 Speed Dial Stored Characters.
7. Press **Feature**.

To use System Speed Dial from a Multiline Terminal:

1. Press **Redial**.
2. Dial the System Speed Dial buffer number (use **0 0 ~ 7 9** or **0 0 0 ~ 9 9 9**).

To use a Feature Access or One-Touch key programmed for System Speed Dial from a Multiline Terminal:

1. Press the desired Feature Access or One-Touch key.

To use a System Speed Dial buffer from a Single Line Telephone:

1. Lift the handset, and receive internal dial tone.
2. Dial the Speed Dial Access Code (default: *).
3. Dial the System Speed Dial buffer number (use 0 0 ~ 7 9 or 0 0 0 ~ 9 9 9).
4. Talk with called party.

SERVICE CONDITIONS

Data Assignment

- Class of Service assignment allows station users to program System Speed Dial buffers.
- The 80 or 1000 System Speed Dial mode is Assigned in System Programming.
- In System Programming, System Speed Dial access is allowed or denied per tenant/per System Speed Dial block assignment. Using 80 System Speed Dial mode, blocks have groups of 10 buffers. When using 1000 System Speed Dial mode, the blocks are divided by groups of 100 buffers.
- When using 1000 System Speed Dial mode, buffers 900~999 cannot be restricted from any tenant.
- System Speed Dial blocks can be shared by one or more tenants.
- In System Programming, System Speed Dial can be assigned to override Code Restriction per Code Restriction Class.

General



- One thousand System Speed Dial buffers (000~999) are available when no Station Speed Dial buffers are assigned.
- A maximum of 24 digits can be programmed into a System Speed Dial buffer.
- A name can be entered with the number to be dialled when programming a System Speed Dial buffer. The name is displayed when the Speed Dial buffer is used.
- A maximum of 13 characters using 80 System Speed Dial mode or 12 characters using 1000 System Speed Dial mode can be entered for the name.





- ④ A pause, hookflash, *, and # may be programmed into a System Speed Dial buffer. Each item is counted as a digit, except the Trunk and Trunk Group Access Code.
- ④ The built-in battery backup on the CPUI()-U() ETU retains System Speed Dial memories if power fails.
- ④ To verify System Speed Dial buffer contents, press the Conference key, then the Redial key, and then dial the System Speed Dial buffer (use 00~79 or 000~999) on a Multiline Terminal with an LCD display.
- ④ Multiline Terminal users may access two or more System Speed Dial buffers by using the Consecutive Speed Dial feature.
- ④ A pause is automatically inserted if a PBX Access Code with a pause is entered into a System Speed Dial buffer. (Must be allowed in System Programming.)
- ④ Pauses should not be stored in Speed Dial in systems with the Least Cost Routing (LCR) feature. These pauses may cause the MIFM-U() ETU with KMM()UA to seize a Least Cost Route because the pauses may be considered digits dialled. In systems using the LCR feature, pauses should be programmed as part of extra codes in the Extra Code Add Table.

RELATED FEATURES LIST

Feature Number	Feature Name
C-23	Consecutive Speed Dial
F-1	Feature Access – User Programmable
N-1	Nesting Dial
S-10	Speed Dial – Station

GUIDE TO FEATURE PROGRAMMING

Order and Shortcut	System Data Name	Memory Block	Function	1-8-07 Attendant Page-Line Key	1-8-08 Station Page-Line Key
 +BE	Speed Dial Buffer Allocation	1-1-35			
 +BE	Speed Dial Number/Name Display Selection	1-1-33			
 +AC	System Speed Dial Restriction by Tenant	1-1-18			

Order and Shortcut	System Data Name	Memory Block	Function	1-8-07 Attendant Page-Line Key	1-8-08 Station Page-Line Key
 +BTS	Class of Service (Attendant) Feature Selection 1	1-8-07		1-3	
 +BTT	Station to Class of Service Feature Assignment	4-17			
 +AC	System Speed Dial Override by Class Selection	1-1-62			
 +BN	System Speed Dial Display Assignment	2-07			
 +BA	Access Code (1-, 2-, or 3-Digit) Assignment	1-1-46/47/ 48	090, 095		

Station Camp-On

S-13

FEATURE DESCRIPTION

The Station Camp-On feature allows a call to be transferred to a busy station. When the station receiving the camp-on tone becomes idle, the call rings and can be answered. After a programmed time interval, unanswered camp-on calls recall to the station that initiated the camp-on.

SYSTEM AVAILABILITY

Terminal Type

All terminals.

Required Components

None.

OPERATING PROCEDURES

To originate Station Camp-On from a Multiline Terminal with a call in progress:

1. Press **Transfer**; call is placed on Non-Exclusive Hold.
2. Dial the station number or press the designated DSS key programmed on a Flexible Line key or One-Touch key on the terminal. Receive call waiting tone.
3. Go on-hook.
4. After timeout, if the Camp-On remains unanswered, the line recalls, and the LED on the assigned CO/PBX line key returns to flashing green.
5. Press the CO/PBX line key with green LED, and go off-hook to return to the call.

To answer a Camp-On while engaged in a call:

1. Receive a camp-on tone. CO/PBX line key LED flashes green.
2. Press the flashing **Answer**. The existing CO/PBX line call is automatically placed on hold, and the camp-on is answered.
3. Go on-hook. Transferred call rings.
4. Go off-hook or press **Answer**, and talk with the incoming caller.

To originate a Station Camp-On from a Single Line Telephone with a call in progress:

1. Press the hookswitch momentarily, and receive second dial tone.
2. Dial the station number to where call is to be transferred.
3. Hang up.

**SERVICE
CONDITIONS****General**

- ④ If the Camp-On is placed after Tone Override, camp-on tone is provided.
- ④ Station and Attendant Camp-On Recall timers can be assigned separately.
- ④ Camp-On Tone receive is assigned in Station Class of Service assignment.

Station Hunting

S-14

FEATURE DESCRIPTION

The Station Hunting feature distributes internal and outside calls to multiple stations in a Station Hunt group. When a station number programmed as a Station Hunting master number is dialled, and this number is busy, the call is forwarded to another station in that hunt group.

SYSTEM AVAILABILITY

Terminal Type

All terminals.

Required Components

None.

OPERATING PROCEDURES

To call a Station Hunt group from an internal station:

1. Lift the handset, and receive internal dial tone.
2. Dial the station number of the desired hunt group.
3. Talk with the called party when answered.

To use this feature for an incoming internal, DIT/ANA, or Tie/DID call:

1. Incoming call to station number programmed as a Station Hunting master number.
2. The first available station in the hunt group receives the call.

SERVICE CONDITIONS

Data Assignment

- ④ Any station can be assigned as a Station Hunting master number.

Restrictions

- ④ When all stations in the desired hunt group are busy, the transferring caller hears call waiting tone when transferring the call to this hunt group. The call is camped on the Station Hunting master number and does not forward to other stations in the group when they become idle.

General





- ④ A maximum of 120 stations in the Xen IPK Expanded system or 32 in the Xen IPK Basic system, can be assigned to a hunt group.
- ④ The station master number is an actual station. If this station is busy, the call is forwarded to the next programmed answering station.
- ④ Linear hunt (consecutively search from the lead station) is provided.
- ④ DIT/ANA calls to Station Hunting master numbers follow the station hunt group assignment.
- ④ When a station number other than the Station Hunting master number in the hunt group is dialled directly, hunting is not performed.
- ④ When a Station Hunting master number is set for Call Forward - All Calls/Busy, incoming calls to this station follow the Call Forward setting. If the Forward to Station is busy, the incoming calls follow the station hunting assignment.
- ④ A Station Hunting master number can be included in another station hunting group to chain together two Station Hunting groups.
- ④ The following conditions cause a station in the hunt group to be skipped:
 1. The station is busy.
 2. Call Forward - All Calls is set for that station.
 3. The station is in DND Mode.
 4. The station is off-line.
- ④ CO Ring transfers, DIT/ANA, Tie/DID, and internal calls to a Station Hunting master number do not hunt past an unanswered member of the hunt group.

RELATED FEATURES LIST

Station Message Detail Recording (SMDR)

Feature Number	Feature Name
S-5	Simplified Call Distribution

GUIDE TO FEATURE PROGRAMMING

Order and Shortcut	System Data Name	Memory Block	Function	1-8-07 Attendant Page-Line Key	1-8-08 Station Page-Line Key
 +BTT	* Intercom Master Hunt Number Selection	4-14			
 +BTT	* Intercom Master Hunt Number Forward Assignment	4-15			
 +AA	SCD (Simplified Call Distribution) Pilot Number Assignment	1-8-29			
 +AA	SCD Group Agent Assignment	1-8-30			

* When the system is at default this Memory Block **must** be programmed for the feature to be used.

THIS PAGE INTENTIONALLY LEFT BLANK

Station Message Detail Recording (SMDR)

S-15

FEATURE DESCRIPTION

An optional MIFM-U() ETU provides detailed outside call records of system telephone usage. This supports cost control by identifying telephone users, trunk usage, and digits dialed. SMDR enables connection of call accounting equipment to audit local and long distance telephone bills.

SYSTEM AVAILABILITY

Terminal Type

All terminals:

1. Incoming CO/PBX Call
2. Outgoing CO/PBX Call
3. Conference CO/PBX Call
4. Transferred CO/PBX Call

Required Components

RS-232C compatible printer and RS-232C straight connection cable and/or a call-accounting unit must be locally provided.

MIFM-U() ETU

OPERATING PROCEDURES

Not applicable.

SERVICE CONDITIONS

Data Assignment

- ☎ SMDR can be assigned to output incoming calls, outgoing calls, or All Calls in System Programming.
- ☎ Printout is selectable in 1-line or 2-line format in System Programming.
- ☎ System Programming allows user to block the last four digits of a telephone number that was called.
- ☎ Incoming transfer or conference calls and outgoing calls are not output through SMDR until the SMDR Valid Call Timer has elapsed. The Valid Call Timer can be programmed in System Programming.
- ☎ Individual terminals can be assigned to produce SMDR records.

Restrictions

- ☎ Call records are not provided for internal calls.
- ☎ Caller ID name is not printed on SMDR.

General

- ④ If the printer or other I/O devices fail to operate, approximately 100 call records are saved in the MIFM-U() ETU buffer. When the buffer becomes full, the first call record is lost and the last call record is stored.
- ④ Call record data provides the following information:
Start Time, Trunk Number, Trunk Group, Type of Call, Station Number, Duration, Number Dialed, LCR, Calling Station Number, and Transferred Station Number.
- ④ The maximum number of digits allowed for output of telephone number is 24.
- ④ When printer or PC onnected is assigned in System Programming, and a printer or PC is not connected to the system, a PRINTER TROUBLE LCD indication and an audible alert tone occur at the first two Multiline Terminals connected to the system (Stations 100 and 101). If an MIFM-U() ETU is not installed or disabled, no alarm indication is given.
- ④ When the Caller ID feature is installed, SMDR prints the incoming caller telephone number when received from the Central Office.
- ④ An SMDR call Record will be generated where a station assigned to not print SMDR records transfers a call to a station, which is assigned to print SMDR records.

SMDR Print Formats

④ Outgoing Call

<u>07/03/98</u>	<u>09:00</u>	<u>08-05-12</u>	<u>OG</u>	<u>123</u>	<u>00</u>
A	B	C	D	E1	E2
<u>00:15:32</u>	<u>102885167537000</u>				
G	H				

④ Outgoing Call (LCR)

<u>07/03/98</u>	<u>09:00</u>	<u>08-05-12</u>	<u>OG</u>	<u>123</u>	<u>00</u>
A	B	C	D	E1	E2
<u>00:15:32</u>	<u>102885167537000</u>				
G	H				

④ _____ LCR

④ _____ K

④ Incoming Call

<u>07/03/98</u>	<u>09:00</u>	<u>05-12</u>	<u>IC</u>	<u>123</u>	<u>00</u>
A	B	C	D	E1	E2
<u>00:15:32</u>	<u>9727517622</u>				
G	H				

- DISA (Both incoming and outgoing are printed). Format shown is printed if incoming caller hangs up first. Format is reversed if called party hangs up first.

```

07/03/98      09:00      05-12      IC      999234
      A          B          C          D          EF
00:15:32
      G
    
```

- _____ D100
- J







```

07/03/98      09:00      08-05-12      OG      999      00
      A          B          C          D          E1      E2
00:15:32      102885167537000
      G          H
1234567890      D100
      I          J
    
```

E2 is in PC mode only, the rest are printed in Printer and PC mode.

SMDR Format Explanation
A~K are printout items.





- A Start Date
 07 = month
 03 = day
 98 = year
- B Start Time
 09 = hour
 00 = minute
- C Trunk Information
 08 = Route Advance Block
 05 = Trunk Group
 12 = Trunk Number
- D Call Type
 IC Incoming Call
 OG Outgoing Call
 ICC Conference on Incoming Call
 OGCConference on Outgoing Call
 IT Transferred Incoming Call
 OT Transferred Outgoing Call
 ITC Conference on Transferred Incoming Call
 OTC Conference on Transferred Outgoing Call
- E1 Station Number or ID Number
 1 2-digit Station Number in System Programming
 2 3-digit Station Number in System Programming
 3 4-digit Station Number in System Programming
- E2 Tenant number station belongs to (PC mode only) 00~47

-  **F** Transferred Station Number
 22-digit Station Number in System Programming
 33-digit Station Number in System Programming
 44-digit Station Number in System Programming
-  **G** Call Duration
 00 = hour
 15 = minutes
 32 = seconds
-  **H** Number Dialed
 Maximum of 24 Characters
 Incoming Caller ID Number = 9727517622
-  **I** Account Code Entry:1234567890
 Maximum of 16 Characters
 Forced Account Code: A1234567890
 Maximum of 13 Characters
 If both are entered, SMDR prints the Account Code entry followed by the Forced Account Code
-  **J** Station Number of DISA Caller
 Maximum of 4 Characters
-  **K** Least Cost Routing







RELATED FEATURES LIST

Feature Number	Feature Name
A-1	Account Code Entry
A-2	Account Code - Forced/Unverified

GUIDE TO FEATURE PROGRAMMING

Order and Shortcut	System Data Name	Memory Block	Function	1-8-07 Attendant Page-Line Key	1-8-08 Station Page-Line Key
 +BS	Card Interface Slot Assignment	7-1			
 +BS	MIF (SMDR) Assignment	7-3-02			
 +BS	MIF (LCR) Assignment	7-3-01			
 +AS	* Printer Connected Selection	1-5-13			
 +AS	Printer Line Feed Control Selection	1-5-14			

Doc. No. 8201 - Release 1.0
July 2003

Order and Shortcut	System Data Name	Memory Block	Function	1-8-07 Attendant Page-Line Key	1-8-08 Station Page-Line Key
 +AS	SMDR Incoming/Outgoing Print Selection	1-5-26			
 +AS	SMDR Valid Call Time Assignment	1-5-25			
 +AS	SMDR Print Format	1-5-02			
 +CSS	COM Port Baud Rate Setting Assignment	1-8-35			
 +BM	Start Time Selection	1-1-05			
 +AS	SMDR Telephone Print Selection	4-56			

* When the system is at default this Memory Block **must** be programmed for the feature to be used.

THIS PAGE INTENTIONALLY LEFT BLANK

Station Name/Number Display

S-16

FEATURE DESCRIPTION

This feature allows a Multiline Telephone to display on its LCD its name and/or station number. These are displayed while the telephone is idle.

SYSTEM AVAILABILITY

Terminal Type

All Multiline Terminals with an LCD.

Required Components

None.

OPERATING PROCEDURES

Data Assignment

- ④ Use Memory Block 4-61 (Extension Name/Number Display Selection) to specify the type of information to be displayed on an idle multiline telephones LCD,
 - None,
 - Number only,
 - Name only, or
 - Name and Number.
- ④ Use Memory Block 4-10 (Station Number Assignment) to specify a station's extension number. This may be 2, 3 or 4 digits long.
- ④ Use Memory Block 4-18 (Station Name Assignment) to specify a station's name. This may be up to 6 characters long.

General

- ④ An idle multiline telephone's LCD displays information in the following priority order.
 1. LCR and related trouble
 2. Printer trouble
 3. System data registration in progress
 4. Absent message
 5. Call Back indication
 6. Station number/name display in idle state

- ④ The station number and/or name is positioned to the left side of the LCD. When both number and name are to be displayed, space(s) are provided between the number and name. Examples of these are indicated below:

Number only:	100
Name only:	NAME
Number and Name:	
2 digit Station No.:	10 NAME
3 digit Station No.:	100 NAME
4 digit Station No.:	1000 NAME

RELATED FEATURES LIST

Feature Number	Feature Name
A-6	Alphanumeric Display

Station Outgoing Lockout

S-17

FEATURE DESCRIPTION

This feature allows a station user to temporarily restrict outgoing calls by assigning a personal code (password).

SYSTEM AVAILABILITY

Terminal Type

All terminals.

Required Components

None.

OPERATING PROCEDURES

To set:

1. Go off-hook; receive internal dial tone.
2. Dial Password set Access Code. (Not set at default.)
3. Dial the Password Code 0 0 0 0 0 0 0 0 0 0 (set as default).
4. Receive confirmation tone, and hang up.

To cancel:

1. Go off-hook; receive internal dial tone.
2. Dial Password cancel Access Code. (Not set at default.)
3. Dial the Password Code 0 0 0 0 0 0 0 0 0 0 (set as default).
4. Receive confirmation tone, and hang up.

To cancel Telephone Password and Default Password from the Attendant Position:

1. Go off-hook; receive internal dial tone.
2. Dial Password cancel Access Code from another station. (Not set at default).
3. Dial the station number.
4. Receive confirmation tone, and hang up.

To change the Password Code

1. Go off-hook; receive internal dial tone.
2. Dial Password change Access Code. (Not set at default).
3. Dial current Password Code.
4. Enter new Password Code.
5. Hang up.

SERVICE CONDITIONS

Data Assignment

- ☎ Telephone Password can be allowed or disallowed by Station Class of Service.
- ☎ The ability to cancel Telephone Password and default a station password is allowed or disallowed by Attendant Class of Service.
- ☎ At default, when a station user sets Telephone Password, the station is outgoing restricted. This can be changed (system-wide) to a different Code Restriction Class of Service in System Programming.





General

- ☎ Internal calls, Paging, and Feature Access are still provided when a telephone is locked out.
- ☎ The Password can be a maximum of 10 digits.
- ☎ Password Set/Cancel and Password Change do not have an Access Code at default.
- ☎ Service tone is not provided when setting a new password that is less than 10 digits.
- ☎ There is no terminal indication when Station Outgoing Lockout is set.

RELATED FEATURES LIST

Feature Number	Feature Name
C-19	Code Restriction

GUIDE TO FEATURE PROGRAMMING

Order and Shortcut	System Data Name	Memory Block	Function	1-8-07 Attendant Page-Line Key	1-8-08 Station Page-Line Key
 +BTS	Class of Service (Attendant) Feature Selection 1	1-8-07		2-4	
 +BTS	Class of Service (Station) Feature Selection 2	1-8-08			2-3
 +BTT	Station to Class of Service Feature Assignment	4-17			
 +BA	* Access Code (1-, 2-, or 3-Digit) Assignment	1-1-46/47/ 48	035 ~ 038		
 +AC	Code Restriction Class Assignment when Lockout is Set	1-1-70			

* When the system is at default this Memory Block **must** be programmed for the feature to be used.

THIS PAGE INTENTIONALLY LEFT BLANK

Station Relocation

S-18

FEATURE DESCRIPTION

The Station Relocation feature enables a station to be moved from one location to another without reprogramming the station data. The station set of features and extension numbers is the same after it has been moved to the new location.

SYSTEM AVAILABILITY

Terminal Type

All terminals.

Required Components

None.

OPERATING PROCEDURES

To set and cancel the Terminal Exchange Mode (Attendant)

1. Press **Feature**.
2. Dial Access Code **8** **4**.

To exchange two terminals

1. Press **Speaker**.
2. Dial the Terminal Exchange Access Code _____ (not assigned at default).
3. Dial the extension number of the distant Multiline Terminal (*i.e.*, the new Multiline Terminal).
4. Enter the telephone password of the distant Multiline Terminal (same password set for Station Lockout).
5. Press **Speaker**. The Multiline Terminal is relocated.

SERVICE CONDITIONS

Data Assignment

- Any Attendant can turn the feature ON and OFF, if allowed in Attendant Class of Service.

Restrictions

- ④ This feature can be used to relocate terminals among the following combinations:

MultilineMultiline

Single Line TelephoneSingle Line Telephone

Single Line Telephone AdapterSingle Line Telephone Adapter

- ④ This feature cannot be used with the following combinations:

MultilineSingle Line Telephone

MultilineSingle Line Telephone Adapter

Single Line TelephoneSingle Line Telephone Adapter

- ④ An error tone is received and Error is displayed in the LCD under the following conditions:





- Entering a station number that causes a prohibited combination (refer to the previous bullet for combinations).
- Entering a station number that does not exist.
- Entering the station number of the terminal being used to perform Station Relocation.
- Entering a Pilot Number or CAR number.
- Entering the wrong password.
- Entering a station number of the terminal to be exchanged and that station is not idle.
- Station Relocation Mode is not set.

General

- ④ The station password must be set from an individual station.
- ④ The station password is the same as the password set for Station Lockout.
- ④ If Feature + 84 is programmed on a One-Touch key or Feature Access key, the LED lights when this feature is turned ON and remains lit until the feature is turned OFF. Feature + 84 is used to toggle this feature ON and OFF.
- ④ When this feature is set/reset using Feature + 84, the setting is retained even if a second power on is performed. The BLF indication on the One-Touch or Feature Access keys returns when the system becomes operable.
- ④ If multiple Attendants have Feature + 84 stored on a One-Touch or Feature Access key, they have the same BLF indications on the key where Feature + 84 is stored.
- ④ When this feature is set/reset using Feature + 84, RELO Mode ON or RELO Mode OFF is displayed for five seconds.

- ⓘ This feature cannot be used to relocate DSS Consoles because consoles are not assigned station numbers. If Station Relocation is performed for a station that has an associated DSS Console, the station is relocated but not the DSS Console.

GUIDE TO FEATURE PROGRAMMING

Order and Shortcut	System Data Name	Memory Block	Function	1-8-07 Attendant Page-Line Key	1-8-08 Station Page-Line Key
 +BTS	Class of Service (Attendant) Feature Selection 1	1-8-07		3-1	
 +BTS	Class of Service (Station) Feature Selection 2	1-8-08			5-3
 +BTT	Station to Class of Service Feature Assignment	4-17			
 +BA	* Access Code (1-, 2-, or 3-Digit) Assignment	1-1-46/47/ 48	148		

- * When the system is at default this Memory Block **must** be programmed for the feature to be used.

THIS PAGE INTENTIONALLY LEFT BLANK

Station Transfer

S-19

FEATURE DESCRIPTION

The Station Transfer feature allows any station user in the system to transfer any call to any other station. Outside calls can be transferred to Multiline Terminals without the direct line appearance. To initiate Call Transfer, press the Transfer key on a Multiline Terminal or use the hookswitch on a Single Line Telephone. The transfer is completed by going on-hook on a Multiline Terminal or Single Line Telephone.

SYSTEM AVAILABILITY

Terminal Type
All terminals.

Required Components
None.

OPERATING PROCEDURES

To use this feature with a Multiline Terminal with a call in progress:

1. Press **Transfer**. Receive internal dial tone. The call is placed on Non-Exclusive Hold.
2. Dial the station number where the call is to be transferred.
3. Hang up.

To use this feature with a Single Line Telephone with a call in progress:

1. Provide hookflash. The call is put on Exclusive Hold. Receive internal dial tone.
2. Dial the station number of the station where call is to be transferred.
3. Hang up.

- OR -

When the party answers, announce the transfer.

4. Restore the handset (transfer is completed).

SERVICE CONDITIONS







Data Assignment

- ④ This feature can be disallowed in System Programming system-wide (default: transfer is allowed).
- ④ A recall timer for a transferred call can be programmed in System Programming. Any station with an Attendant Add-On Console assigned to it recalls using the Attendant Add-On Console Transfer/Camp-On Recall Timer. A station without an Attendant Add-On Console recalls using the Station Transfer Recall Timer.
- ④ CO Transfer Ring Pattern and Ring Tone can be assigned in System Programming.
- ④ Use Memory Block 4-66 (MOH or Ring Back Tone Selection) to assign MOH or Ring Back Tone for the outside party when a trunk call is placed on hold by the Transfer key on a Dterm, or hook flash from a Single Line Telephone, or the Transfer or Hold keys at a PHS station.

General

- ④ After transferring an answered call, the Multiline Terminal user can enter a conference by pressing the Conference key on the Multiline Terminal even after the Transfer key is pressed.
- ④ After transferring an answered call, the Single Line Telephone user can enter a conference by providing a second hookflash.

GUIDE TO FEATURE PROGRAMMING

Order and Shortcut	System Data Name	Memory Block	Function	1-8-07 Attendant Page-Line Key	1-8-08 Station Page-Line Key
 +BTS	System Transfer/Camp-On Selection	1-1-11			
 +BM	System Transfer/Camp-On Recall Time Selection	1-1-12			
 +BCS	CO Transfer Ring Pattern Selection	1-1-13			
 +BCS	CO Transfer Ring Tone Selection	1-1-14			
 +BM	Attendant Add-on Console Transfer/Camp-on Recall Time Selection	1-1-64			
 +BTS	Class of Service (Station) Feature Selection 2	1-8-08			4-2
 +BTT	MOH or Ring Back Tone Selection	4-66			

FEATURE DESCRIPTION

If a caller receives a call waiting tone during an internal call, the caller can access the next higher station number in the same 10s group (e.g., 10~19, 20~29, or 110~119, 220~229) by dialing 2 (default).

SYSTEM AVAILABILITY

Terminal Type
All terminals.

Required Components
None.

OPERATING PROCEDURES

After calling a station and receiving a call waiting tone:

1. Dial $\textcircled{2}_{ABC}$ (set at default).
2. The next higher available station number is called.

After attempting to System Call Park call in a busy location and receiving busy tone (e.g., System Call Park locations 0 and 1 are busy, and an attempt is made to park in location 0):

1. Dial $\textcircled{1}$, and receive busy.
2. Dial $\textcircled{2}_{ABC}$; call is parked in park location 2.

SERVICE CONDITIONS

General

- \textcircled{f} Step Call operation can be performed only when a call waiting tone is heard.
- \textcircled{f} When a call is stepped to the next higher station number, the next available station number is accessed (it may not be the next consecutively numbered station).
- \textcircled{f} Step Call is provided in a 10s group (e.g., 100~109) of stations. If the highest station number in a 10s group is reached and is busy, the search continues with the lowest number in the group.
- \textcircled{f} This feature is unaffected by tenant assignment.

- ④ If Station 109 is call forwarded to Station 121, and Station 121 is busy, and a call is made to Station 109 which forwards to Station 121, a call waiting tone is received. If Step Call is used, the call skips to Station 122, if available.
- ④ When using the Step Call feature, the system skips stations that are busy.

GUIDE TO FEATURE PROGRAMMING

Order and Shortcut	System Data Name	Memory Block	Function	1-8-07 Attendant Page-Line Key	1-8-08 Station Page-Line Key
 +BA	Intercom Feature Access Code Assignment	1-2-24	002		

Store and Repeat

S-21

FEATURE DESCRIPTION

The Store and Repeat feature allows a Multiline Terminal user to store any telephone number in memory (while talking on a CO/PBX line) for later use.

SYSTEM AVAILABILITY

Terminal Type

All Multiline Terminals.

Required Components

None.

OPERATING PROCEDURES

To use this feature with a CO/PBX Call in progress (from a Multiline Terminal):

1. Press **Feature**.
2. Dial **7**.
3. Dial the desired number to be stored in memory.
4. Press **Feature**.
5. Restore the handset or press **Speaker**.

To repeat a stored number:

Multifunction (Dial Access)

1. Press **Redial**.
2. Dial *****.

Key Function

1. Go off-hook on a CO/PBX line; receive outside dial tone.
2. Press **Redial**.
3. Dial *****.

Restrictions

- ☎ Store and Repeat is valid only on outside line calls.

General

- ④ The Store and Repeat and the Save and Repeat features cannot be used simultaneously from a Multiline Terminal. The same memory area is shared by both features.
- ④ The stored number is retained in memory by the memory backup battery.
- ④ A new number can be saved over the last Store and Repeat number.
- ④ When entering a Store and Repeat number, the Conference key can be used to backspace and erase digits entered.
- ④ Press the Redial key to store pauses with a Store and Repeat number.
- ④ A hookflash cannot be saved in a Store and Repeat number.
- ④ A hookflash is sent to the CO/PBX line if you press the Recall key during Store and Repeat.

Stored Hookflash

S-22

FEATURE DESCRIPTION

The Stored Hookflash feature allows any Multiline Terminal user to store a hookflash in a Speed Dial buffer to allow one-step access to certain Centrex or PBX features.

SYSTEM AVAILABILITY

Terminal Type
All Multiline Terminals.

Required Components
None.

OPERATING PROCEDURES

To program a Hookflash in the Station Speed Dial buffer:

1. Press **[Feature]**.
2. Press **[Redial]**.
Enter buffer (80~99) followed by trunk access code.
3. Press **[Recall]** to enter a hookflash.
4. Press **[Feature]**.

To program a Hookflash in Feature Access key programmed for Speed Dial:

1. Press **[Feature]**.
2. Press **[Redial]**.
3. Press the Feature Access key.
4. Dial **[0]**.
5. Dial the Trunk or Trunk Group Access Code (maximum four digits).
6. Press **[Recall]** to enter a hookflash.
7. Dial the desired telephone number.
8. Press **[Hold]**, and enter name using the character codes (optional step).
9. Press **[Feature]**.

To program a Hookflash on a One-Touch key programmed for Speed Dial:

1. Press **Feature**.
2. Press **Redial**.
3. Press the One-Touch key.
4. Dial **0**.
5. Dial the Trunk or Trunk Group Access Code (maximum four digits).
6. Press **Recall** to enter a hookflash.
7. Dial the desired telephone number.
8. Press **Feature**.

To program a Hookflash in the System Speed Dial buffer (Attendant Position only):

1. Press **Feature**.
2. Press **Redial**.
3. Dial the System Speed Dial buffer number (**0 0** ~ **9 9** or **0 0 0** ~ **9 9 9**).
4. Dial the Trunk or Trunk Group Access Code (maximum four digits).
5. Press **Recall** to enter a hookflash.
6. Dial the desired telephone number.
7. Press **Hold**, and enter name using the character codes (optional step).
8. Press **Feature**.

To use the Speed Dial buffer with Stored Hookflash from a Multiline Terminal:

1. Press **Redial**.
2. Dial the Speed Dial buffer number (**0 0** ~ **9 9** or **0 0 0** ~ **9 9 9**).

To use Feature Access or a One-Touch key programmed for Station Speed Dial with Stored Hookflash from a Multiline Terminal

1. Press the desired Feature Access or One-Touch key.

SERVICE CONDITIONS



General

- ④ This feature is available to all Multiline Terminals.
- ④ Stored Hookflash is effective on Loop Start trunks when the system is installed behind a PBX or Centrex system.
- ④ A hookflash can be stored in System and Station Speed Dial buffers.
- ④ The LCD display for a Stored Hookflash shows / during programming and use of the Speed Dial buffer.
- ④ A Stored Hookflash can be used with a stored number.

For example:

A Station Speed Dial Key is stored as hookflash + 110. Pressing this particular key during an outside line conversation automatically becomes a centrex transfer.

GUIDE TO FEATURE PROGRAMMING

Order and Shortcut	System Data Name	Memory Block	Function	1-8-07 Attendant Page-Line Key	1-8-08 Station Page-Line Key
 +BCM	Hookflash Time Selection	1-1-02			
 +BCT	Trunk Type Selection	3-91			

THIS PAGE INTENTIONALLY LEFT BLANK

Synchronous Ringing

S-23

FEATURE DESCRIPTION

The Synchronous Ringing feature synchronises CO/PBX incoming ringing with the incoming ringing pattern from a Central Office.

SYSTEM AVAILABILITY

Terminal Type

All terminals except Single Line Telephones connected to AP(R)-R() Unit.

Required Components

None.

OPERATING PROCEDURES

Not applicable.

SERVICE CONDITIONS

- ⓘ Synchronous Ringing is programmed system-wide.
- ⓘ Synchronous Ringing is not supported for Tie/DID incoming calls, Off-Hook Ringing, or CO/PBX Ring Transfers.

RELATED FEATURES LIST

Feature Number	Feature Name
D-13	Delayed Ringing

GUIDE TO FEATURE PROGRAMMING

Order and Shortcut	System Data Name	Memory Block	Function	1-8-07 Attendant Page-Line Key	1-8-08 Station Page-Line Key
 +BCS	Synchronous Ringing Selection	1-1-59			

THIS PAGE INTENTIONALLY LEFT BLANK

System Data Up/Down Load

S-24

FEATURE DESCRIPTION

The System Data Up/Down Load feature, included with the NEC Maintenance Access Terminal (MAT) Software, transfers Station Speed Dial data, System Speed Dial data, and all System Data from/to a Pentium¹-compatible PC. System Data Up/Down Load can be performed from a local or remote location.

SYSTEM AVAILABILITY

Terminal Type
Not applicable.

Required Components

Local Access:

- ④ External Modem:
 - MIFM-U() ETU
 - 3.5"/5.25" floppy disk with MAT PC programming software
 - Straight DB-9 RS-232 cable
 - Null modem adapter cable (required for a direct connection between MIF ETU and a modem)
- ④ Internal Modem:
 - MIFM-U() ETU
 - MDM-U() Unit (to be mounted on the MIFM-U() ETU)
- ④ Remote Access:
 - An MIF modem unit local with an MNP class 5 modem at the remote site
 - MNP² Class 5 compatible modem at both sites
 - Pentium PC running Windows 95 or later.

OPERATING PROCEDURE

To up/down load system data:

1. Access the MIFM-U() ETU via a direct connection from a compatible PC, or use an MPN Class 5 compatible modem from a remote location through an outside line.
2. Select menu for Up/Down Load (communication menu).
3. Select the item (e.g., Speed Dial) to be transferred.

1. Pentium is a registered trademark of Intel Corporation.
2. MNP is a registered trademark of Microcom, Inc.

SERVICE CONDITIONS

- ④ This feature allows System Data to be programmed from a PC connected to the system.
- ④ Items that can be transferred:
 1. Complete System Data
 2. Partial System Data
 - › All System Data Blocks
 - › Tenant Blocks (All/Tenant/Individual Tenant)
 - › Trunk Blocks (All Trunk/Individual Trunk)
 - › Terminal Blocks (All Terminal/Individual Terminal)
 - › Trunk Route Blocks
 3. System Speed Dial
 4. Station Speed Dial
 - › All Station Speed Dial
 - › Block Station Speed Dial
 - › Individual Station Speed Dial
 - › One-Touch DSS Speed Dial

- ④ Loading time (all data).

Operation	On-Site (9600 bps)	Remote Site (2400 bps)
UP LOAD	3~5 minute	5~10 minute
DOWN LOAD	3~5 minute	5~10 minute

- ④ The user should verify the system hardware configuration between the MAT Software and the system or download the complete assignment mode before up/down loading System Data.

GUIDE TO FEATURE PROGRAMMING

Order and Shortcut	System Data Name	Memory Block	Function	1-8-07 Attendant Page-Line Key	1-8-08 Station Page-Line Key
 +BS	Card interface Slot Assignment	7-1			

Tandem Switching of 4-Wire E&M Tie Lines

T-1

FEATURE DESCRIPTION

The Tandem Switching of 4-wire E&M Tie Lines feature allows connecting E&M Tie Lines to other trunks through the system without help or supervision from an internal station to allow distant-end system users to remotely access trunks. Pad control is provided on the TLI(2)-U() ETU by a programmable transmission pad to adjust to the line loss levels of the Tie line accessed.

SYSTEM AVAILABILITY

Terminal Type

All terminals.

Required Components

TLI(2)-U() ETU

OPERATING PROCEDURES

To use this feature:

Select an E&M Tie Line and dial a station number or Trunk Group Access Code and telephone number in the distant-end system.

- OR -

The distant-end system user selects an E&M Tie line (from the local system) and dials the applicable Trunk Access Code and the desired number or extension number in the local system.

SERVICE CONDITIONS

Data Assignment

- ④ The TLI(2)-U() ETU has an Internal Software pad control and an External Software pad control.

Internal Software pad control is applied during E&M Tie line (transmit and receive) connections.

External Software pad control applies to the following connections:

- E&M Tie Line to CO Trunk
- E&M Tie Line to E&M Tie Line
- CO Trunk to E&M Tie Line

Restrictions

- ④ The tandem connection is not monitored for Code Restriction or for LCR.







General

- ④ The Xen IPK Expanded system can handle a maximum of 32 simultaneous tandem calls.
- ④ The Xen IPK Basic system can handle a maximum of 8 simultaneous tandem calls.
- ④ After a tandem connection is completed, the trunks disconnect (restore to idle) when either party hangs up and a disconnect signal is received by the corresponding trunk or the Automatic Disconnect Timer (default: 60 minutes) elapses.
- ④ Tandem Switching of E&M Tie Lines can be accomplished through several Xen IPK systems.
- ④ The local Xen IPK system can be programmed to restrict individual station users access to specific E&M Tie Lines. Each station can be programmed to restrict the maximum number of digits dialled on an E&M Tie Line by assigning Code Restriction.
- ④ Access to outside lines by an E&M Tie Line user is recorded by SMDR on the system where the CO line is connected. The originating system may also record the station that accesses an E&M Tie Line call via its own SMDR.
- ④ Tandem connection can be allowed or denied per Trunk group for one or both directions.
- ④ Tie/DID lines can be assigned to add up to two digits and/or delete up to two digits per Trunk group as needed in System Programming.

RELATED FEATURES LIST

Feature Number	Feature Name
E-3	E&M Tie Lines (4-Wire)
U-2	Uniform Numbering Network

GUIDE TO FEATURE PROGRAMMING

Order and Shortcut	System Data Name	Memory Block	Function	1-8-07 Attendant Page-Line Key	1-8-08 Station Page-Line Key
 +BS	Card Interface Slot Assignment	7-1			
 +ALN	Tie Line Networking Tandem Connection Assignment	5-01			
 +BCT	Trunk Internal Transmit Pad Selection	3-29			
 +BCT	Trunk Internal Receive Pad Selection	3-30			
 +BCT	Trunk External Transmit Pad Selection	3-31			
 +BCT	Trunk External Receive Pad Selection	3-32			
 +AT	Tandem Transfer Automatic Disconnect Time Selection	1-4-00			

THIS PAGE INTENTIONALLY LEFT BLANK

Tenant Service

T-2

FEATURE DESCRIPTION

Tenant Service subdivides the system into a maximum of 48 Tenants that have outside line access.

SYSTEM AVAILABILITY

Terminal Type
Not applicable.

Required Components
None.

OPERATING PROCEDURES

Not applicable.

SERVICE CONDITIONS

General

- Multiple tenants can share outgoing lines.
- Outgoing calls and Add-On Conferences may be accessed between tenants.
- Internal calls may be made to different tenants.
- Tenant assignment applies to Multiline Terminals and Single Line Telephones.
- To pick up a call in another tenant, a Call Pickup - Other Tenant Access Code must be used.
- Day/Night Mode Switching can be set per tenant; however, Automatic Day/Night Mode Switching can only be set system-wide.
- System Speed Dial display indication on the LCD of a Multiline Terminal is assigned per tenant.











Restrictions

- The Barge-In feature cannot be accessed between tenants unless it is used for outside lines that are shared by the tenants.

RELATED FEATURES LIST

Feature Number	Feature Name
D-2	Delay Announcement

GUIDE TO FEATURE PROGRAMMING

Order and Shortcut	System Data Name	Memory Block	Function	1-8-07 Attendant Page-Line Key	1-8-08 Station Page-Line Key
 +BN	Trunk to Tenant Assignment	2-01			
 +BTT	Telephone to Tenant Assignment	4-09			
 +BN	Line Key Selection	2-05			
 +BN	Line Key Selection for Tenant Mode	2-06			
 +BN	System Speed Dial Display Assignment	2-07			
 +BN	ECR Relay to Tenant Assignment	2-08			
 +AU	Automated Attendant Message to Tenant Assignment	1-4-12			
 +ALN	DID Digit Conversion Table	1-1-22			
 +BN	DID Limit to Tenant Assignment	2-09			
 +BTM	Line Key Selection for Telephone Mode	4-12			

Three-Minute Reminder

T-3

FEATURE DESCRIPTION

This feature provides a reminder tone that is heard every three minutes by the Multiline Terminal user who originated or answered an outside call.

SYSTEM AVAILABILITY

Terminal Type
All Multiline Terminals.

Required Components
None.

OPERATING PROCEDURES

Not applicable:

SERVICE CONDITIONS

General

- ☎ The Three-Minute Reminder produces a tone every three minutes from the built-in speaker on the Multiline Terminal during incoming or outgoing trunk calls.
- ☎ The timer starts counting when the Elapsed Call Timer begins. The timer begins immediately when an incoming call is answered.
- ☎ The Three-Minute Reminder can be programmed as allowed or disallowed per Multiline Terminal.
- ☎ The Three-Minute Reminder is provided for Add-On Conference calls.
- ☎ The Three-Minute Reminder feature is not available for Single Line Telephones or for handsfree mode on a Multiline Terminal.

GUIDE TO FEATURE PROGRAMMING

Order and Shortcut	System Data Name	Memory Block	Function	1-8-07 Attendant Page-Line Key	1-8-08 Station Page-Line Key
 +BTM	* 3-Minute Alarm Selection	4-94			

* When the system is at default this Memory Block **must** be programmed for the feature to be used.

THIS PAGE INTENTIONALLY LEFT BLANK

Tone Override

T-4

FEATURE DESCRIPTION

Multiline Terminal users calling a busy station and receiving a call waiting tone can generate a Tone Override that is heard by the originator and busy station. Multiline Terminal users may answer the Override by placing the existing call on hold.

SYSTEM AVAILABILITY

Terminal Type

All terminals.

Required Components

None.

OPERATING PROCEDURES

After calling a station and receiving call waiting tone:

1. Dial Access Code * to send the Tone Override (as set at default).
2. Receive confirmation tone.
3. Wait for the receiving party to answer the Tone Override, and then talk with party.

To answer Tone Override:

1. Receive Tone Override.
2. Press Hold , and talk with the party.

SERVICE CONDITIONS

Data Assignment

- ☎ To send a Tone Override to another station is allowed or denied by Station Class of Service.
- ☎ To receive a Tone Override is allowed or denied by Station Class of Service.



Restrictions

- ④ Tone Override can be accomplished only after receiving a call waiting tone.
- ④ An attempt to Tone Override a Multiline Terminal may be denied for the following reasons:
 - The Multiline Terminal is set in the Do Not Disturb (DND) mode.
 - Auto Redial is activated.
 - During Station Programming.
 - The Multiline Terminal is denied the ability to receive a Tone Override.
 - Another station is already sending a Tone Override to this station.
 - Account Code Entry is activated.

General

- ④ One Tone Override at a time can be received at a Multiline Terminal. This Tone Override is heard over the handset and speaker (if the receiving party is off-hook with the handset).
- ④ If a Multiline Terminal is assigned for Data Line Security, a Tone Override is not heard over the handset; however, the Tone Override is sent and heard from the speaker when the Multiline Terminal user is off-hook with the handset.
- ④ Tone Override is allowed from a Single Line Telephone until the PBR times out (default: 10 seconds).
- ④ If Tone Override is used from a Dial Pulse Single Line Telephone, default Access Code * must be changed to a numerical digit.

GUIDE TO FEATURE PROGRAMMING

Order and Shortcut	System Data Name	Memory Block	Function	1-8-07 Attendant Page-Line Key	1-8-08 Station Page-Line Key
 +BTS	Class of Service (Station) Feature Selection 2	1-8-08			1-8, 3-3
 +BTT	Station to Class of Service Feature Assignment	4-17			
 +BTT	SLT Data Line Security Assignment	4-90			

Trunk Queuing

T-5

FEATURE DESCRIPTION

The Trunk Queuing feature allows a station user to increase call processing efficiency. When all outside lines or a selected line are busy, telephone users can queue onto the busy line. When a line becomes available, the system provides an internal incoming ring to the queuing station. If the line is no longer needed, before the line becomes available, the queue request is cancelled by dialling an Access Code. Each station can queue an outside line by selecting the specific trunk in the queue procedure. This feature allows a station user to set trunk queuing to the specified trunk, internal Trunk group, or Route Advance Block.

SYSTEM AVAILABILITY

Terminal Type



All terminals.

Required Components



None.

OPERATING PROCEDURES



To use this feature from a Multiline Telephone when all outside lines are busy:

1. Press the desired busy outside line key.
2. Receive busy tone.
3. Dial the Trunk Queuing Access Code (default:  ).
4. Restore the handset.

- OR -

Dial the Access Code for outside line.
5. Receive busy tone.
6. Dial the Trunk Queuing Access Code (default:  ).
7. Restore the handset.



To use this feature from a Single Line Telephone when all outside lines are busy:

1. Dial the Access Code for outside line.
2. Receive busy tone.
3. Dial the Trunk Queuing Access Code (default:  ).
4. Restore the handset.

To use this feature from a Multiline Terminal or a Single Line Telephone when an outside line becomes available:

1. Receive internal ringing tone.
2. Lift the handset or press .
3. Receive the outside dial tone.
4. Dial the desired number.



To cancel this feature from a Multiline Terminal or a Single Line Telephone:

1. Lift the handset or press .
2. Receive internal dial tone.
3. Dial the Trunk Queuing Cancel Access Code (default:  ).
4. Restore the handset.

**SERVICE
CONDITIONS****Restrictions**



-  Trunk Queuing cannot be set on an outgoing restricted line. If it is attempted, reorder tone is provided.

General

-  A station that has Trunk Queuing set is notified via internal ringing tone if the station is idle, and the queued outside line becomes free. Multiline Terminals with an LCD receive the message LINE IDLE when the outside line becomes free. The Multiline Terminal user goes off-hook to receive outside line dial tone.
-  Incoming ringing calls have priority over CO/PBX line queuing.
-  If two or more stations are queued to the same outside line, Trunk Group, or Route Advance Block, a ringing tone is sent to the Multiline Terminals in the order set, indicating that the queued outside line is now free.

- ④ If the queued outside line is not seized within the time specified in System Programming, the queuing is released (default: 10 seconds.)
- ④ If a station that has set Trunk Queuing sets another queue, the original Trunk Queue is cancelled.
- ④ If a station with a CO/PBX queue set is busy on a different call when the queued line becomes available, the outside line can be seized by another station. Trunk Queuing is still set until both the trunk and station are idle at the same time.
- ④ The station user that set an outside line queue can cancel it by dialling an Access Code.
- ④ When the station user places an outside call using LCR, Trunk Queuing cannot be set.
- ④ When Call Appearance keys are in use, Trunk Queuing cannot be set on the busy Call Appearance key.

GUIDE TO FEATURE PROGRAMMING

Order and Shortcut	System Data Name	Memory Block	Function	1-8-07 Attendant Page-Line Key	1-8-08 Station Page-Line Key
 +BTS	Class of Service (Station) Feature Selection 2	1-8-08			1-2
 +BTT	Station to Class of Service Feature Assignment	4-17			
 +BT	Trunk Queuing Timeout Selection	1-1-37			

THIS PAGE INTENTIONALLY LEFT BLANK

Trunk-to-Trunk Transfer

T-6

FEATURE DESCRIPTION

The Trunk-to-Trunk Transfer feature allows any station user to establish Trunk-to-Trunk Transfers between two CO/PBX (disconnect signal must be provided), ISDN, DID, and/or E&M Tie line calls.

SYSTEM AVAILABILITY

Terminal Type

All Multiline Terminals.

Required Components

None.

OPERATING PROCEDURES

On Multiline Terminals with an outside call in progress:

1. Press **Transfer**, and receive internal dial tone.
2. Dial the Trunk Access Code (either CO/PBX line, ISDN, DID, or E&M Tie line) for desired trunk or press outside line key appearance.
3. Press **Feature**.
4. Press **Transfer** to establish a Trunk-to-Trunk connection.
5. Hang up.

SERVICE CONDITIONS

Data Assignment

- ⓘ This feature can be allowed or denied per trunk.

Restrictions

- ⓘ Single Line Telephone cannot be used for Trunk-to-Trunk Transfer.





General

- ⓘ All lines used for Trunk-to-Trunk Transfers must be able to provide remote disconnect supervision.
- ⓘ A conference circuit is not required for a Trunk-to-Trunk Transfer.
- ⓘ Station users cannot reenter a Trunk-to-Trunk Transfer after the connection is established.
- ⓘ If a Trunk Transfer is established using Call Appearance Keys, they are free when the transfer occurs.

- ④ If a Trunk-to-Trunk Transfer is established using Call Appearance keys, they stay lit until the trunks are released.
- ④ When the system is operating in ID mode (Memory Block 1-5-23 = ID), to ensure Trunk to Trunk transfer calls indicate correctly in the SMDR records, you must apply one of the following:
 1. In MB 1-9-00, assign 999 to an unused ID number.
 2. In MB 1-4-04, enter one of the ID numbers you have assigned in MB1-9-00.

Note that if the Trunk Transfer is completed before the outgoing call is answered (or the call duration timer has started), the SMDR records will show the EXT or ID number assigned in MB 1-4-04, not the EXT or ID number of the station transferring the call.

GUIDE TO FEATURE PROGRAMMING

Order and Shortcut	System Data Name	Memory Block	Function	1-8-07 Attendant Page-Line Key	1-8-08 Station Page-Line Key
 +BCT	* Trunk-to-Trunk Transfer Yes/No Selection	3-04			
 +BTS	* Class of Service (Station) Feature Selection 2	1-8-08			3-5
 +BTT	Station to Class of Service Feature Assignment	4-17			
 +AT	Tandem Transfer Automatic Disconnect Time Selection	1-4-00			

* When the system is at default this Memory Block **must** be programmed for the feature to be used.

Two-Colour LEDs

T-7

FEATURE DESCRIPTION

Multiline Terminals have Two-Colour LEDs (green or red) for Flexible Line keys and the Large LED indications. The two colours indicate station status (red) or message status (green). Green is used to indicate I-Hold (Exclusive and Non-Exclusive), I-Use, and recall conditions. Other functions are indicated with a red LED. The Attendant Add-On Console is also provided with LEDs (green or red) for direct access to stations.

SYSTEM AVAILABILITY

Terminal Type

All Multiline Terminals and Attendant Add-On Consoles.

Required Components

None.

OPERATING PROCEDURES

Not applicable.

SERVICE CONDITIONS

- ④ Multiline Terminal Flexible Line keys and Large LEDs are two-colour LEDs (red or green).
- ④ Each of the 48 DSS keys on the Attendant Add-On Console has two individual LEDs (one red and one green). The remaining 12 Function keys have one red LED.
- ④ Each of the Function keys (Feature, Conf, Redial, Speaker, and Answer) located on every Multiline Terminal has a red LED.
- ④ Refer to the Xen IPK System Hardware Manual for more information.

THIS PAGE INTENTIONALLY LEFT BLANK

Uniform Call Distribution (UCD)

U-1

FEATURE DESCRIPTION

The Uniform Call Distribution (UCD) feature permits incoming DIT/ANA, DID/Tie, and CO ring transferred calls to terminate in a prearranged hunt group. Incoming calls are distributed based on *longest idle* time among all members of the UCD group. When an incoming DIT/ANA, DID call to a UCD group encounters all UCD stations busy or no-answer, the call is queued and the caller receives a Delay Announcement after a predetermined time interval.

SYSTEM AVAILABILITY

Terminal Type

All terminals.

Required Components

MIFA-U() ETU (without the KMA ()UA Unit fitted).

OPERATING PROCEDURES

Not applicable.

GENERAL DESCRIPTION

CALL PROCESSING

This section includes the following features:

Abandoned Call Search

Abandoned incoming calls are not connected to Agent positions. The system can recognize abandoned calls and remove them from queue on trunks that provide calling party disconnect supervision.

Call Distribution to Agents

Calls are automatically distributed among Agents in a UCD group based on *longest idle* time.

Call Transfer to UCD Group Queue

CO Trunk calls, that have terminated to either a normal station or a UCD Agent, can be transferred to a UCD group queue.

Night Service

When the UCD group is placed in Night Mode, the system can route all incoming UCD calls to one of the following Internal Station Number, Night Announcement, transfer to the Attendant, or Trunk-to-Trunk Transfer.

Overflow

Overflow Service allows calls, that have been holding in queue for more than a predetermined time, to be directed to an assigned station or Station Hunting group.

Queuing

All incoming calls destined for UCD groups are placed in queue when no Agent in the UCD group is available to handle the call. Queue is used to provide service in order of arrival (first in, first out).

Pilot Numbers

Pilot Numbers are programmed in the System Data according to the numbering plan in effect for the system. Pilot Numbers do not correspond to any line appearances, either physical or virtual, in the Xen IPK system. No hardware equipment is required to assign a Pilot number. A UCD Group Pilot number does not function if programmed in a Station Hunting group.

AGENT AND SUPERVISOR FUNCTION

This section includes the following features:

Assistance

This feature allows an Agent to call a Supervisor, in the UCD group for assistance. Activating this feature while on a UCD call, automatically places the current call on hold and places an assistance call to the Supervisor. This feature uses a Feature Access or One-Touch key.

Break Mode

This feature allows Agents to leave the UCD Mode without logging off. Break Mode is used for breaks from work (e.g., lunch or coffee breaks). This feature uses a DND key that is programmed on a Feature Access or One-Touch key. If DND, Call Forward - All Calls/Busy/No Answer was programmed before Log on, non-UCD calls follow the programmed function while in Break Mode.

Logon/Logoff

This feature allows an Agent to log on/log off the system. Operating statistics are collected for the Agents until they log off. This feature is activated by the Logon/Logoff key that is programmed on a Feature Access or One-Touch key on the Agent position.

Non-UCD Call

This feature allows Agents or Supervisors to receive calls directly from stations or Attendants and dial trunks (e.g., Tie line, DID, DIT).

Answer/Release - Headset

This feature allows an Agent using a headset to answer or release a UCD call. This feature uses the Headset On/Off key that is assigned on a line key in System Programming.

Control of Night Mode

This feature allows the Supervisor to activate Night Mode. This feature can be activated and deactivated by the Night Transfer key that is programmed on a Feature Access or One-Touch key on the Supervisor terminal.

Monitoring (Barge-In)

This feature allows the Supervisor to select an Agent position to monitor calls connected to that position. This feature is activated by key operation on the Supervisor terminal.

SERVICE CONDITIONS

General







- ④ The Xen IPK system must have an MIFA-U() ETU installed to provide the UCD feature. (Note: The KMA () UA Unit must not be fitted).
- ④ The following maximum assignments for programming UCD groups and Agents are:
 - Up to 32 Agents can be programmed per system.
 - Up to four UCD groups can be assigned per system.
 - Up to 32 Agents can be assigned to one UCD group.
- ④ The UCD group is assigned a Pilot number. Calls directed to the Pilot number are directed to Agents of that UCD group.
- ④ All trunks used for UCD incoming calls must provide a receiving remote disconnect signal to tabulate abandoned calls.
- ④ If the Agent in the UCD group where a call is terminated does not answer for a predetermined time, the call is transferred to another Agent in the UCD group.
- ④ If the Agents in the UCD group where a call is terminated are all busy, the call waits in a queue until an Agent is available. The caller receives a Delay Announcement and Music On Hold. Calls are answered first-in, first-out.
- ④ If the Agents, in the UCD group where a call is terminated are all busy for a predetermined time, the call can be transferred (overflowed) to an assigned station or Station Hunting group, but it cannot provide overflow from one UCD group to another UCD group. The overflow feature does not provide transfer to an outside trunk.
- ④ Overflow is performed only once.
- ④ When the overflow destination station is busy, calls continue searching the UCD group for an available agent.











- ④ When the overflow destination station is set for Call Forward to a UCD group, overflow does not occur.
- ④ No alert tone is provided if all Agents in the UCD group are busy.
- ④ UCD and ACD cannot be provided on the same system.
- ④ Any Agent in a UCD group can press the Logon/Logoff key on the Multiline Terminal to busy out the position. When Logoff is activated, the station receives calls directed to that station number (but not the UCD group number).
- ④ Agents can log off or enter Break Mode only when their station is idle.
- ④ An alert tone is provided for the Monitoring feature.
- ④ While an ACD agent is logged on, Call Forwarding set at this station does not function.

RELATED FEATURES LIST

Feature Number	Feature Name
D-2	Delay Announcement

GUIDE TO FEATURE PROGRAMMING

Order and Shortcut	System Data Name	Memory Block	Function	1-8-07 Attendant Page-Line Key	1-8-08 Station Page-Line Key
 +BS	Card Interface Slot Assignment	7-1			
 +BS	MIF (UCD) Assignment	7-3-03			
 +BA	* Access Code (1-, 2-, or 3-Digit) Assignment	1-1-46/47/48	031, 032, 040		
 +AA	* ACD/UCD Group Pilot Number Assignment	1-12-00			
 +AA	* ACD/UCD Group Agent Assignment	1-8-25			
 +BTS	Class of Service (Station) Feature Selection 2	1-8-08			1-4,1-5
 +BTT	Station to Class of Service Feature Assignment	4-17			

Order and Shortcut	System Data Name	Memory Block	Function	1-8-07 Attendant Page-Line Key	1-8-08 Station Page-Line Key
 +AA	ACD/UCD Group Overflow Destination Assignment	1-12-01			
 +AA	ACD/UCD Group Overflow Time Selection	1-12-02			
 +BCT	DIT Assignment	3-42			
 +BCT	ANA Assignment	3-43			
 +BTM	Line Key Selection for Telephone Mode	4-12			
 +BTM	Extension Line Key Ring Assignment (Day Mode)	4-37			
 +BTM	Extension Line Key Ring Assignment (Night Mode)	4-38			
 +BTS	Barge-In Alert Tone Assignment	1-1-76			
 +AA	ACD Hunt Time	1-8-40			
 +BM	Call Forward- No Answer Time Selection	1-2-22			

* When the system is at default this Memory Block **must** be programmed for the feature to be used.

THIS PAGE INTENTIONALLY LEFT BLANK

Uniform Numbering Network

U-2

FEATURE DESCRIPTION

This feature allows multiple or compatible systems to be connected in a network via Tie lines. Station users can access any station by dialling a system number and a station number (open numbering) or by dialling the station number only (closed numbering). If the calling and called systems are not directly connected by a single Tie line, several Tie lines may be accessed to route the call to the final destination. Each network system automatically extends the call to the next system in line until the final destination is reached.

SYSTEM AVAILABILITY

Terminal Type

All terminals.

Required Components

TLI(2)-U() to provide Tie Line trunks.

OPERATING PROCEDURES

To originate a call using the open numbering plan:

1. Lift the handset, and receive internal dial tone.
2. Dial the Tie Line Access Code.
3. Dial the distant system number.
4. Dial the station number.

To originate a call using the closed numbering plan:

1. Lift the handset, and receive internal dial tone.
2. Dial the station number of the remote party.

To answer a call:

1. Go off-hook at the ringing station.
2. Talk with calling party.

SERVICE CONDITIONS

Data Assignment

When a system other than the Xen IPK is being networked with a Xen IPK system and the numbering plans cannot be changed on the existing system, Tie lines in the Xen IPK system can be programmed to delete and add digits to meet the existing numbering scheme.

Restrictions

- ④ DID Full Digit Conversion cannot access the Uniform Numbering Network.









General

- ④ Attention should be given to the Uniform Numbering Network Access Code plan to avoid a loss of Access Codes and to prevent duplicating codes in the network.
- ④ The distant system number can be programmed as 2 or 3 digits.
- ④ The Xen IPK system has a maximum of 32 Trunk Group Access Codes that are shared by outgoing Tie lines, ISDN and CO/PBX lines.
- ④ When a call from/to the remote-end is made to a busy station in the Xen IPK system, the caller cannot set features such as Callback Message, Step Call, or Camp-On.
- ④ Uniform Numbering Network does not access the Least Cost Routing (LCR) feature in the Xen IPK system.
- ④ A maximum of 16 Numbering Blocks are available. This allows a maximum of 17 connected systems per Uniform Numbering Network.

RELATED FEATURES LIST

Feature Number	Feature Name
E-3	E&M Tie Lines (4-Wire)E&M Tie Lines (4-Wire)
F-3	Flexible Numbering Plan
T-1	Tandem Switching of 4-Wire E&M Tie Lines

GUIDE TO FEATURE PROGRAMMING

Order and Shortcut	System Data Name	Memory Block	Function	1-8-07 Attendant Page-Line Key	1-8-08 Station Page-Line Key
 +BA	* Access Code (1-, 2-, or 3-Digit) Assignment	1-1-46/47/48	401 ~ 416		
 +BS	Station Number Assignment	4-10			
 +BCT	Trunk (Installed, DP/DTMF) Selection	3-92			
 +BCT	Trunk-to-Trunk Group Assignment	3-03			
 +BCS	Route Advance Block Assignment	1-1-30			
 +BCS	* Networking Trunk Group/Route Advance Assignment	1-1-49			
 +BCS	* CO/PBX Outgoing Digit Add Assignment	1-1-50			
 +ALN	Tie Line Networking Tandem Connection Assignment	5-01			
 +ALN	Digit Add/Del for Tie Line Networking Assignment	5-00			

* When the system is at default this Memory Block **must** be programmed for the feature to be used.

THIS PAGE INTENTIONALLY LEFT BLANK

Universal Slots

U-3

FEATURE DESCRIPTION

The Xen IPK system, B64-U() KSU, has eight universal slots and up to three cabinets can be installed. The system uses the same KSU for the basic and expansion cabinets to support up to 24 Universal Slots.

SYSTEM AVAILABILITY

Terminal Type
Not applicable.

Required Components
None.

OPERATING PROCEDURES

Not applicable.

SERVICE CONDITIONS

General

- Two software packages (Basic Port Package and Expanded Port Package) are available for the Xen IPK system using the CPUI()-U() ETU. Refer to the following table for maximum system capacities for each software package.

Item	Basic Port Package	Expanded Port Package	Notes
Basic Terminals (Phones)	32	120	
Shared Call Arrival (CAR) Keys with Basic Terminals	24	112	
Dedicated Call Arrival (CAR) Keys	40	0	
Basic Terminals + Call Arrival (CAR) Keys	72	120	
Basic Trunks	16	64	
Universal Slot	24	24	
Shared MIF Slots with Universal Slots	2	2	
Dedicated MIF Slot	1	1	

- The Basic Port Package does not limit the number of slots. It only limits the number of ports.

- ④ An ESIB(8)-U() ETU with an ESIE(8)-U() ETU installed supports 16 Electronic Station Interface ports. This combination can be installed in any Interface Slot (1~8) of any Cabinet (1~3) without requiring adjacent slots to be vacant.
- ④ PRT(1)-U() ETUs can be installed in any Interface Slot (1~8) of any Cabinet (1~3), only requiring one adjacent slot to be vacant when the number of channels is more than 24.
- ④ PRT(1)-U() ETUs can be assigned in Memory Block 7-1 (Card Interface Slot Assignment) with the following configurations:
 - PRT4 (4 ports, 4 B channels)
 - PRT8 (8 ports, 8 B channels)
 - PRT12 (12 ports, 12 B channels)
 - PRT16 (16 ports, 16 B channels)
 - PRT20 (20 ports, 20 B channels)
 - PRT24 (24 ports, 24 B channels)
 - PRT28 (28 ports, 28 B channels)
 - PRT32 (32 ports, 30 B channels)
- ④ The following Memory Blocks are used to assign non-physical station ports and will reduce the maximum station port capacity:
 - 1-2-04 Call Arrival (CAR) Key Block Assignment
 - 1-2-21 PS Telephone Block Assignment
 - 1-2-32 IP Phone Block Assignment

- ④ The available interface cards and maximum capacities for Universal Slots with the Xen IPK system are shown in the following tables.

Station Interface Units	Description	Maximum Capacities		Notes
		Basic Port Package	Expanded Port Package	
ACD(8)-U() ETU	8-port ACD System	1	1	Note 1, 4, 6
CNF(8)-U() ETU	8-port Conference Unit	2	2	Note 1, 7, 8
ESI(8)-U() ETU	8-port Electronic Station Interface	4	15	Note 1
ESIB(8)-U() ETU	8-port Electronic Station Interface	4	15	Note 1
ESIB(8)-U() ETU with ESIE(8)-U() ETU	16-port Electronic Station Interface	2	7	Note 1
FMS(2)/(4)-U() ETU	2-or 4-port Digital Voice Mail System	1	1	Note 1~4
OPX(2)-U() ETU	2-port Off-Premise Extension Interface	6	22	Note 1, 2
SLI(4)-U() ETU	4-port Single Line Interface	6	22	Note 1
SLI(8)-U() ETU	8-port Single Line Interface	3	14	Note 1
VMS(2)/(4)-U() ETU	2-or 4-port Digital Voice Mail System	1	1	Note 1~4
VMS(8)-U() ETU	8-port Digital Voice Mail System	1	1	Note 1, 3, 4

NOTE 1: Calculating maximum capacities are based on the system having a minimum of 8 Electronic Station Interface (ESI) ports and 4 Trunk ports.

NOTE 2: When 2-port Station Interface ETUs are installed, the system uses 4 ports from its maximum port capacity.

NOTE 3: Only one FMS or VMS system can be installed in one Xen IPK system.

NOTE 4: In Memory Block 7-2 (Telephone Type Assignment), a maximum of 32 Digital Voice Mail ports are available.

NOTE 5: In Memory Block 7-1 (Card Interface Slot Assignment), the ACD(8)-U() ETU is assigned as “VMS 8” and “Digital VM” in Memory Block 7-2 (Telephone Type Assignment).

NOTE 6: In Memory Block 7-1 (Card Interface Slot Assignment), the CNF(8)-U() ETU is assigned as “SLI 8” and “VM (Yes)” in Memory Block 4-35 (Voice Mail/SLT Selection).

NOTE 7: In Memory Block 4-35 (Voice Mail/SLT Selection), a maximum of 16 analogue Voice Mail ports are available.

Trunk Interface Units	Description	Maximum Capacities		Notes
		Basic Port Package	Expanded Port Package	
BRT (4)-U() ETU	4-port ISDN Interface for 8 trunks	2	8	Note 1
COI(4)-U() ETU	4-port CO/PBX Line Interface	4	16	Note 1
COI(8)-U() ETU	8-port CO/PBX Line Interface	2	8	Note 1
DID (4)-U() ETU	4-port Direct Inward Dialling Interface	4	18	Note 1
IPT(4)-U() ETU	4-port Voice over Internet Protocol Trunk Interface	4	15	Note 1, 4
IPT(8)-U() ETU	8-port Voice over Internet Protocol Trunk Interface	2	7	Note 1
PRT(1)-U() ETU	ISDN-Primary Rate Trunk Interface	4	8	Note 1, 3~5
TLI (2)-U() ETU	2-port Tie Line Interface	4	16	Note 1, 2

NOTE 1: Calculating maximum capacities are based on the system having a minimum of 8 Electronic Station Interface (ESI) ports and 4 Trunk ports.

NOTE 2: When 2-port Trunk Interface ETUs are installed, the system uses four ports from its maximum port capacity.

NOTE 3: With the Basic Port Package, a maximum of four PRT(1)-U() ETUs can be installed. When four PRT ETUs are installed, up to four trunks each can be assigned.

NOTE 4: With the Xen IPK Expanded Port Package, a maximum of 14 of the following 4-port trunk-type interface ETUs can be installed:

- IPT(4)-U() ETU [installed as a COI/COID(4)-U() ETU]

Application Interface Units	Description	Maximum Capacities		Notes
		Basic Port Package	Expanded Port Package	
BSU(2)-U() ETU	2-Channel - Base Station Unit for PHS	3	8	
DPH(4)-U() ETU	4-Channel - Door Phone Interface Unit	1	1	
ECR-U() ETU	External Control Relay Unit	1	1	
MIFA-U() ETU	Multiple Interface Unit for UCD/ACD	1	1	Note 1, 3
MIFM-U() ETU	Multiple Interface Unit for Multifunction	1	1	Note 1, 2, 3
PBR()-U() ETU	4-Channel - Push Button Receiver Unit	1	1	
VRS(4)-U() ETU	4-Channel - Voice Recording Service Unit	2	2	

NOTE 1: The MIFM-U() or MIFA-U() ETU must be installed in the ISA slot, slot 1, or slot 2 of the first B64-U() KSU.

NOTE 2: The MIFM-U() ETU has an optional built-in modem that works only when the The MIFM-U() ETU is installed in slot 1 or slot 2 of the first B64-U() KSU.

NOTE 3: The MIFA-U() ETU (with KMA()UA installed) has an ACD-MIS output that works only when the MIFA-U() ETU is installed in the ISA slot. When ACD-MIS and remote MAT PC programming are required, install the MIFA-U() ETU in the ISA slot and the MIFM-U() ETU in slot S1 or slot S2 of the first B64-U() KSU.

 Refer to the Xen IPK System Hardware Manual for more information.

Restrictions

 KSU Power-Based ETU Quantity Limitations







The following charts indicate the maximum number of specific ETU combinations in each KSU that are restricted by power limitations of the KSU.

*NO. of ESI(8) ETUs	NO. of ESI Ports	Maximum NO. of ACD+/FMS/VMS/IPT/SLI/OPX or DID ETUs	Other ETUs
10	80	2	No Limitation
9	72	2	No Limitation
8	64	3	No Limitation
7	56	4	No Limitation
6	48	5	No Limitation
5	40	5	No Limitation
4	32	6	No Limitation
3	24	6	No Limitation
2	16	7	No Limitation
1	8	7	No Limitation

RELATED FEATURE LIST

Feature Number	Feature Name
C-3	Call Arrival Keys (CAR)
D-7	Digital Voice Mail
D-8	Direct Inward Dialling (DID)
D-16	Door/Monitor Telephone
E-3	E&M Tie Lines (4-Wire)
A-21	Automatic Call Distribution (ACD Plus)
E-6	External Zone Paging (Meet-Me)
G-1	General Purpose Relays
I-7	ISDN-BRI Trunk Connections
I-8	ISDN-PRI Trunk Connections
L-5	Loop Start Trunks
M-3	Multiline Conference Bridge
S-15	Station Message Detail Recording (SMDR)
V-1	Voice Mail Integration (Analogue)
V-3	Voice Over Internet Protocol (VoIP)

GUIDE TO FEATURE PROGRAMMING

Order and Shortcut	System Data Name	Memory Block	Function	1-8-07 Attendant Page-Line Key	1-8-08 Station Page-Line Key
 +BS	Card Interface Slot Assignment	7-1			
 +BS	Telephone Type Assignment	7-2			
 +BK	Call Arrival Key Block Assignment	1-2-04			
 +AP	PS Telephone Block Assignment	1-2-21			
 +AH	IP Phone Block Assignment	1-2-32			
 +BTI	Voice Mail/SLT Selection	4-35			

Unsupervised Conference

U-4

FEATURE DESCRIPTION

The Unsupervised Conference feature allows a Multiline Terminal user to exit an established conference call and leave the remaining parties to continue talking. This same user can then reenter the conference anytime.

SYSTEM AVAILABILITY

Terminal Type

All multiline terminals.

Required Components



None.

OPERATING PROCEDURES

To exit a conference:

1. Establish a conference call from a Multiline Terminal.
2. Press  (conferenced CO line keys turn red).
3. Multiline Terminal user now hears dial tone.

To reenter a conference:

1. Lift the handset or press .
2. Press .

SERVICE CONDITIONS

Data Assignment

- ⓘ When establishing an Unsupervised Conference call, a warning signal sounds every three minutes for the duration of the call. A telephone put in the DND Mode can still hear the warning sounds. This feature must be allowed in System Programming Memory Block 4-94 (3-Minute Alarm Selection).





Restrictions

- ⓘ Users can join only one Unsupervised Conference at a time.
- ⓘ The Unsupervised Conference feature is available only on Multiline Terminals.

General

- ④ A maximum of six conference calls (Add-On and Unsupervised) may be in progress at the same time.
- ④ Other stations cannot enter an Unsupervised Conference.
- ④ Other stations cannot be interrupted (Barge-In) while on an Unsupervised Conference call.
- ④ If the Tandem Transfer Automatic Disconnect Timer runs out of time, the system automatically disconnects any outside calls.
- ④ An alert tone is heard one minute before the Tandem Transfer Automatic Disconnect Timer disconnects the outside caller.
- ④ ICM hold, Live Recording, and Voice Over can not be used during an Unsupervised Conference.
- ④ If the CO provides disconnect when one outside party hangs up, the other outside party is disconnected.

GUIDE TO FEATURE PROGRAMMING

Order and Shortcut	System Data Name	Memory Block	Function	1-8-07 Attendant Page-Line Key	1-8-08 Station Page-Line Key
 +BTS	* Class of Service (Station) Feature Selection 2	1-8-08			4-8
 +BTT	Station to Class of Service Feature Assignment	4-17			
 +AT	Tandem Transfer Automatic Disconnect Time Selection	1-4-00			
 +AT	Tandem Transfer SMDR Print Extension Assignment	1-4-04			

* When the system is at default this Memory Block **must** be programmed for the feature to be used.

User Programming Ability

U-5

FEATURE DESCRIPTION

Station users can perform programming functions at their station. Two features programmable from a station are Station Speed Dial and Ringing Line Preference. With NEC Client Administration Terminal (CAT) End-User Software, many additional features can be programmed by the user.

SYSTEM AVAILABILITY

Terminal Type

All terminals.

Required Components

None.

OPERATING PROCEDURES

Refer to Related Features for Operating Procedures.

SERVICE CONDITIONS

- Ⓞ Multiline Terminals must be idle and on-hook when programming any operation.

RELATED FEATURES LIST

Feature Number	Feature Name
F-1	Feature Access – User Programmable
N-1	Nesting DialNesting Dial
R-7	Ringing Line PreferenceRinging Line Preference
S-11	Speed Dial Stored Characters
S-10	Speed Dial – Station

THIS PAGE INTENTIONALLY LEFT BLANK

Voice Mail Integration (Analogue)

V-1

FEATURE DESCRIPTION

The Voice Mail Integration feature provides the necessary interface between the Xen IPK system and a locally-provided Voice Mail system. When a station is forwarded to the Voice Mail system and a station user calls that forwarded station, the call goes directly to the individual personal mail box. If the Voice Mail system has the ability, a message can be sent to the station indicating a Voice Mail Message was received. The Xen IPK system can support a maximum of 16 ports for Voice Mail Integration. This feature is for analogue Voice Mail systems.

SYSTEM AVAILABILITY

Terminal Type

All terminals.

Required Components

SLI()-U() ETU

OPERATING PROCEDURES

To retrieve a message from a Multiline Terminal with or without a LCD (large LED flashing):

1. Lift the handset.
2. Call the Voice Mail system by dialling the Voice Mail station number to access your mailbox.
3. Follow the instructions given by the Voice Mail system when answered.

To retrieve a message from a Single Line Telephone (Message Wait LED on):

1. Lift the handset.
2. Call the Voice Mail system by dialling the Voice Mail station number to access your mailbox.
3. Follow the instructions given by the Voice Mail system when answered.

SERVICE CONDITIONS

Data Assignment

- ④ Each SLI()-U() ETU port can be assigned in System Programming to support Voice Mail. A maximum of two SLI(8)-U() ETUs or four SLI(4)-U() ETUs can be installed to support 16 Voice Mail ports.
- ④ SLI()-U() ETU ports assigned as voice mail cannot establish an Add-On Conference Call.
- ④ The Message Waiting Access Code for Voice Mail set/cancel can be assigned in System Programming.

General

- ④ Some Voice Mail systems cannot leave a message indication.
- ④ A call transferred from a Voice Mail port that is not answered in 3 minutes recalls to the Voice Mail port. No digits are sent.
- ④ If a station is programmed for Multiple Call Forward (e.g., 100 CFWD – 101 CFWD – VM Hunt Group) and an internal call is made to station 100, the caller receives the mailbox for station 100.
- ④ The AP(R)-U() Unit, or SLT(1)-U() ADP does not support Voice Mail Integration.
- ④ Set/cancel Voice Mail Message Waiting only from a Voice Mail port.
- ④ When a call is completed, a disconnect signal is sent to the Voice Mail port.
- ④ If required by locally provided Voice Mail systems, up to four digits can be sent before a station number to access a user mailbox.
- ④ The Large LED flashes red for message from Voice Mail or green for message from an Attendant.

RELATED FEATURES LIST

Feature Number	Feature Name
D-7	Digital Voice Mail
S-14	Station Hunting

GUIDE TO FEATURE PROGRAMMING

Order and Shortcut	System Data Name	Memory Block	Function	1-8-07 Attendant Page-Line Key	1-8-08 Station Page-Line Key
 +BTI	* Voice Mail/SLT Selection	4-35			
 +BTT	Intercom Master Hunt Number Selection	4-14			
 +BTT	Intercom Master Hunt Number Forward Assignment	4-15			
 +AV	Voice Mail Quick Transfer Master Hunt Number	1-8-26			
 +BA	Intercom Feature Access Code Assignment	1-2-24	007		
 +BTS	Class of Service (Station) Feature Selection 2	1-8-08			1-1, 2-5, 6-2
 +BTT	Station to Class of Service Feature Assignment	4-17			
 +BA	* Access Code (1-, 2-, or 3-Digit) Assignment	1-1-46/47/48	020 ~ 025, 030, 032~034, 140~143		
 +BCT	DIT Assignment	3-42			
 +BCT	ANA Assignment	3-43			
 +AV	Voice Mail Digit Add Assignment	1-3-07			
 +AV	Voice Mail DTMF Delay Time Selection	1-3-08			
 +AV	Voice Mail DTMF Duration/Interdigit Time Selection	1-3-10			
 +AV	Voice Mail Disconnect Time Selection	1-3-09			
 +BTI	Bounce Protect Time Selection	1-3-01			
 +BTI	Hookflash Start Time Selection	1-3-05			
 +BTI	Hookflash End Time Selection	1-3-06			

* When the system is at default this Memory Block **must** be programmed for the feature to be used.

THIS PAGE INTENTIONALLY LEFT BLANK

Voice Mail Message Key

V-2

FEATURE DESCRIPTION

The Voice Mail Message Key provides a visual indication as to the existence of new voice mail messages sent to a mailbox. This feature can be assigned on a Line Key (Feature Access key) or One Touch key and can be placed on any terminal or DSS Console, not necessarily the terminal for which the mailbox is assigned. Pressing the Voice Mail Message Key will access the voice mail system to retrieve the voice mail messages.

SYSTEM AVAILABILITY

Terminal Type

Multiline terminals only.





Required Components

FMS(2)/(4)-U() ETU

VMS(2)/(4)/(8)-U() ETU

OPERATING PROCEDURES

To program a Feature Access Key as a Voice Mail Message Key:

1. Press .
2. Press .
3. Press One-Touch/Feature Access key (For DSS Console press DSS key).
4. Press .
5. Dial station number or mailbox number.
6. Dial .

Using Voice Mail Message Key when a message has been recorded:

1. Press flashing Voice Mail Message Key.
2. Wait until Voice Mail answers (enter security code if enabled).
3. Listen to Voicemail messages.

Note: If multiple messages are stored, the Voice Mail Message Key will continue to flash red until all messages are played.

SERVICE CONDITIONS

Data Assignment

- ④ Use Memory Block 1-8-08 [Class of Service (Station) Feature Selection 2] Page 6 LK2 to allow (LED On) Voice Mail Message Notification.
- ④ Use Memory Block 1-8-26 (Voice Mail Quick Transfer Master Hunt Number) to assign the Voice Mail Pilot Number.
- ④ Use Memory Block 2-05 (Line Key Selection) to select Tenant-Wide or Telephone Mode line key assignment to each tenant.
- ④ Use Memory Block 2-06 (Line Key Selection for Tenant Mode) to assign Feature Access Key (Page 1 LK6) to applicable Tenants.
- ④ Use Memory Block 4-10 (Station Number Assignment) to assign station number to each telephone port number.
- ④ Use Memory Block 4-12 (Line Key Selection for Telephone Mode) to assign Feature Access Key (Page 1 LK6) to applicable telephone port number.
- ④ Use Memory Block 4-14 (Intercom Master Hunt Number Selection) to assign Master Hunt Number for the voice mail telephone port number.
- ④ Use Memory Block 4-15 (Intercom Master Hunt Number Forward Assignment) to place voice mail port numbers in a hunt group.
- ④ Use Memory Block 4-17 (Station to Class of Service Feature Assignment) to assign a Class of Service that allows Voice Mail Message Notification.

Restrictions

- ④ The following numbers can be registered as allowable mailbox numbers for up to a maximum of 200 Voice Mailboxes.
 - 2-Digit 10~99
 - 3-Digit 100~999
 - 4-Digit 1000~999
- ④ Voice Mail Message Waiting has priority over any other state of the flashing line key or One Touch Key.
- ④ When retrieving voice mail messages by pressing a flashing Voice Mail Message Key, voice mail Softkeys are not available. The user may retrieve their messages by following the voice prompts.













General

- ④ The state of a One Touch or Feature Access key is indicated by the red LED as follows:
 - On Steady - Registered Box Number Station is busy.
 - Flashing 0.25 ON / 0.25 OFF - Registered station is in Call Forward All Calls or Do Not Disturb mode.
 - Flashing 0.5 ON / 0.5 OFF - Registered station was set by pressing the Function key.
 - Fast Flash 0.125 ON / 0.125 OFF - Mailbox contains an unplayed message.
 - OFF - Station is idle or Voice Mailbox is empty.
- ④ When the Mailbox registered for multiple Line Keys or One Touch Keys contains a message, all programmed keys flash to indicate that the mailbox contains an unplayed message.
- ④ This feature also supports external Analogue Voice Mail Systems.
- ④ When the user of an invalid system station with a mailbox number assigned to a Feature Access or One Touch key presses the One Touch or Feature Access key while the LED is off, ERROR is displayed and an error tone is generated.
- ④ When the user of an invalid system station with a mailbox number assigned to a Feature Access or One Touch key presses the One Touch or Feature Access key while the LED indicates Message Waiting, the caller is logged into that mailbox.
- ④ When the user of a valid system station with a mailbox number assigned to a Feature Access or One Touch key presses the One Touch or Feature Access key while the LED indicates Message Waiting, an internal call is placed to that station.

RELATED FEATURES

Feature Number	Feature Name
D-7	Digital Voice Mail
S-14	Station Hunting
U-5	User Programming Ability

GUIDE TO FEATURE PROGRAMMING

Order and Shortcut	System Data Name	Memory Block	Function	1-8-07 Attendant Page-Line Key	1-8-08 Station Page-Line Key
 +BS	Telephone Type Assignment	7-2			
 +BTM	Multiline Terminal Type Selection	4-50			
 +BTS	Class of Service (Station) Feature Selection 2	1-8-08			6-2
 +BTT	Station to Class of Service Feature Assignment	4-17			
 +BN	Line Key Selection	2-05			
 +BN	Line Key Selection for Tenant Mode	2-06			
 +BTM	Line Key Selection for Telephone Mode	4-12			
 +BTD	Attendant Add-On Console Key Selection	1-6-05			
 +AV	Voice Mail Quick Transfer Master Hunt Number	1-8-26			
 +BS	Station Number Assignment	4-10			
 +BTT	Intercom Master Hunt Number	4-14			
 +BTT	Intercom Master Hunt Number Forward Assignment	4-15			

Voice Over Internet Protocol (VoIP)

V-3

FEATURE DESCRIPTION

Voice Over IP sends the real time voice/fax over the corporate LAN or WAN. The voice from the telephone is digitised and then put into packets to be sent over a network using Internet protocol.

Savings in the telephony charges for calls between two KTSs and using the LAN/WAN infrastructure to its full capacity are advantages in having VoIP for the Xen IPK system.

The IPT(4)/(8)-U() ETU is an optional interface that can combine trunk and Tie line calls into Gateway trunks that can operate in the following operating modes:

- COI
- COID
- DID
- TLI

Depending on the requirements and resource allocation in the LAN/WAN/Internet, the IPT(4)/(8)-U() ETU can be configured to use any of the following voice compressions:

- G.711 A-Law — 64k Bandwidth
- G.723 — 5.3k/6.3k Bandwidth
- G.729(a) — 8k Bandwidth

The IPT(4)/(8)-U() ETU is assigned as a two-port TLI(2)-U() ETU, four-port DID(4)/COI(4)/COID(4)-U() ETU, or an eight-port COI(8)/COID(8)-U() ETU and can be installed in any interface slot. The LAN/WAN or internet connection is provided by a 10/100 Base T Ethernet.

 The ETU operating mode can be configured per ETU, but not per port.

SYSTEM AVAILABILITY

Terminal Type

All terminals.

Required Components

IPT(4)/(8)-U() ETU

OPERATING PROCEDURES

Use any combination of manual dialling, Save and Repeat, Save and Store, Last Number Redial, Station Speed Dial and System Speed Dial.

SERVICE CONDITIONS

Data Assignment

- Memory Block 1-1-59, (Synchronous Ringing Selection), must be set to NO when the IPT(4)/(8)-U() ETU is used as a COI/COID ETU.

General

- The IPT(4)/(8)-U() ETU can communicate only with another IPT(4)/(8)-U() ETU that may reside on a remote Xen IPK System.
- The LIVE LED flashes when the ETU is receiving power from the KSU.
- Two LEDs on the RJ45 Connector indicate the Ethernet status. A yellow LED indicates the Ethernet Link is up, and a blinking green LED indicates activity.
- Eight STATUS LEDs are provided to indicate the status of an associated trunk or channel when COID or DID mode is selected. Indications are as follows:

Trunk Status	LED for COID	LED for DID
Not installed	Off	Off
Idle	Off	Off
Incoming	Off	On
Busy	On	On

- A two-colour LED is provided to show status of all VoIP Trunks. When an error occurs, the sequence stops and the error can be determined by the table below:

Trunk Status	LED Condition	Error Location
Power On	Off	BIOS, Hardware
Start DSP Download	Red	DSP Driver
Successful DSP download	Red & Green	DSP Download
Application Successfully Started	Green	Application Loading





COI/COID Mode

- ☎ Sixty-four trunks (Loop Start, E&M Tie Lines, and DID Trunks) can be installed in a Xen IPK Expanded system, or 16 trunks in a Xen IPK Basic system.

RELATED FEATURES

Feature Number	Feature Name
C-21	CO/PBX, Tie Line Digit Restriction
D-8	Direct Inward Dialling (DID)
E-3	E&M Tie Lines (4-Wire)
L-5	Loop Start TrunksLoop Start Trunks
U-2	Uniform Numbering Network

GUIDE TO FEATURE PROGRAMMING

Order and Shortcut	System Data Name	Memory Block	Function	1-8-07 Attendant Page-Line Key	1-8-08 Station Page-Line Key
 +BS	* Card Interface Slot Assignment	7-1			
 +BCT	Trunk Type Selection	3-91			
 +BCT	Trunk-to-Trunk Group Assignment	3-03			
 +BCT	Trunk Name/Number Assignment	3-00			
 +BA	* Access Code (1-, 2-, or 3-Digit) Assignment	1-1-46/47/48	101~ 132		

* When the system is at default this Memory Block **must** be programmed for the feature to be used.

THIS PAGE INTENTIONALLY LEFT BLANK

Voice Over Split

V-4

FEATURE DESCRIPTION

By dialling an Access Code, a station user can voice override the conversation between another station user and another party. When the conversation is interrupted, only the station that received the Voice Over hears it.

SYSTEM AVAILABILITY

Terminal Type

All terminals.

Required Components

None.

OPERATING PROCEDURES

To originate Voice Over from a Multiline Terminal:

1. Receive call waiting tone.
2. Dial Access Code  (default) to Voice Over. Override tone is provided to the called party.
3. Talk to the called station user. (Only the voice of the originator is sent to the called party; the voice of the called party is not sent to the originator.)

To originate Voice Over from a Single Line Telephone:

1. Receive call waiting tone.
2. Dial Access Code  to Voice Over. (An override tone is provided to the called station user.)
3. Talk to the called station user. (Only the voice of the originator is sent to the called party; the voice of the called party is not sent to the originator.)

To answer using a Multiline Terminal (Broker's call):

1. Receive Voice Over.
2. Press **Hold** to answer the calling party. The other party is automatically placed on hold (**Answer** flashes green.)
3. Press **Answer** to switch over to talk to the other party.
4. Talk to the called party.
 - ☞ Repeatedly pressing **Answer** alternates the talk path between both calls.

To answer using a Multiline Terminal (Whisper Page)

1. Receive Voice Over.
2. Press **Feature** + **6** **5** (or a Feature Access key/One-Touch key programmed with the Access Code) to switch over to talk with the calling station user if needed.
3. The called station user can repeat Access Code **Feature** + **6** **5** to switch over to talk with the Voice Over originator while continuing to monitor the other party.

SERVICE CONDITIONS

Data Assignment

- ☞ Voice Over Originate/Answer and Tone Override are allowed or denied (using the Class of Service Station Memory Block). (Default for Originate/Answer and Tone Override: Allowed.)
- ☞ Even if Data Line Security is assigned to a station, Voice Over (Originate/Answer) can be activated. This blocks the override tone from the handset.

Restrictions



- ☞ Voice Over can be accomplished only after receiving a call waiting tone.
- ☞ A Multiline Terminal can receive only one Voice Over at a time.
- ☞ The called Multiline Terminal user cannot answer a Voice Over if an internal call is on hold.
- ☞ Voice Override is not allowed for Add-On Conference calls.

- ④ An attempt to Voice Over a Multiline/Single Line Terminal can be denied for the following reasons:
 - Multiline Terminal is in DND (Do Not Disturb) Mode
 - Automatic Redial is activated
 - During Station Programming
 - During Incoming Ringing
 - During Internal Paging
 - During External Paging
 - During a Conference Call
 - During a Conference Call on Hold
 - Terminal is on Internal Hold
 - Terminal has a call on Internal Hold
 - All Conference channels are busy
 - During Handsfree Answerback

General

- ④ Voice Over to a Single Line Telephone is not recommended because cross talk is inherent in the side tone of analogue telephones.
- ④ Voice Over is cancelled when the following operations are used:
 - The calling party goes on-hook.
 - The called Multiline Terminal user presses the Conference or Transfer key. (The current call is placed on hold. The called party receives an internal dial tone, and the calling party receives a burst tone.)
 - The called Multiline Terminal user presses the Recall or Drop key. (The called party seizes the same outside line. The calling party receives a busy tone.)
- ④ An internal party who is talking with the called Multiline Terminal user presses the Hold key. The called party receives Music On Hold. The calling party receives a call waiting tone.
- ④ When a Multiline Terminal user performs Voice Over, the speech path is one-way from the originator to the destination.
- ④ The Voice Over Access Code can be assigned on a Flexible Programmable Line key or One-Touch key.
- ④ An override tone is sent to both calling and called parties.
- ④ A Single Line Telephone user can receive Voice Over.
- ④ After a Tone Override is heard, Voice Over can be set.
- ④ If a Feature Access key or One-Touch key (programmed with the Whisper Page Access Code) is pressed, the LED lights while responding to the page.
- ④ If a station has a Handsfree Unit programmed, the Voice Over call can be received and answered handsfree.

GUIDE TO FEATURE PROGRAMMING

Order and Shortcut	System Data Name	Memory Block	Function	1-8-07 Attendant Page-Line Key	1-8-08 Station Page-Line Key
 +BTS	Class of Service (Station) Feature Selection 2	1-8-08			1-8, 3-3
 +BTT	Station to Class of Service Feature Assignment	4-17			
 +BA	Intercom Feature Access Code Assignment	1-2-24	006		

Voice Prompt

V-5

FEATURE DESCRIPTION

The Voice Prompt feature provides voice guidance for assisting station users. The voice prompt replaces the call waiting tone and/or internal dial tone.

SYSTEM AVAILABILITY

Terminal Type
All terminals.

Required Components
VRS(4)-U() ETU

OPERATING PROCEDURES

To use this feature:

1. Go off-hook.
2. Listen to the Voice Prompt voice message such as:
Dial 9 to place a CO call.
Dial 0 for Attendant.
Dial 101 for customer service.
3. Dial $\textcircled{1}$ $\textcircled{0}$ $\textcircled{1}$.
4. Instead of a call waiting tone, the Voice Prompt provides a message such as:
This line is in use now.
Please wait for a minute.
Press * if you wish to set a Tone Override.
5. Press $\textcircled{*}$ for the Tone Override.

To record a Voice Prompt message:

1. Go off-hook.
2. Dial the VRS voice message record/verify/erase Access Code.
3. Dial operation:
 - ① Recording
 - ② Confirmation
 - ③ Erasing
4. Dial operation:
 - ② Voice Prompt Message
5. Dial operation:
 - ① Message for Dial Tone
 - ② Message for Call Waiting Tone
6. Record message.
7. Go on-hook.

Note: During Message Recording, the LCD indicates the time remaining for recording the message.

SERVICE CONDITIONS

Data Assignment

- ④ Terminals assigned in Station Class of Service can retrieve, confirm, or clear VRS messages.
- ④ Each station can be programmed in System Programming to receive Voice Prompt messages.

General

- ④ A maximum of two VRS(4)-U() ETUs can be installed in a Xen IPK system for 8 voice playback channels.
- ④ The Voice Prompt message should be recorded by the user.
- ④ Messages are retained for approximately one hour during power outages.
- ④ Voice Prompt can start in the middle of a message if all dial tones or call waiting tone messages are already busy and another station accesses one of these messages.
- ④ Voice Prompt can be generated only on an intercom call.
- ④ The microphone can be used instead of a handset for recording messages.
- ④ If Voice Prompt message is not programmed, and the station is assigned to hear Voice Prompt messages, normal dial tone or call waiting tone is provided.

- ⓘ If you try to record, confirm, or erase a message while it is being played, you hear a busy tone.
- ⓘ If all VRS(4)-U() ETU channels that are recorded with Voice Prompt messages are busy (playing messages other than Voice Prompts or in record mode), then normal dial tone or a call waiting tone is heard.
- ⓘ Previously recorded Voice Prompt messages are erased when a new message is recorded.
- ⓘ The following chart shows the possible combinations of recording times and the number of messages per VRS(4)-U() ETU channel. Each channel has a maximum of 240 seconds recording time.

Message Length	Number of Messages
15 sec.	16
30 sec.	8
60 sec.	4
120 sec.	2

GUIDE TO FEATURE PROGRAMMING

Order and Shortcut	System Data Name	Memory Block	Function	1-8-07 Attendant Page-Line Key	1-8-08 Station Page-Line Key
+AR	VRS Message Recording Time Selection	1-8-12			
+AR	* VRS Message Function Assignment	1-8-13			
+AR	Voice Prompt to Tone Assignment	1-8-16			
+BA	* Access Code (1-, 2-, or 3-Digit) Assignment	1-1-46/47/48	501		
+BTS	Class of Service (Station) Feature Selection 2	1-8-08			2-6
+BTT	Station to Class of Service Feature Assignment	4-17			
+BTT	* Voice Prompt Selection	4-36			

* When the system is at default this Memory Block **must** be programmed for the feature to be used.

Doc. No. 8201 - Release 1.0
July 2003

THIS PAGE INTENTIONALLY LEFT BLANK

Feature Access Codes

SECTION 1 GENERAL INFORMATION

The table in this chapter shows the Access Codes used in the system. Some codes are set as system defaults. Others have no default, but are programmable.

Table notes include the following:

- 📞 Installation
- 📞 Access Codes operate on telephones specified during installation.
- 📞 All other notes are self explanatory

Function	Operation	Notes
Microphone ON/OFF	Feature → Dial 1	
System Name Confirmation	Feature → Dial 3 DEF	
Verify Station Number	Feature → Dial 4 GHI	
Confirm Timed Alarm	Feature → Dial 5 JKL 1 → Feature	
Reset Timed Alarm System	Feature → Dial 5 JKL 8 TUV → Feature	Installation
Reset Timed Alarm	Feature → Dial 5 JKL 9 WXYZ → Feature	
Set Do Not Disturb	Feature → Dial 6 MNO 0 OPER → Feature	
Set Call Forward - All Calls	Feature → Dial 6 MNO 0 OPER → Dial XXX → Feature XXX = Station number where call is to be forwarded.	Installation
Set Automatic Trunk-to-Trunk Transfer Mode	Feature → Dial 6 MNO 1 → Dial XX → Feature XX = Incoming Trunk Port Number (01~64) 00 = All Trunks	Installation
Cancel Automatic Trunk-to-Trunk Transfer to Outside Mode	Feature → Dial 6 MNO 2 ABC → Dial XX → Feature XX = Incoming Trunk Port Number (01~64) 00 = All Trunks	Installation
Set Automatic Trunk-to-Trunk Transfer Outgoing Trunk	Feature → Dial 6 MNO 3 DEF → Dial XX → Dial # → Dial YY~Y → Feature XX = Incoming Trunk Port Number (01~64) 00 = All Trunks YY~Y = Transfer Telephone Number (Max 24 Digits)	Installation
Confirm Transfer Number for Automatic Trunk-to-Trunk Transfer	Feature → Dial 6 MNO 4 GHI → Dial XX → Feature XX = Trunk Port Number (01~64)	Installation

Function	Operation	Notes
Serial Port Verification	[Feature] → 6 _{MNO} 5 _{JKL} → XXXX = PYY/SZZ is displayed XXXX = Extension Number YY = Physical Port Number ZZ = Serial Port Number	Used to find the Serial Port number for Electra Stat.
Cancel Call Forward - All Calls by System	[Feature] → Dial 6 _{MNO} 8 _{TUV} → [Feature]	Installation
Cancel Do Not Disturb/Call Forward - All Calls	[Feature] → Dial 6 _{MNO} 9 _{WXYZ} → [Feature]	Installation
Set Customised Message Display	[Feature] → Dial 7 _{PQRS} 0 _{OPER} → Dial * → Dial # → [Dial XX:XX, YY:YY] → [Feature] * Selects display # Sets Display XX:XX = Date of Return YY:YY = Time of Return Optional Operations are enclosed in []	
Cancel Customised Message Display by System	[Feature] → Dial 7 _{PQRS} 8 _{TUV} → [Feature]	Installation
Cancel Customised Message Display	[Feature] → Dial 7 _{PQRS} 9 _{WXYZ} → [Feature]	
Set/Cancel Night Mode Switch (System)	[Feature] → Dial 8 _{TUV} 0 _{OPER} → [Feature]	Installation Attendant Only
Set Automated Attendant/DISA Mode	[Feature] → Dial 8 _{TUV} 1 → Dial XX → [Feature] XX = Incoming Trunk Port Number (01~64) 00 = All Trunks	Installation
Cancel Automated Attendant/DISA Mode	[Feature] → Dial 8 _{TUV} 2 _{ABC} → Dial XX → [Feature] XX = Incoming Trunk Port Number (01~64) 00 = All Trunks	Installation
Set/Cancel Night Mode Switch (Tenant)	[Feature] → Dial 8 _{TUV} 5 _{JKL} → Dial XX → [Feature] XX = Tenant Number (00~47)	Installation
Set/Cancel Weekend Mode Switch (Tenant)	[Feature] → Dial 8 _{TUV} 6 _{MNO} → Dial XX → [Feature] XX = Tenant Number (00~47)	Installation
Background Music On/Off	[Feature] → Dial 2 _{ABC} 6 _{MNO}	
Cancel Callback Message by System	[Feature] → Dial 8 _{TUV} 8 _{TUV} → [Feature]	
Cancel [Feature] LED	[Feature] → Dial 9 _{WXYZ} 9 _{WXYZ} → [Feature]	

Function	Operation	Notes
Program System Speed Dial Buffer Number	<p>[Feature] → [Feature] → Dial XXX → Dial YYY → Dial ZZ~Z → [Hold] → Dial XX~X] → [Feature]</p> <p>XXX = Speed Dial buffer Number (00~79/000~999) YYY = Access Code (Max 3 Digits) ZZ~Z = Telephone Number (Max 24 Digits) xx~x = Name of other Party (Max 13 letters)</p> <p>Optional Operations are enclosed in []</p>	
Program Station Speed Dial Buffer Number	<p>[Feature] → [Feature] → Dial XX → Dial YYY → Dial ZZ~Z → [Hold] → Dial XX~X] → [Feature]</p> <p>XX = Speed Dial buffer Number (80~99) YYY = Access Code (Max 3 Digits) ZZ~Z = Telephone Number (Max 24 Digits) xx~x = Name of other Party (Max 13 letters)</p> <p>Optional Operations are enclosed in []</p>	100-Memory Buffer Allocation only
Confirm System Speed Dial Number	<p>[Feature] → [Redial] → Dial XXX</p> <p>XXX = Speed Dial Buffer Number (00~79/000~999)</p>	
Confirm Station Speed Dial Number	<p>[Feature] → [Redial] → Dial XX</p> <p>XX = Speed Dial buffer Number (80~99)</p>	100-Memory Buffer Allocation only
Cancel System Speed Dial Number	<p>[Feature] → [Redial] → Dial XXX → [Feature]</p> <p>XXX = Speed Dial Buffer Number (00~79/000~999)</p>	Installation
Cancel Station Speed Dial Number	<p>[Feature] → [Redial] → Dial XX → [Feature]</p> <p>XX = Speed Dial buffer Number (80~99)</p>	100-Memory Buffer Allocation only
Place a Call - Speed Dial	<p>[Redial] → Dial XXX</p> <p>XXX = Speed Dial Buffer Number (00~79/000~999)</p>	
Confirm Last Number Dialed Memory	<p>[Conf] → [Redial] → Dial * </p>	
Place a Call Using Store & Repeat/Save & Repeat	<p>[Redial] → Dial # </p>	
Set/Cancel Answer Preset (Ringing Line Preference)	<p>[Feature] → [Answer]</p>	
Last Number Dialed Memory to a Station Speed Dial Buffer Number	<p>[Feature] → [Redial] → Dial XX → [Redial] → [Feature]</p> <p>XX = Speed Dial buffer Number (80~99)</p>	100-Memory Buffer Allocation only
Program Feature Access Keys for DSS/BLF	<p>[Feature] → [Redial] → Feature Access Key → Dial 1 → Dial YYYY → [Dial 1] → [Feature]</p> <p>YYYY = Station number (2, 3, or 4 digits) [Dial 1] switches between voice and tone.</p>	Installation 100-Memory Buffer Allocation only

Doc. No. 8201 - Release 1.0
July 2003

Function	Operation	Notes
Program Feature Access Keys for Station Speed Dial	<p>[Feature] → [Redial] → Feature Access Key → Dial $\text{\textcircled{0}}$ → Dial Y YYY → Dial ZZ~Z → [Hold → Dial XX~X] → [Feature] YYYY = CO/PBX Access code (Max 4 digits) ZZ~Z = Telephone number to be stored (Max 16 digits) XX~X = Name stored using the character Code (Max 13 characters)</p> <p>Optional operations are enclosed in []</p>	<p>Installation</p> <p>100-Memory Buffer Allocation only</p>
Program Feature Access Keys for Nesting Dial	<p>[Feature] → [Redial] → Feature Access Key → Dial $\text{\textcircled{0}}$ → Dial Y YYY → [Answer → Dial ZZ [Repeat Answer → ZZ up to three times] → [Hold → Dial XX~X] → [Feature] Y YYY = CO/PBX Access code (Max 4 digits) ZZ = System (00~79) or Station (80~99) Speed Dial Buffer Number XX~X = Name stored using the character Code (Max 13 characters)</p> <p>Optional operations are enclosed in []</p>	<p>Installation</p> <p>100-Memory Buffer Allocation only</p>
Program Feature Access Keys for Feature Access	<p>[Feature] → [Redial] → Feature Access Key → Dial $\text{\textcircled{\#}}$ → Dial YY → [Feature] YY = Feature Access Code</p>	<p>Installation</p> <p>100-Memory Buffer Allocation only</p>
Confirm Feature Access Key	[Feature] → Feature Access Key	100-Memory Buffer Allocation only
Cancel Feature Access Key	[Feature] → [Redial] → Feature Access Key → [Feature]	
Place a Call with Feature Access Key	Press Feature Access key programmed for applicable feature.	
Program One-Touch Keys for DSS/BLF	<p>[Feature] → [Redial] → One-Touch Key → Dial $\text{\textcircled{1}}$ → Dial YYYY → [Dial $\text{\textcircled{1}}$] → [Feature] YYYY = Station number (2, 3, or 4 digits) [Dial $\text{\textcircled{1}}$] switches between voice and tone.</p>	
Program One-Touch Keys for Station Speed Dial	<p>[Feature] → [Redial] → One-Touch Key → Dial $\text{\textcircled{0}}$ → Dial Y YYY → Dial ZZ~Z → [Feature] YYYY = CO/PBX Access Code (Max 4 digits) ZZ~Z = Telephone number to be stored (Max 16 digits)</p>	
Program One-Touch Keys for Nesting Dial	<p>[Feature] → [Redial] → One-Touch Key → Dial $\text{\textcircled{0}}$ → Dial Y YYY → [Answer → Dial ZZ [Repeat Answer → ZZ up to three times] → [Feature] Y YYY = CO/PBX Access code (Max 4 digits) ZZ = System (00~79) or Station (80~99) Speed Dial Buffer Number</p> <p>Optional operations are enclosed in []</p>	100-Memory Buffer Allocation only

Function	Operation	Notes
Program One-Touch Keys for Feature Access	Feature → Redial → One-Touch Key → Dial * → Dial YY → Feature YY = Feature Access Code	
Confirm One-Touch Key	Feature → One-Touch Key (→ Feature only if arrow is displayed).	
Cancel One-Touch Key	Feature → Redial → One-Touch Key → Feature	
Place a call with One-Touch Key	Press the One-Touch key programmed for the desired feature.	

THIS PAGE INTENTIONALLY LEFT BLANK